



FEATURES

- 1) 3.0V Operate
- 2) Very Low Power Consumption
- 3) 4-digit LCD Clock (Hour/Minute)
- 4) Date Display (Year/Month/Day/Week/Temp)
- 5) Calendar from 2000-2069
- 6) Alarm Snooze Clock Function
- 7) SNOOZE FUNCTION(5 MINUTE)
- 8) BLACK LIGHT(3 SEC)
- 9) Key-Tone
- 10) Temperature Range: -9.9~70 DegC
Temperature Accuracy: +/-1 DegC
Display Resolution: 0.1 DegC
- 11) Soldering options for Temperature Display Unit (DegC/F)
- 12) Soldering options for multi-language week display
French/Spanish/Italian/English

Power On Date & time mode
Auto calendar from 2000 to 2069



CLK
CAL/SET

Press and hold the key for 2sec
setting Date & Time Mode

The setting sequence will be(Year)--(Month)--(Date)
--(Hour)--(Minute)--(Return to normal display mode)
& the week function is auto changeable



CLK
CAL/SET

CLK
CAL/SET

ADV +
12/24 HR

...

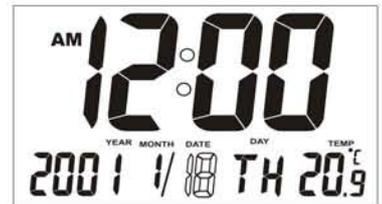

CLK
CAL/SET

CLK
CAL/SET

ADV +
12/24 HR

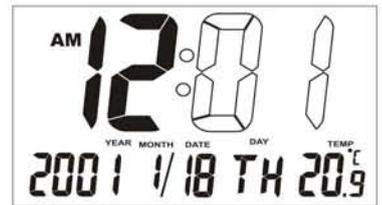

CLK
CAL/SET



ALARM
SET

View Alarm status

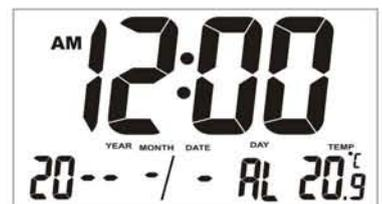

ALARM SET

Press and hold the key 2sec for setting Alarm Date & Time

The setting sequence will be (Month)--(Date) --(Hour)--(Minute)



ADV + 12/24 HR

and

BACK C/F-

To set month means the alarm only active on that month (one month alarm) " - " means disable



ALARM SET

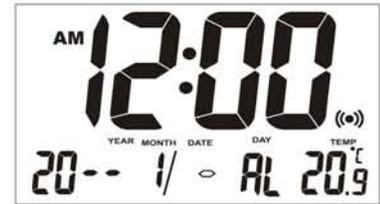

ADV + 12/24 HR

and

BACK C/F-

To set date means the alarm only active on that day (Schedule alarm) " - " means disable



If the setting like the shown diagram , the alarm will only active on that day for every month(Monthly alarm) " - " means disable



The setting like the shown diagram means normal daily alarm



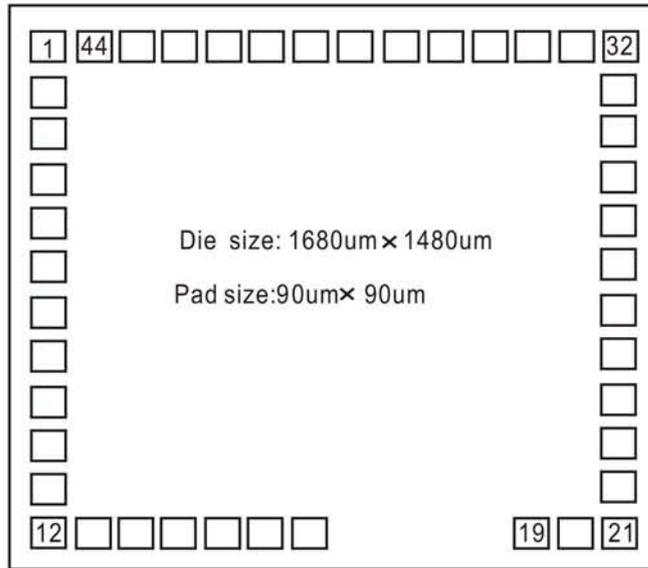

NO	NAME	X	Y	NO	NAME	X	Y
1	BAK	77.50	1399.10	23	SEG9	1602.50	344.70
2	XIN	77.50	1269.10	24	SEG10	1602.50	464.10
3	XOUT	77.50	1154.10	25	SEG11	1602.50	579.10
4	GND	77.50	1039.10	26	SEG12	1602.50	694.10
5	VDD1	77.50	924.10	27	SEG21	1602.50	809.10
6	VDD2	77.50	809.10	28	SEG22	1602.50	924.10
7	VDD3	77.50	694.10	29	SEG23	1602.50	1039.10
8	CUP1	77.50	579.10	30	IOA1	1602.50	1154.10
9	CUP2	77.50	464.10	31	IOA2	1602.50	1269.10
10	COM1	77.50	349.10	32	SEG26	1602.50	1399.10
11	COM2	77.50	224.50	33	SEG27	1472.50	1399.10
12	COM3	77.50	77.50	34	SEG28	1357.50	1399.10
13	COM4	207.50	77.50	35	SEG29	1242.50	1399.10
14	COM5	322.50	77.50	36	SEG30	1127.50	1399.10
15	SEG1	437.50	77.50	37	BZ	1012.50	1399.10
16	SEG2	552.50	77.50	38	SEG32	897.50	1399.10
17	SEG3	667.50	77.50	39	LIGHT	782.50	1399.10
18	SEG4	782.50	77.50	40	KI3	667.50	1399.10
19	SEG5	1366.80	77.50	41	KI4	552.50	1399.10
20	SEG6	1481.80	77.50	42	RESET	437.50	1399.10
21	SEG7	1602.50	77.50	43	INT	322.50	1399.10
22	SEG8	1602.50	224.50	44	N.C.	207.50	1399.10

DL9104

1/5 Duty , 1/3 Bias , 4.5 Vlcd



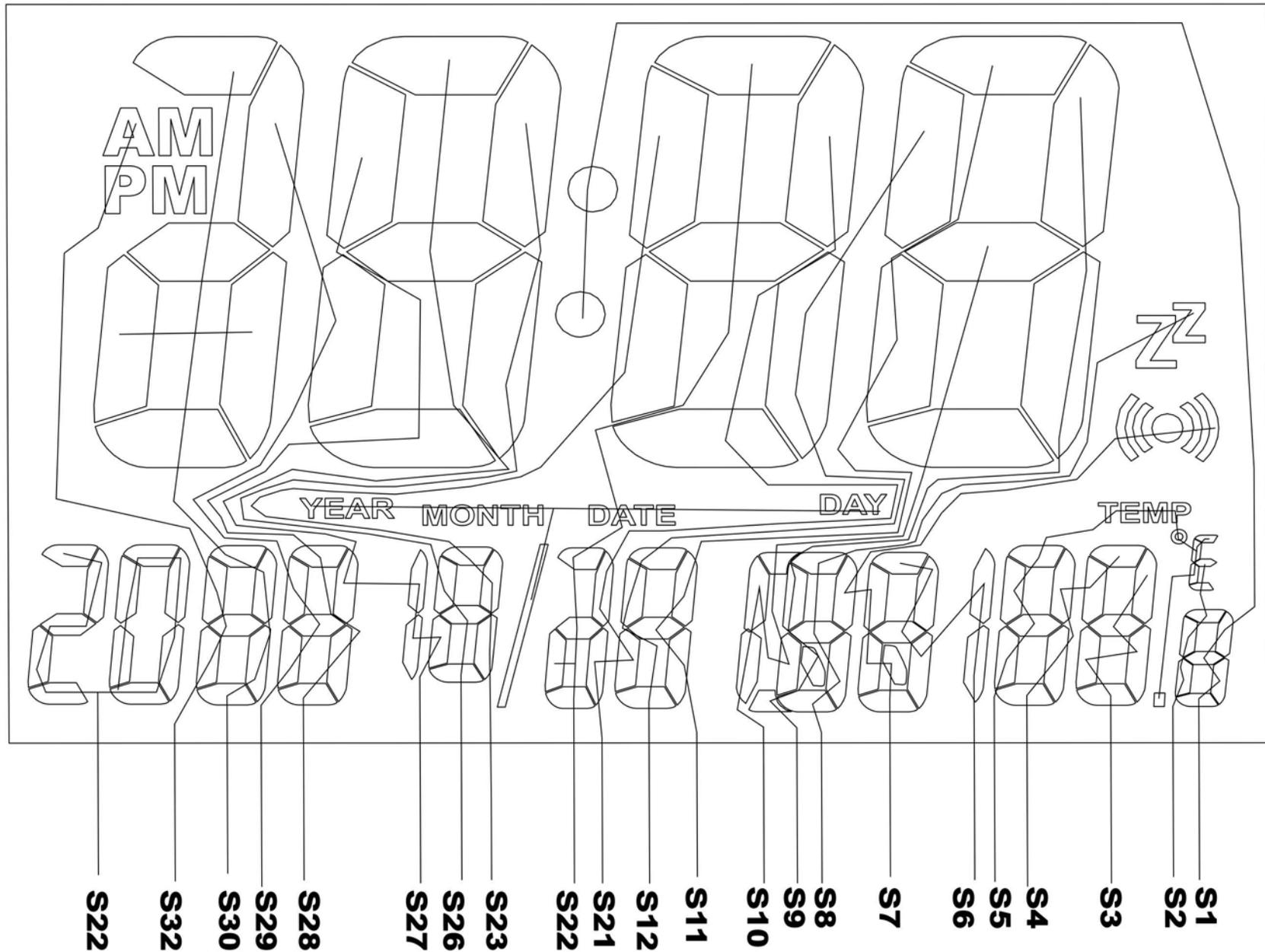

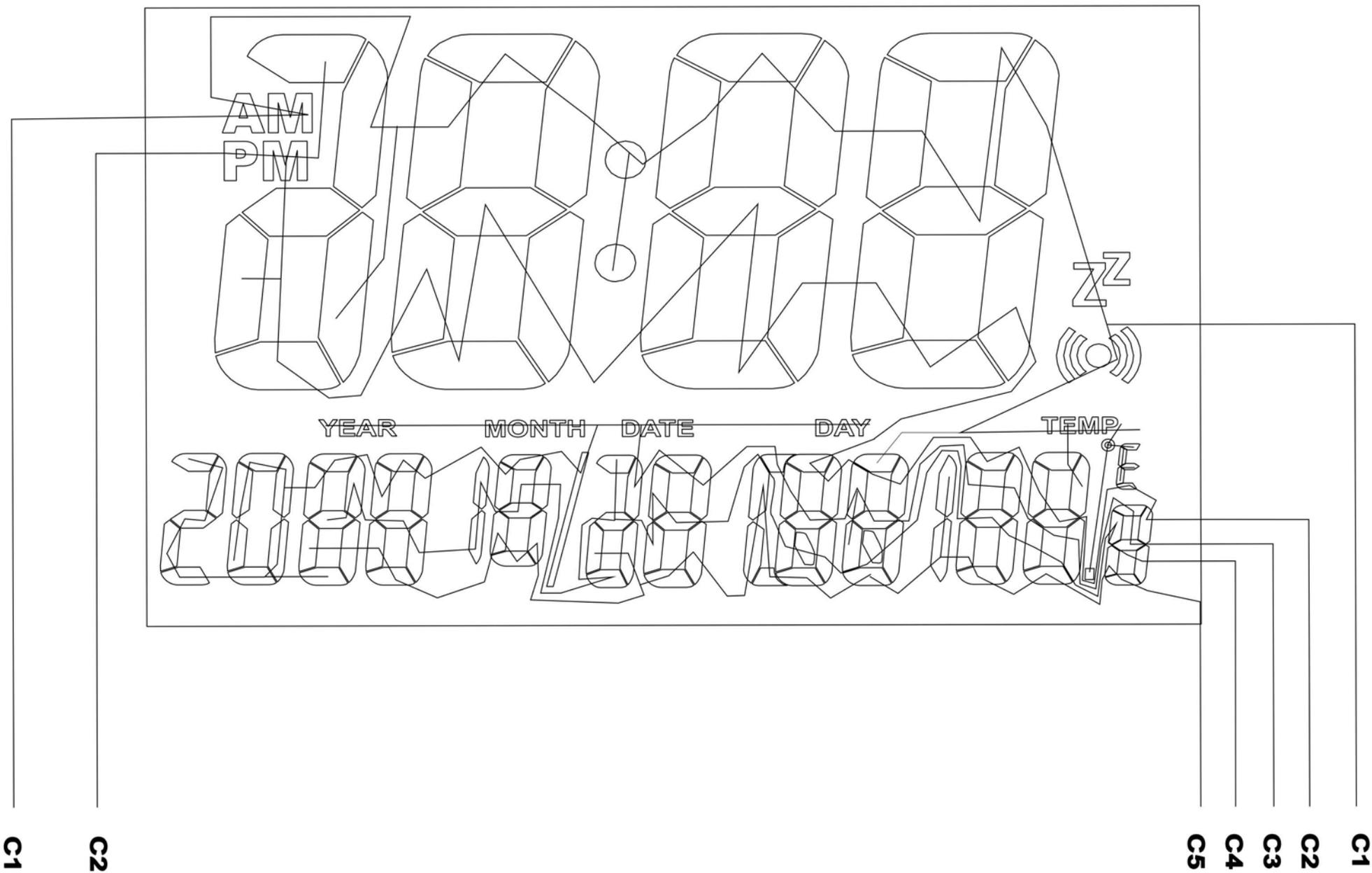

- Option 1 : F / FRA
- Option 2 : C / FRA
- Option 3 : F / SPANISH
- Option 4 : C / SPANISH
- Option 5 : F / ITALIAN
- Option 6 : C / ITALIAN
- Option 7 : F / ENG
- Option 8 : C / ENG

SUNSTAR单片机专用电路 <http://www.icasic.com/> TEL: 0755-83387030 FAX: 0755-83376182 E-MAIL: szss20@163.com

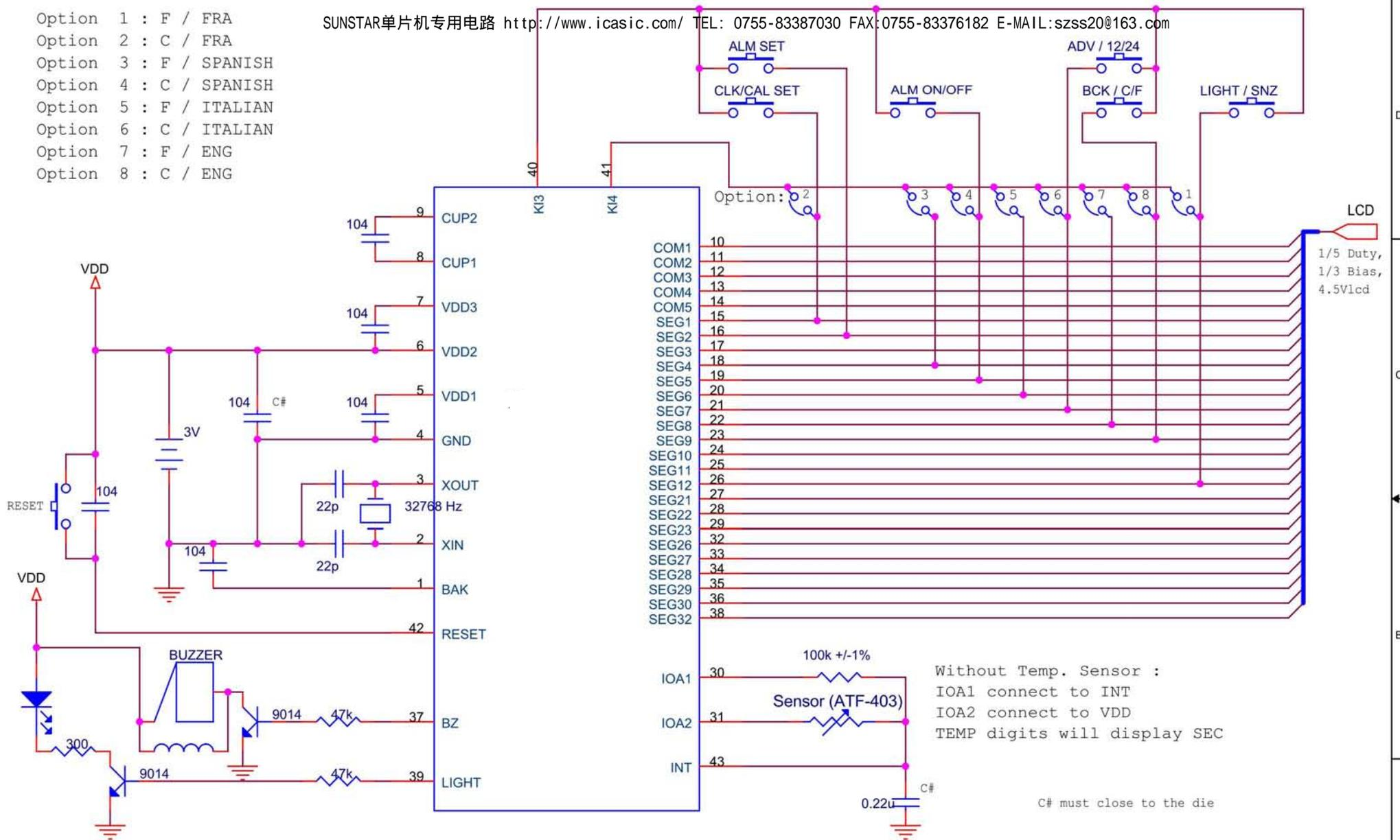

Without Temp. Sensor :
 IOA1 connect to INT
 IOA2 connect to VDD
 TEMP digits will display SEC

C# must close to the die

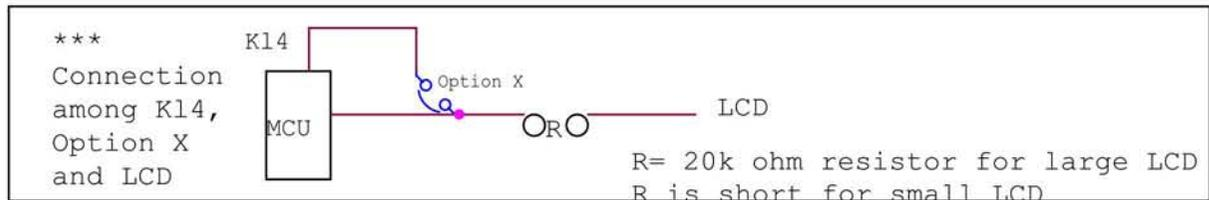

Title DL9104		
Size A	Document Number	Rev 1.0

SUNSTAR单片机专用电路 <http://www.icasic.com/> TEL: 0755-83387030 FAX: 0755-83376182 E-MAIL: szss20@163.com