

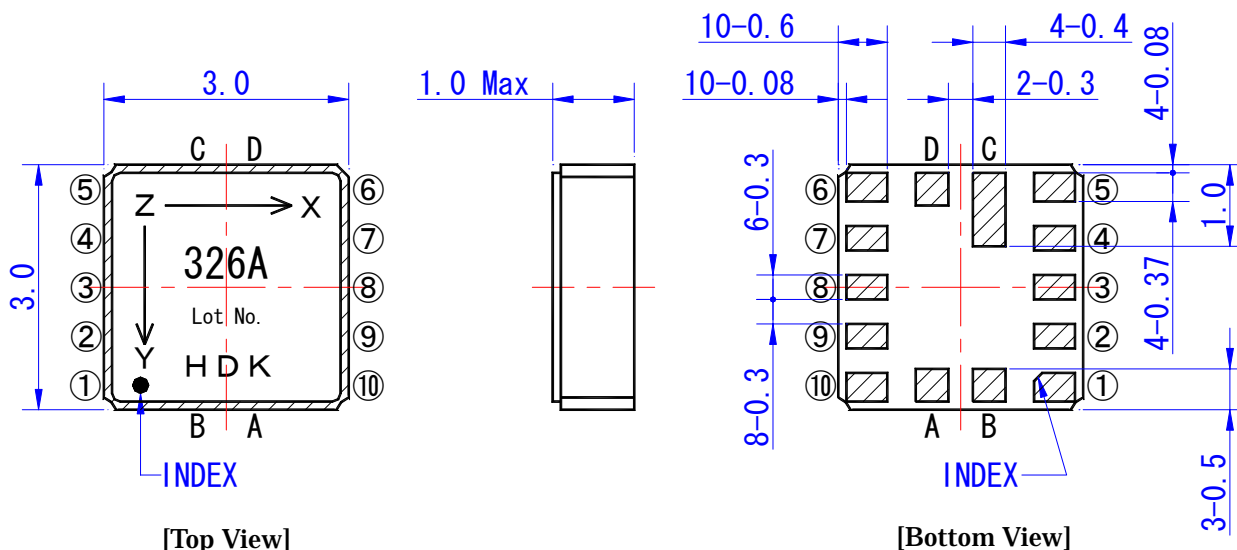

Piezoresistive 3-Axis Acceleration Sensor

HAAM-326A

Outline & Dimensions



Terminal Assignment

No	Pin	Function
1	GND	Ground
2	STANBY	L:Standby / H:Operating
3	INT2 *1	Interrupt Signal 2 When one of either X or Y or Z output exceeds preset threshold (1.5G), this terminal outputs High. Otherwise, it stays Low.
4	INT1 *1	Interrupt Signal 1 When all X, Y, Z outputs go below set threshold (0.4G), this terminal outputs High. Otherwise, it stays Low.
5	NC	
6	VDD	Power Supply
7	LCA	Connect capacitor for internal circuit.
8	X OUT	Analog Output X
9	Y OUT	Analog Output Y
10	Z OUT	Analog Output Z

*1 : Interrupt thresholds are set up individually at our factory.

*2 : Please leave A~D unconnected.



Piezoresistive 3-Axis Acceleration Sensor

HAAM-326A

■ Specification

Item	Rating			Unit	Note
	Min	Typ	Max		
Operating Condition					
Storage Temperature Range	-40		85	°C	
Operating Temperature Range	-25		75	°C	
Supply Voltage	2.2		3.6	V	Ratiometric
Supply Current		0.7	1	mA	at Mode A, Vdd=3.0V at Mode B, Vdd=3.0V
Supply Current at Standby Mode		1	5	uA	
Turn-on Time (at C=0.01uF)		2		msec	Until it becomes 99%
Shock Resistance	5000			G	
Electrical Characteristics (Ta=25°C, Vdd=3.0V)					
Rated Acceleration	-3		3	G	
Offset Voltage	1.425	1.5	1.575	V	Ratiometric against Supply Voltage
Offset Temperature Characteristics	-10		10	% FS/G	△ from 25°C
Sensitivity	297	330	363	mV/G	Ratiometric against Supply Voltage
Linearity of sensitivity	-1		1	% FS	
Sensitivity Temperature Characteristics	-3		3	% FS/G	△ from 25°C
Cross-Axis Sensitivity	-5		5	%	
Resonant Frequency	DC		500 250	Hz	at Mode A at Mode B

■ Block Diagram

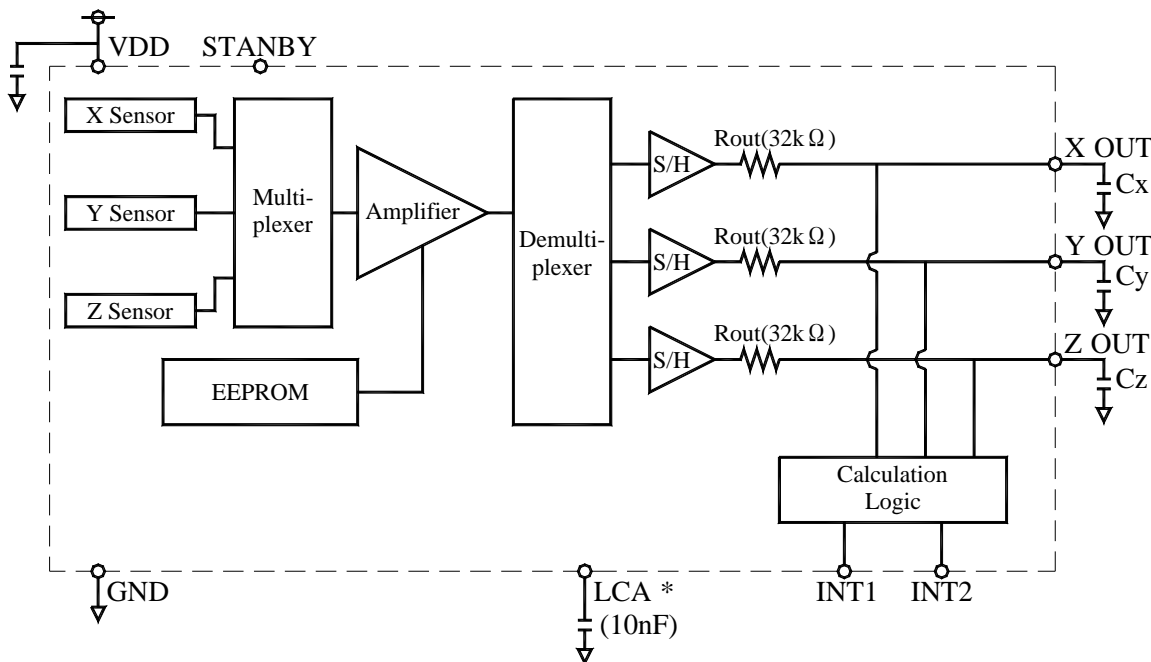

*Please connect 10nF (tentative value) capacitor to LCA for use.