

# MLX90242

## Linear Hall Effect Sensor

### Features and Benefits

- Quad Switched Hall Plate / Chopper Stabilized Amplifier
- Ratiometric Output for A/D Interface
- Low Quiescent Voltage Thermal Drift
- Small Plastic Packages (TSOT, TO-92)
- RoHS compliant TSOT package

### Applications

- Linear Position Sensing
- Rotary Position Sensing
- Current Sensing

### Ordering Code

Product Code	Temperature Code	Package Code	Option Code	Packing Form Code
MLX90242	L	UA	GAA-000	BU
MLX90242	L	UA	GAA-000	RE
MLX90242	L	UC	GAA-000	WB
MLX90242	E	SE	GAA-000	RE
MLX90242	E	SE	GDA-000	RE
MLX90242	E	UC	GAA-000	WB

### Legend:

Temperature Code:	L for Temperature Range -40 °C to 150 °C E for Temperature Range -40 °C to 85 °C
Package Code:	SE for TSOT, UA for TO-92, UC for Die on wafer
Option Code:	AAA-xxx: Die version xxx-000: Standard version
Packing Form:	RE for Reel BU for Bulk WB for Waferbox
Ordering example:	MLX90242LUA-GAA-000-RE

### 1. Functional Diagram

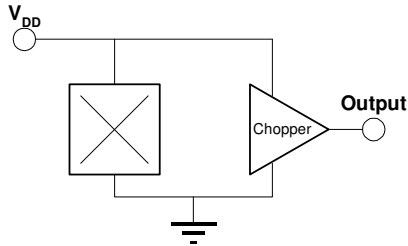

Package	Pin1	Pin2	Pin 3	Slope
TSOT	V <sub>DD</sub>	Out	V <sub>SS</sub>	Positive
UA	V <sub>DD</sub>	V <sub>SS</sub>	Out	Negative

### 2. Description

The MLX90242 is a CMOS Linear Hall Effect sensor IC. It possesses active error correction circuitry which virtually eliminates the offset errors normally associated with analog Hall Effect devices.

The ratiometric output voltage is proportional to the supply voltage. When using the supply voltage as a reference for an A/D converter, fluctuations of  $\pm 10\%$  in supply voltage will not affect accuracy. For a positive slope, the voltage at the output will increase as a South magnetic field is applied to the branded face of the MLX90242. Conversely, the voltage output will decrease in the presence of a North magnetic field. For a negative slope, the voltage at the output will increase as a North magnetic field is applied to the branded face of the MLX90242. Conversely, the voltage output will decrease in the presence of a South magnetic field.

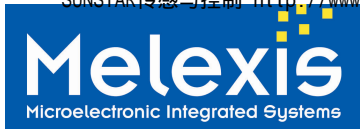

# MLX90242

## Linear Hall Effect Sensor

### TABLE OF CONTENTS

FEATURES AND BENEFITS .....	1
APPLICATIONS.....	1
1. FUNCTIONAL DIAGRAM.....	1-2
2. DESCRIPTION.....	2-2
3. GLOSSARY OF TERMS .....	4
4. ABSOLUTE MAXIMUM RATINGS .....	4
5. MLX90242 ELECTRICAL SPECIFICATIONS .....	5
6. MLX90242 MAGNETIC SPECIFICATIONS .....	5
7. APPLICATIONS INFORMATION.....	6
8. STANDARD INFORMATION REGARDING MANUFACTURABILITY OF MELEXIS PRODUCTS WITH DIFFERENT SOLDERING PROCESSES .....	7
9. ESD PRECAUTIONS.....	7
10. PACKAGE INFORMATION.....	8
10.1. UA PACKAGE.....	8
10.2. TSOT PACKAGE (ROHS COMPLIANT).....	9
11. DISCLAIMER.....	10

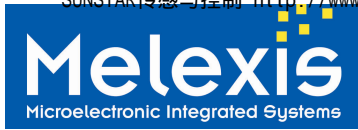

# MLX90242

## Linear Hall Effect Sensor

### 3. Glossary of Terms

- Gauss, Tesla: Two units to quantify a magnetic flux density. Conversion: 1 mT = 10 Gauss
- Voq: Quiescent output voltage. Output voltage for B = 0.

### 4. Absolute Maximum Ratings

Supply Voltage (Over Voltage), V <sub>DD</sub>	7.0 V
Output Current Short to V <sub>DD</sub>	5 mA
Output Current Short to V <sub>SS</sub>	0.5 mA
Output Pin Short to V <sub>SS</sub> Pin	Infinite
Output Over Voltage	8 V
Operating Temperature Range, T <sub>A</sub>	-40°C to 150°C
Storage Temperature Range, T <sub>S</sub>	-55°C to 150°C
Maximum Junction Temp, T <sub>J</sub>	170°C
Magnetic Flux Density	Infinite

Exceeding the absolute maximum ratings may cause permanent damage. Exposure to absolute-maximum-rated conditions for extended periods may affect device reliability.



# MLX90242

## Linear Hall Effect Sensor

### 5. MLX90242 Electrical Specifications

DC Operating Parameters. L:  $T_A = -40$  to  $150^\circ\text{C}$ , E:  $T_A = -40$  to  $85^\circ\text{C}$   
 $V_{DD} = 5.0\text{V}$  (Unless otherwise specified)

Parameter	Symbol	Test Conditions	Min	Typ	Max	Units
Supply Voltage	$V_{DD}$	Operating	4.5	5.0	5.5	V
Supply Current	$I_{DD}$	$B = 0, V_{DD} = 5\text{V}, I_{OUT} = 0$	1.8	2.5	4.5	mA
Output Current	$I_{OUT}$	$V_{DD} = 5\text{V}$ Pull-up = $5\text{ k}\Omega$ , Pull-down = $50\text{ k}\Omega$	-1.0	-	0.1	mA
Quiescent Output Voltage	$V_{OQ}$	$B = 0, T_A = 25^\circ\text{C}$	2.4	2.5	2.6	V
Output Voltage	$V_{OH}$	$V_{DD} = 5\text{V}, I_{OUT} = -1.0\text{ mA}$	4.75			V
Output Voltage	$V_{OL}$	$V_{DD} = 5\text{V}, I_{OUT} = 0.1\text{ mA}$			0.25	V
Response Time	$t_r$	$V_{DD}=5\text{V}, V_{out}$ from $V_{OQ}$ to $V_{OH}/V_{OL}$ without load		400	800	$\mu\text{S}$
Noise (RMS)				5	10	mV
Output Resistance	$R_{OUT}$			20		$\Omega$
Linearity Error	$Le$				0.5	% $V_{DD}$

### 6. MLX90242 Magnetic Specifications

$V_{DD} = 5.0\text{V}$  (Unless otherwise specified)

Parameter	Symbol	MLX90242 LUA-GAA-000			MLX90242 ESE-GDA-000			MLX90242 ESE-GAA-000		
		Min	Typ	Max	Min	Typ	Max	Min	Typ	Max
Thermal $V_{OQ}$ Drift <sup>(1)</sup> (mV)	$\Delta^T V_{OQ}$	-25		25		$\pm 25$ <sup>(2)</sup>			$\pm 25$ <sup>(2)</sup>	
Sensitivity, $T_A = 25^\circ\text{C}$ (mV/mT)	$S$	33.2	39.0	44.9	11.5	15	17.3	33.2	39.0	44.9
TC of Sensitivity (ppm/ $^\circ\text{C}$ )	$TC_S$	430	680	930		680 <sup>(2)</sup>		)	680 <sup>(2)</sup>	

(1)  $B = 0$  Gauss

(2) For TSOT package, TC of Sensitivity and Thermal  $V_{OQ}$  Drift are not fully tested and therefore cannot be specified. Characterization and statistic data can be provided by Melexis upon request.

## 7. Applications Information

C1 and C2 values can be trimmed to satisfied EMC requirements according to the environment (PCB, connectors,...).

The output rise time is affected for large capacitor C2, depending of the couple R1;C2.

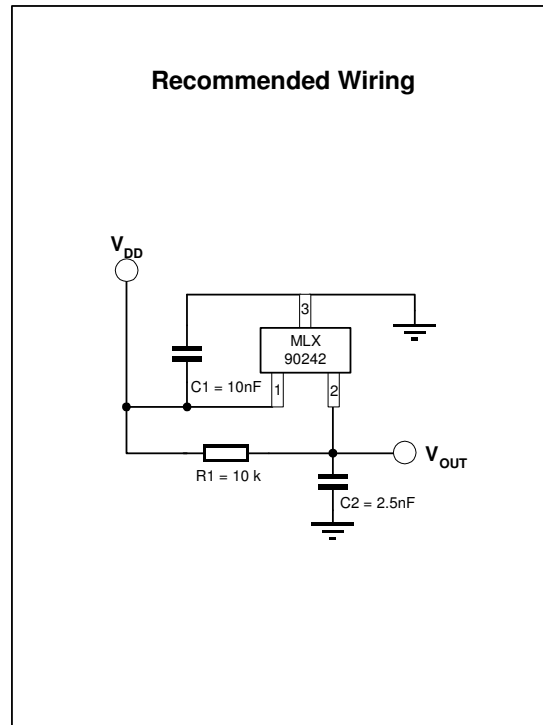

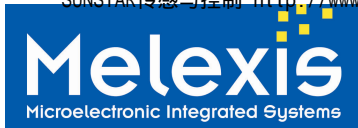

## **8. Standard information regarding manufacturability of Melexis products with different soldering processes**

Our products are classified and qualified regarding soldering technology, solderability and moisture sensitivity level according to following test methods:

### **Reflow Soldering SMD's (Surface Mount Devices)**

- IPC/JEDEC J-STD-020  
Moisture/Reflow Sensitivity Classification for Nonhermetic Solid State Surface Mount Devices (classification reflow profiles according to table 5-2)
- EIA/JEDEC JESD22-A113  
Preconditioning of Nonhermetic Surface Mount Devices Prior to Reliability Testing (reflow profiles according to table 2)

### **Wave Soldering SMD's (Surface Mount Devices) and THD's (Through Hole Devices)**

- EN60749-20  
Resistance of plastic- encapsulated SMD's to combined effect of moisture and soldering heat
- EIA/JEDEC JESD22-B106 and EN60749-15  
Resistance to soldering temperature for through-hole mounted devices

### **Iron Soldering THD's (Through Hole Devices)**

- EN60749-15  
Resistance to soldering temperature for through-hole mounted devices

### **Solderability SMD's (Surface Mount Devices) and THD's (Through Hole Devices)**

- EIA/JEDEC JESD22-B102 and EN60749-21  
Solderability

For all soldering technologies deviating from above mentioned standard conditions (regarding peak temperature, temperature gradient, temperature profile etc) additional classification and qualification tests have to be agreed upon with Melexis.

The application of Wave Soldering for SMD's is allowed only after consulting Melexis regarding assurance of adhesive strength between device and board.

Melexis is contributing to global environmental conservation by promoting **lead free** solutions. For more information on qualifications of **RoHS** compliant products (RoHS = European directive on the Restriction Of the use of certain Hazardous Substances) please visit the quality page on our website:

<http://www.melexis.com/quality.aspx>

## **9. ESD Precautions**

Electronic semiconductor products are sensitive to Electro Static Discharge (ESD). Always observe Electro Static Discharge control procedures whenever handling semiconductor products.



# MLX90242

## Linear Hall Effect Sensor

### 10. Package Information

#### 10.1. UA Package

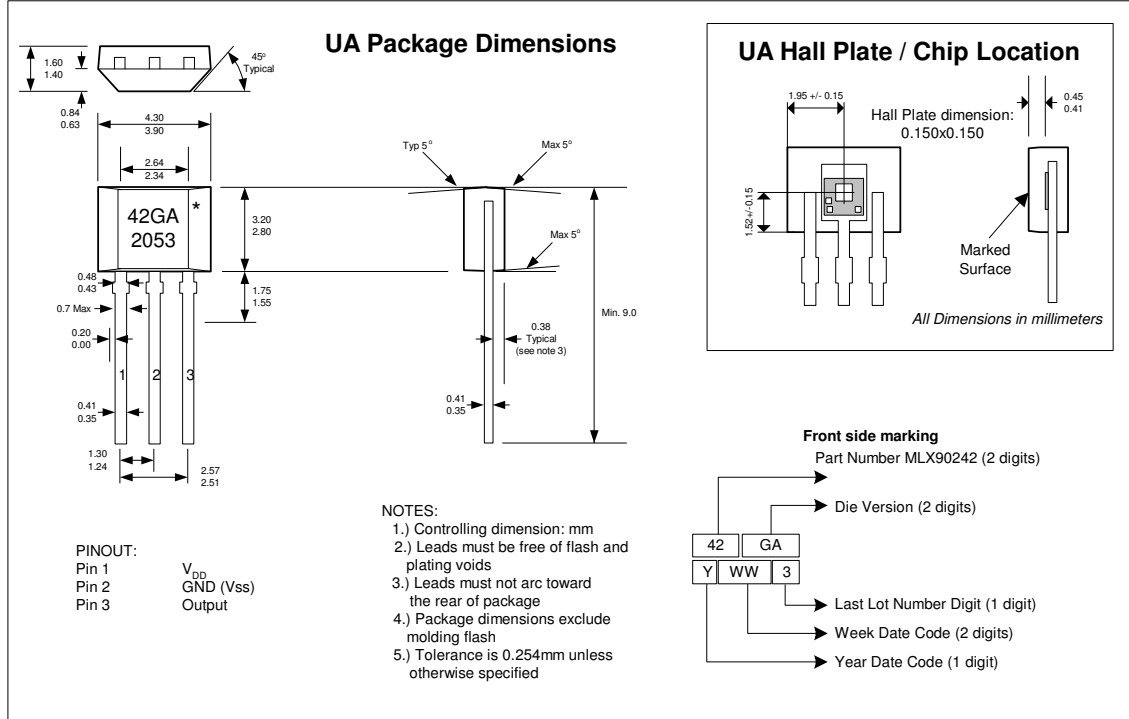





# MLX90242

## Linear Hall Effect Sensor

### 10.2. TSOT Package (RoHS compliant)

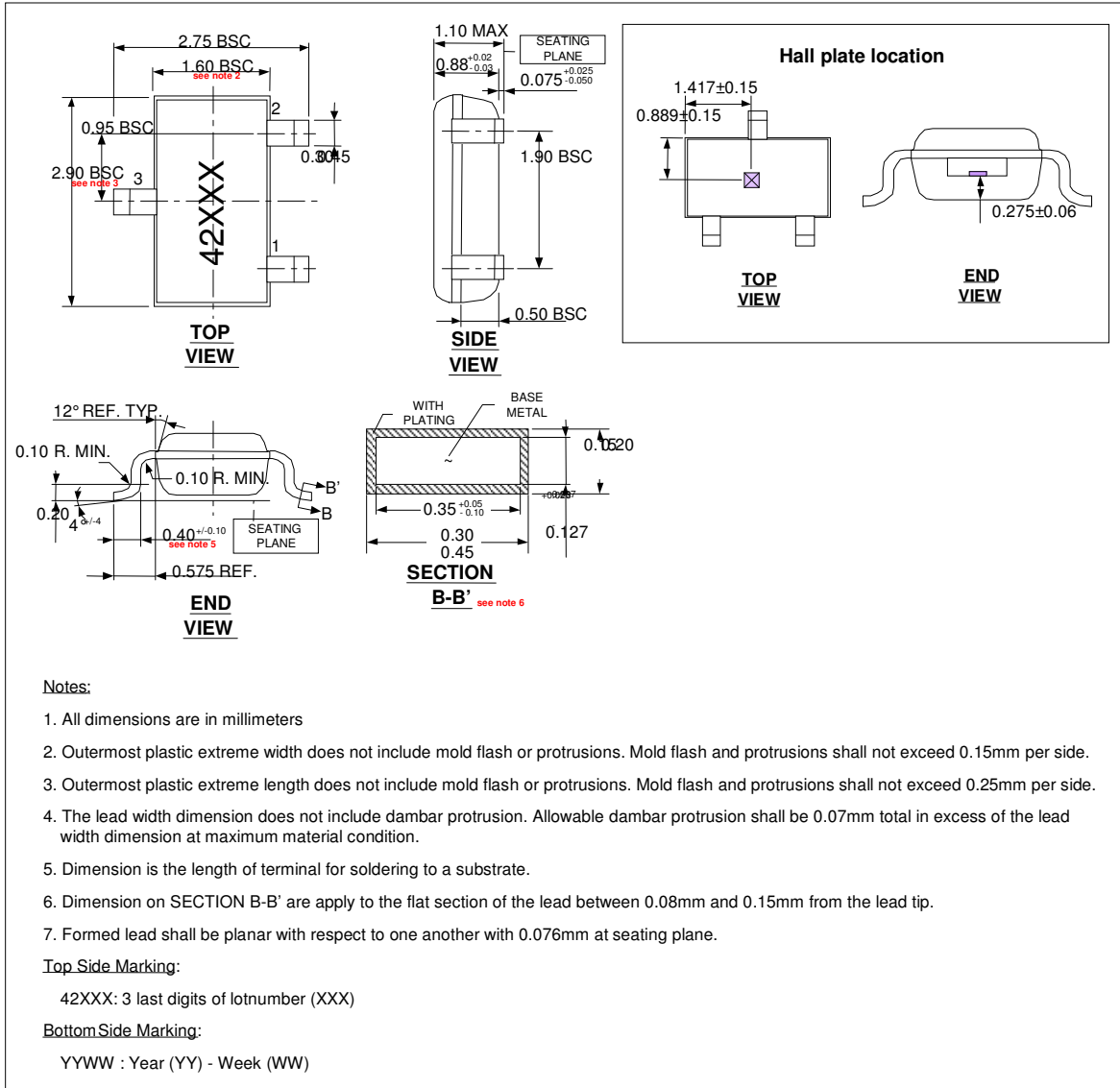



# MLX90242

## Linear Hall Effect Sensor

### 11. Disclaimer

Devices sold by Melexis are covered by the warranty and patent indemnification provisions appearing in its Term of Sale. Melexis makes no warranty, express, statutory, implied, or by description regarding the information set forth herein or regarding the freedom of the described devices from patent infringement. Melexis reserves the right to change specifications and prices at any time and without notice. Therefore, prior to designing this product into a system, it is necessary to check with Melexis for current information. This product is intended for use in normal commercial applications. Applications requiring extended temperature range, unusual environmental requirements, or high reliability applications, such as military, medical life-support or life-sustaining equipment are specifically not recommended without additional processing by Melexis for each application.

The information furnished by Melexis is believed to be correct and accurate. However, Melexis shall not be liable to recipient or any third party for any damages, including but not limited to personal injury, property damage, loss of profits, loss of use, interrupt of business or indirect, special incidental or consequential damages, of any kind, in connection with or arising out of the furnishing, performance or use of the technical data herein. No obligation or liability to recipient or any third party shall arise or flow out of Melexis' rendering of technical or other services.

© 2012 Melexis NV. All rights reserved.

For the latest version of this document, go to our website at  
**[www.melexis.com](http://www.melexis.com)**

Or for additional information contact Melexis Direct:

Europe, Africa, Asia:	America:
Phone: +32 1367 0495	Phone: +1 248 306 5400
E-mail: <a href="mailto:sales_europe@melexis.com">sales_europe@melexis.com</a>	E-mail: <a href="mailto:sales_usa@melexis.com">sales_usa@melexis.com</a>

ISO/TS 16949 and ISO14001 Certified