

LIGHT EMITTING DIODES 1.6÷4.6 μm

Model LED29-PR 2.9 mm 8 mW

•Light Emitting Diodes **LED29-PR** are designed for emitting at a spectral range around 2900 nm. Heterostructures (HS) are grown on InAs substrates. The output emission can be modulated by current flowing in a forward direction.

•Light Emitting Diodes **LED29-PR** are developed for using in optical gas sensors and medical diagnostics. They have stable output power and lifetime more than 10000 hours.

•Related products: **LED29-PR** can be used in optical pair with our photodiodes **PD36**. Our standard **LED Driver** provides power supply of **LED29-PR** in two recommended here regimes (Quasi-CW and Pulsed).

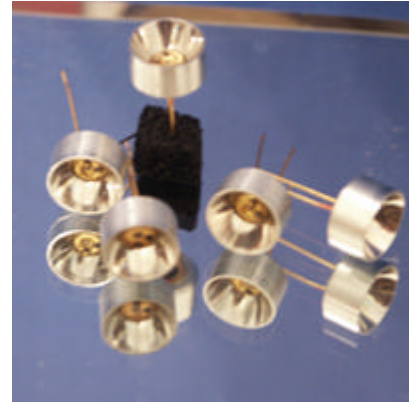

Parameters	Min	Typ	Max
Wavelength, μm	2.80	2.90	3.00
FWHM, μm	0.60	0.70	0.80
Optical Power, μW			
Quasi-CW @ 200 mA	6	8	10
Pulsed@2A	120	150	170
Switching Time, ns	10	30	50
Operating Temperature Range, °C	-240÷+50		
Emitting Area, μm	300x300		
Soldering temperature	260 °C		
Package	TO-18 with Parabolic Reflector		

Recommended regimes of operation

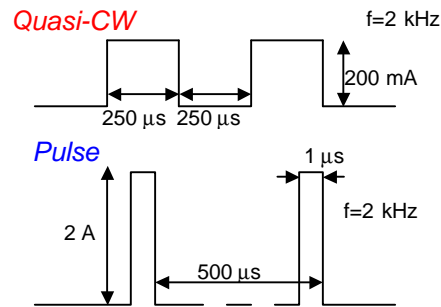

Package TO-18 with Reflector

