

LIGHT EMITTING DIODES 1.6÷4.6 μm

Model LED21-PR 2.15 mm 1.1 mW

•Light Emitting Diodes **LED21-PR** are designed for emitting at a spectral range around 2150 nm. Heterostructures (HS) are grown on GaSb substrates. The output emission can be modulated by current flowing in a forward direction.

•Light Emitting Diodes **LED21-PR** are developed for using in optical gas sensors and medical diagnostics. They have stable output power and lifetime more then 10000 hours.

•Related products: **LED21-PR** can be used in optical pair with our photodiodes **PD24**. Our standard **LED Driver** provides power supply of **LED21-PR** in two recommended here regimes (Quasi-CW and Pulsed).

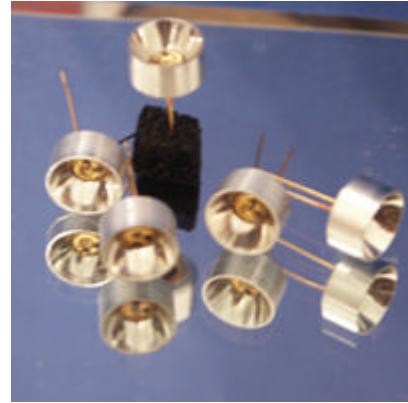

| Parameters | Min | Typ | Max |
|---------------------------------|--------------------------------|------|------|
| Wavelength, μm | 2.10 | 2.15 | 2.19 |
| FWHM, μm | 0.15 | 0.20 | 0.25 |
| Optical Power, mW | | | |
| Quasi-CW @ 200 mA | 0.9 | 1.1 | 1.3 |
| Pulsed@1A | 25 | 28 | 30 |
| Switching Time, ns | 10 | 30 | 50 |
| Operating Temperature Range, °C | -240÷+50 | | |
| Emitting Area, μm | 300x300 | | |
| Soldering temperature | 260 °C | | |
| Package | TO-18 with Parabolic Reflector | | |

Recommended regimes of operation

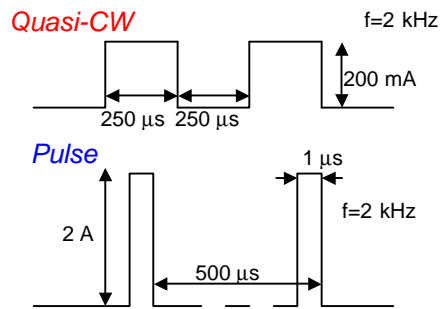

Package TO-18 with Reflector

