

Carbon monoxide (CO) is a by-product of the combustion – especially the incomplete combustion – of many common fuels. Gasoline powered engines, wood-burnings stoves and fireplaces, charcoal grills, kerosene heaters, and improperly vented gas or oil furnaces may produce CO.

This gas is particularly hazardous because it is colourless, tasteless and odourless. The e2v MiCS-5525 is a new micro-fabricated CO sensor designed for CO detection applications, for example alarm systems in residential areas (UL 2034) or cabin air quality control in vehicles. The MiCS-5525 is a low-cost, low power and highly reliable CO detector.

STRUCTURE

The silicon gas sensor structure consists of an accurately micro-machined diaphragm with an embedded heating resistor R_H and the sensing resistor R_S on top. The sensing element is a layer of inorganic n-type metal oxide semiconductor.

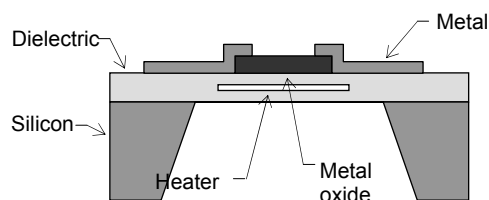

A built-in activated charcoal filter selectively absorbs interfering gases thereby improving the sensor selectivity and preventing possible damage to the sensing layer. The sensor structure is mounted on a 4-pin TO-5 base with a diameter of 9 mm and covered by a nylon overcap, which is 15 mm in height.

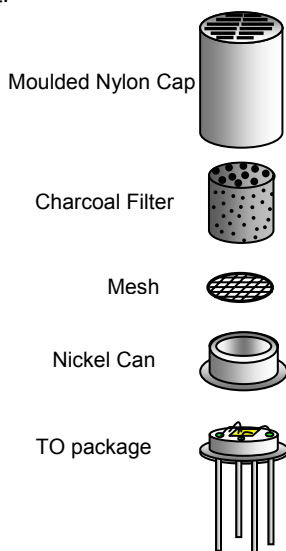

MiCS-5525 sensor

CO DETECTION PRINCIPLE

The semiconducting ionic oxide, MO_{2-x} , undergoes characteristic changes in impedance upon electronic charge transfer (e^-) during catalytic reactions with deoxidising or reducing gases, e.g. combustible gases, CO, HC, NO, present in the ambient atmosphere. In this reaction electrons are transferred from O_2 , present in the ambient air, via the semiconductor to CO, the oxide acts as a heterogeneous catalyst as described below.

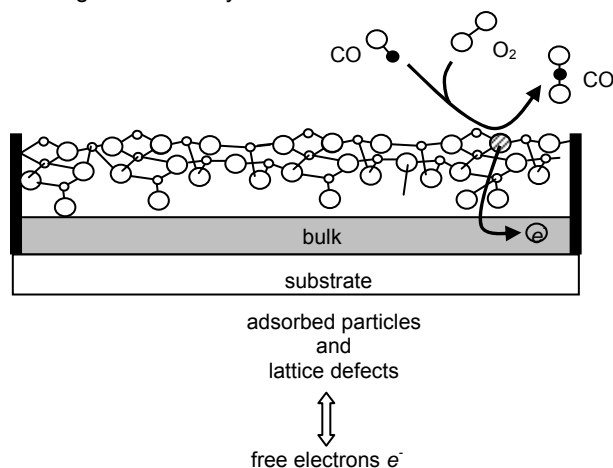

In normal ambient air:

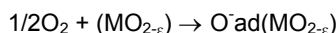

Adsorption reaction.

In the presence of CO:

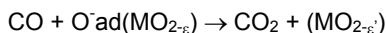

These reduction reactions, which generate free electrons, occur at the surface, and in the bulk of the structure most importantly at grain boundaries. The reaction at the grain boundaries increases the flow of electrons thereby reducing the resistance of the sensing layer (R_S).

Whilst e2v technologies has taken care to ensure the accuracy of the information contained herein it accepts no responsibility for the consequences of any use thereof and also reserves the right to change the specification of goods without notice. e2v technologies accepts no liability beyond the set out in its standard conditions of sale in respect of infringement of third party patents arising from the use of tubes or other devices in accordance with information contained herein.

e2v technologies (uk) limited, Waterhouse Lane, Chelmsford, Essex CM1 2QU United Kingdom Telephone: +44 (0)1245 493493 Facsimile: +44 (0)1245 492492

e-mail: enquiries@e2v.com Internet: www.e2v.com Holding Company: e2v technologies plc

e2v technologies inc. 520 White Plains Road, Suite 450, Tarrytown, NY10591 USA Telephone: (914) 592-6050 Facsimile: (914) 592-5148 e-mail: enquiries@e2vtechnologies.us

© e2v technologies (uk) limited 2009

A1A-MICS_AN3 Version 1, April 2009

Template: DF764388A-2

OPERATING CONDITIONS

The basic characteristics of semiconductor gas sensors are temperature dependent. This is because the basic sensor properties and processes, i.e. the conductivity of the oxide, the adsorption of oxygen, the reaction between the gases and surface oxygen, as described previously, are governed by thermodynamics.

The sensitivity of the sensor to CO is highest compared to other gases at low temperatures (below 150 °C). The sensor is therefore run in this area to maximise the sensor sensitivity and selectivity.

The voltage profile is shown below:

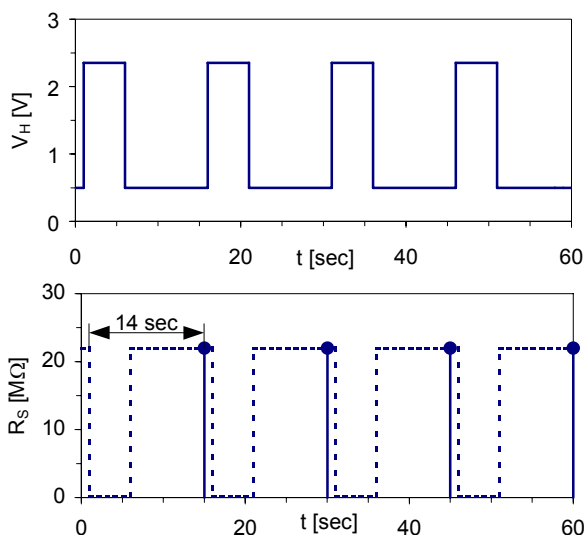

V_H and R_S as a function of time without CO

A sequential voltage mode is applied to the heater resistance in order to heat alternately the sensing element from high to low. A high heater voltage, V_H = 2.35 V, is first applied for 5 seconds followed by a low heater voltage, V_H = 0.5 V, which lasts for 10 seconds as shown in the upper graph. The micro-machined diaphragm allows a low power cycle and a fast thermal response in the order of 20 ms. The high voltage increases the temperature to ~450 °C at which point water vapour and interfering gases are removed from the sensing layer.

Because the sensing resistor has a negative temperature coefficient, its resistive value also changes, in this example from about 20 MΩ (at the higher temperature) to about 10 kΩ at the lower temperature. (see lower graph). The detection of CO is achieved during the low voltage part of the cycle by measuring a single point of the R_S response when the sensor's temperature drops below 100 °C.

The detection points are indicated by the round dots. The measurements are taken after 14 seconds from the start of each operating cycle, at the optimum sensor low temperature point. This is 1 second before switching V_H from 0.5 V back to 2.35 V.

The speed and degree of sensor resistance changes vary depending on the type of gas and the gas concentration. Therefore it is important to detect the sensor signal precisely at a suitable timing as well as applying the specified heater voltage.

Using this cyclical temperature change operation method, high sensitivity to CO with good selectivity and good reproducibility of signal is obtained.

BASIC MEASURING TECHNIQUE

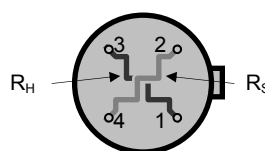

Pin Number	
1	Heater Ground
2	Sensor Pin
3	Heater Power
4	Sensor Pin

Equivalent circuit (top view) of MiCS-5525

The sequential heating voltage V_H is applied to pins 3 and 1, as described opposite. Applying the specified heater voltage profile is needed in order to achieve the optimum sensitivity to the target gas.

Adherence to the voltage profile is required as the sensor can be damaged by voltages over 2.5 V.

The resistance of the sensing layer, R_S, can be calculated as follows.

A load resistor R_L is connected in series with R_S to convert the resistance R_S to a voltage V_{out} between pins 2 and 4. R_S can then be calculated by the following expression:

$$R_S = R_L / (V_{CC} - V_{out}) \cdot V_{out}$$

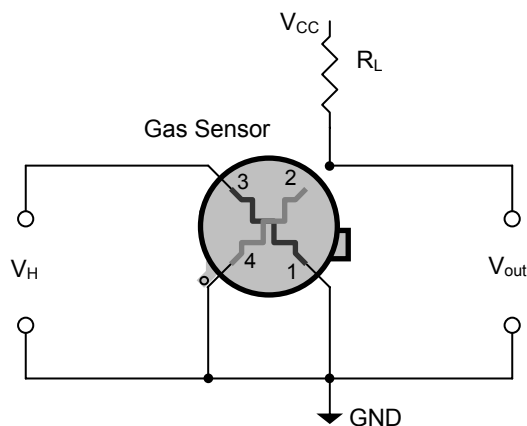

Measurement circuit for CO detection

From a sensitivity standpoint the resistance value for R_L has to be as close as possible to the resistance of the unknown resistor R_S, in this case around 100 kΩ.

To reduce potential errors when reading the V_{out} voltage it is recommended to use a linear low-power CMOS input amplifier of at least 1 GΩ input resistance in the circuit.

The two graphs below and left show an example of the heating voltage V_H (upper graph) and V_{out} (lower graph) versus time. The sensor response V_{out} is shown for gradually increasing CO concentrations.

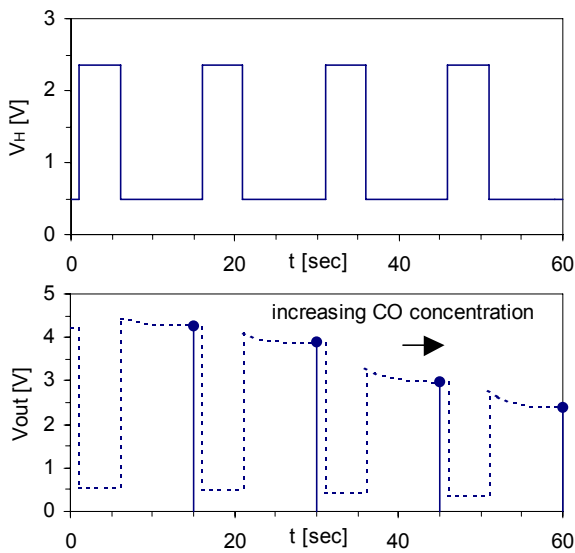

V_H and V_{out} as a function of time with CO

CALIBRATION TECHNIQUE

The sensor response to CO is non-linear showing large changes of R_S at low concentration and a saturating behavior towards higher concentrations of CO as shown by the measured points of a typical sensor on the figure below:

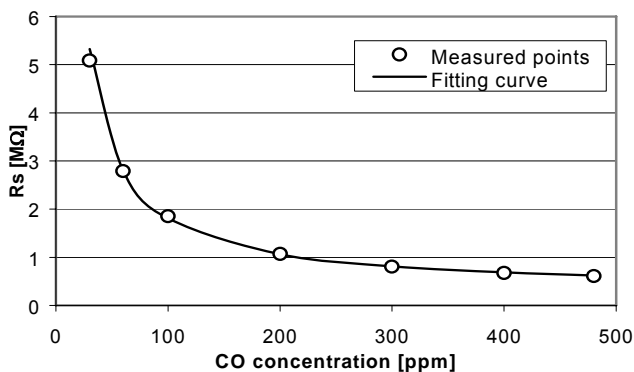

Fitting curve and measured points at 23 °C and 50% RH

It is possible to use a simple fitting calibration curve which can be used to determine the CO concentration detected by the sensor.

The fundamental dependency of the sensor can be described as an inverse function:

$$R_s = a + b/CO$$

Where a is the resistance at infinite level of CO and b describes resistance variation due to CO exposure.

In practice, a does not significantly change between 1000 ppm and 100% volume and as such a can be determined at the 1000 ppm point.

The CO level can then be calculated with the function as follows:

$$CO = b/(R_s - a)$$

Derivation of ' b ' and the sensor response can be done by measuring the sensor responses at two or more points.

The example presented is based on a calibration of the sensor at two points (60 and 400 ppm of CO). Other calibration strategies can be implemented according to the requirements of the specific application.

The derived equation allows calculation of the CO level over a defined range with a low error (less than 5 %).

In an instrument application, the sensor response can then be compared with reference resistance values corresponding with preprogrammed alarm thresholds and integrated over time according the specifications such as UL2034.

PREHEATING TIME

When the MiCS-5525 is used after storage without power, it will be necessary to let the sensor resistance recover the chemical equilibrium with the ambient atmosphere.

The extent of this recovery will depend on the storage conditions and on the operating conditions and atmosphere.

The recommended procedure is to maintain the sensor in the recommended powered operating mode for at least 4 hours before starting measurements.

In order to provide a reliable CO detection level setting (calibration), it is important to adjust alarm level at a stable stage of the sensor resistance.

TEMPERATURE DEPENDENCY OF BASELINE

As with all metal-oxide sensors, the resistance of the MiCS-5525 sensor varies with ambient temperature. The resistance decreases with increasing temperature. Typical behaviour is shown below.

MiCS-5525 CO sensor temperature dependency

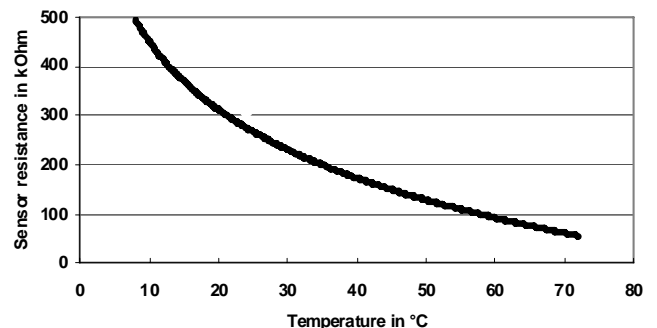

HUMIDITY DEPENDENCY OF RESPONSE

The MiCS-5525 shows a low dependency to the humidity in the commonly found range of 30 to 70% RH and a slight influence of humidity in the extended range 15 to 95 % RH at a temperature of 23 °C.

The figure below shows the influence of humidity for different CO concentrations at room temperature. This shows a low influence of humidity above 20% RH. This means that false alarms are unlikely to be produced by the influence of humidity as the response to humidity is much less than the response to CO.

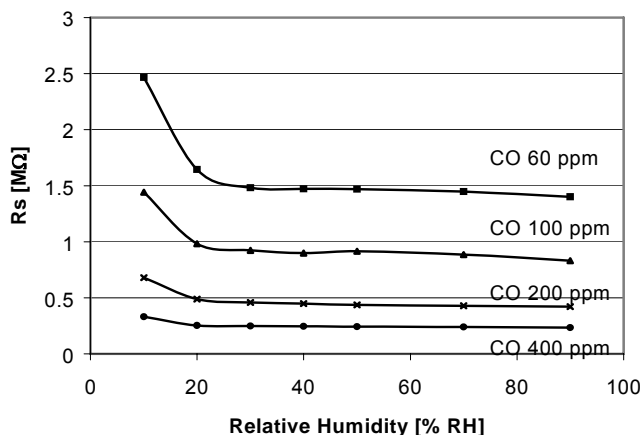

Specific humidity compensation is not necessary for standard applications between 15% to 95% RH.

It is recommended to use the sensor in an atmosphere with at least 15% RH.

TEMPERATURE DEPENDENCY OF GAS RESPONSE

The figure below shows the effect of temperature on the typical sensor sensitivity at ambient temperatures between 0 °C and 50 °C at 55% RH at gas concentrations of 60, 100, 200 and 400 ppm CO. Sensitivity is expressed as the ratio of R_s at 60 ppm/25 °C and at the applied CO concentration and temperature.

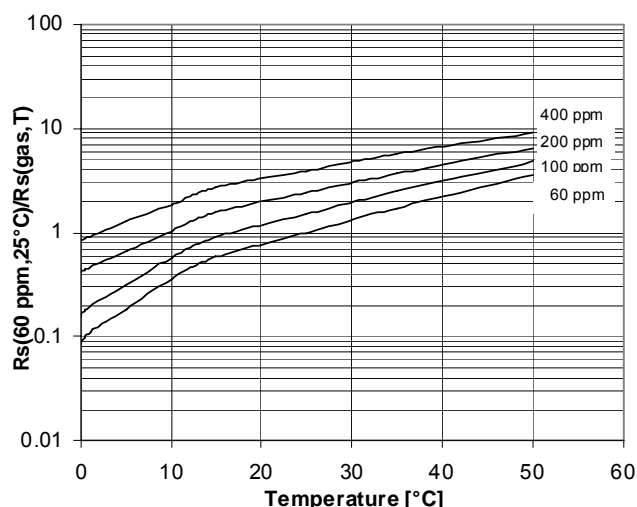

By selecting a suitable temperature compensation method (e.g. using a thermistor and microprocessor programming), reliable CO detection over wide temperature range can be achieved.

This may take form of a Negative Temperature Coefficient thermistor (NTC), which can be placed in series with a load resistor. The voltage across this network can be directed into the A/D input of a microcontroller. After each acquisition cycle (every 15 seconds) the microcontroller will read the voltage over the NTC to monitor the ambient temperature and compensate the error occurring on the reading value of CO.

Care must be taken in positioning the temperature measuring thermistor as close as possible to the CO sensor. The thermistor must be as far away as possible from any heat dissipating electrical component and not in areas where heat could be lost by exposure to gas flows. The aim is for the thermistor to reflect as closely as possible the ambient temperature in contact with the CO sensor.

INTERFERING GASES AND FILTER PERFORMANCE

The UL2034 standard requires that the detector will not alarm when exposed sequentially to 500 ppm methane, 300 ppm butane, 500 ppm heptane, 200 ppm ethyl acetate, 200 ppm isopropyl alcohol and 1000 ppm carbon dioxide during 2 hours. The figure to the right and above shows the effect of the interfering gases when the sensor is exposed to the UL2034 gas concentration.

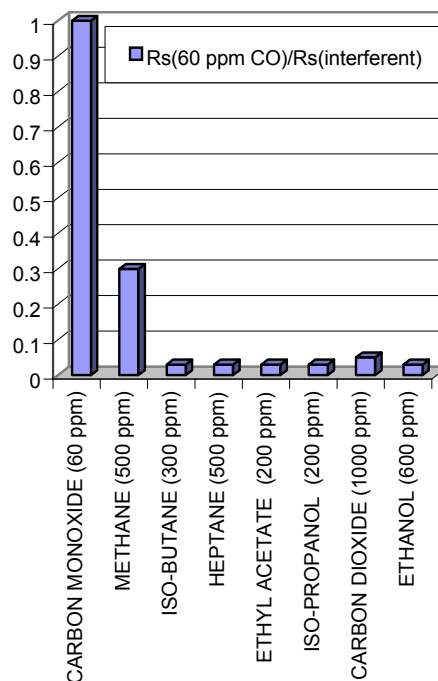

UL2034 Interfering Gases Effect

The value of the ratio R_s (60 ppm CO)/ R_s (interfering gas) demonstrates that there is no risk of false alarm when the detector is calibrated to alarm at 60 ppm CO. In addition to the UL2034 requirements, British Standards 7860 requires that the alarm shall not be activated when the sensor is exposed to 600 ppm of ethanol for 15 minutes. The MiCS-5525 with its active charcoal filter meets this requirement as well.

Exposing the sensor to 500 ppm methane corresponds to an equivalent resistance of approximately 20 ppm carbon monoxide.

Since NO_2 is a strong oxidising gas, resistance of a n-type semiconductor increases under the presence of this gas. The active charcoal filter is also effective to remove the interfering influence from NO_2 .

The active charcoal filter's lifetime under standard using environmental conditions is more than 5 years.

DESTRUCTIVE TESTS

A series of tests was performed to verify the reliability and reproducibility of the manufacturing process. Standard semiconductor integrity tests included:

- Wire pull and ball shear test according with Military Standard 750 Method 2037.
- Die shear strength test according with Military Standard 750 Method 2017.

All the sensor units tested (135 samples from 3 different lots) passed the following tests:

- Internal visual inspections (45 samples from each of the 3 lots).
- Terminal strength test (33 samples).
- Lead finish composition and thickness evaluations (3 samples).

All the sensor units tested were in the test specifications.

Solderability Test

The purpose of this test was to evaluate the ability of the device to be soldered after storage with aging for 8 hours. When compared to reference samples not subjected to this condition, no significant difference was noticed after soldering.

Soldering Heat Test

This test examined the device's structural ability to withstand solder temperature of 260 °C for 10 seconds. When compared to reference samples not subjected to this condition, no significant difference was noticed after soldering.

The sensor must not be wave soldered without protection or exposed to high concentrations of organic solvents

STRUCTURAL TESTS

Structural tests were performed to verify the reliability of the sensor structure itself.

Vibration Tests

This test simulates potential environmental conditions and evaluates package and die integrity. Two sequences were used with unenergised sensors; Sequence 1 used a frequency varied logarithmically from 100 Hz to 2 kHz and then back to 100 Hz (Military Standard 750 Method 2056). The peak acceleration is 20 g. Sensors were tested in this manner for 4 cycles in each axis for 4 minutes each cycle. Sequence 2 used a fixed frequency of 35 Hz and amplitude of 0.25 mm (per UL2034) with 3 axis orientation and a duration of 4 hours per axis.

No defect over the 105 samples (from 3 different lots) tested. When compared to reference samples not subjected to these vibrations, no significant difference can be noticed.

Shock Tests

This test simulates potential environmental conditions and evaluates wire bond and diaphragm integrity. Unenergised sensor units were dropped shocked at 1500 g of force three times in each of six orientations. The duration of each shock was 0.5 ms.

No defect over the 105 samples (from 3 different lots) tested. When compared to reference samples not subjected to these shocks, no significant difference can be noticed.

Variable Ambient Temperature Test

To show the ability of the MiCS-5525 to withstand the effects of high and low temperature representative of shipping and storage, unenergised test samples were subjected to temperature cycling of -40 °C and +85 °C for a total of 1000 cycles.

The dwell time at temperature extreme is 15 minutes, with transfer time between temperature of 5 minutes maximum. The dwell time at each extreme, plus the transfer time define a cycle.

This test accelerates the effects of thermal expansion mismatch among the different components within the die and package.

No defect over the 105 samples (from 3 different lots) tested. When compared to reference samples not subjected to these temperatures extreme, no significant difference can be noticed.

High Temperature Storage Life Test

This test simulates potential shipping and operational conditions and evaluates the product's thermal integrity. Unenergised test samples were subjected to 1000 hours at +70 °C.

No failures were found from the 105 samples (from 3 different lots) tested. When compared to reference samples not subjected to these temperatures extreme, no significant difference can be noticed.

LONG-TERM TESTS

These were performed to verify the long-term gas sensor metrology parameters (sensitive resistance under clean air, synthetic air and CO).

Accelerated Operating Life Test

This test was made in order to accelerate the thermal fatigue of the sensor structure. The test was performed in ambient conditions with the power cycle reduced to 120 ms from 15 seconds in order to obtain an acceleration factor of 125. 95 devices, from 3 different lots, were submitted to 1300 hours of this cycling, which simulates more than 18 years of device operation. No failures were observed.

Operating Life Test

A 550 hour long term series of tests were carried out at room temperature. Regular CO injections into the test chamber allowed determination of the CO sensor response against time.

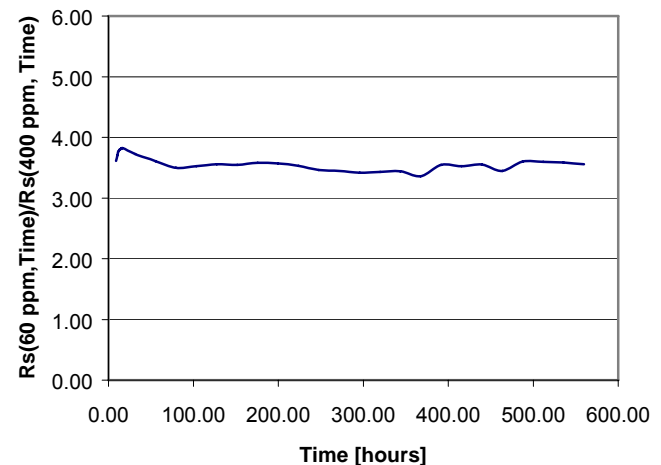

e2v semiconductor gas sensors are well suited for leak detection and applications requiring limited accuracy. Their use for absolute gas concentration detection is more complicated because they typically require temperature compensation, calibration, and sometimes as well, humidity compensation. Their base resistance in clean air and their sensitivity can vary overtime depending on the environment they are in. This effect must be taken into account for any application development. (1103 1.0).