

SFO-W Spot-Welded Strain Sensor

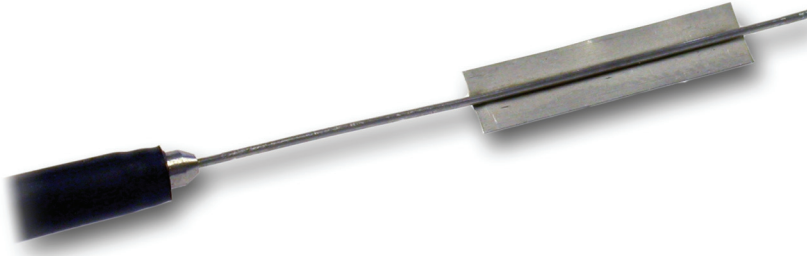

The SFO-W is a fiber optic, spot-welded strain sensor designed for civil engineering applications such as the monitoring of dams, bridges, tunnels, and other structures.

The SFO-W strain sensor offers small size, high accuracy, immunity to EMI/RFI, and resistance to corrosive environments with a high temperature range.

Manufacturers, civil structure designers, and research engineers may now improve structure technology by monitoring the performance of civil structures. Monitoring specific properties over time will help improve the safety and durability of these structures. The deployment of SFO-W strain sensors within a structure, provides accurate information on changes in strains in structural members of buildings, bridges, tunnel linings and supports during and after construction. The use of the SFO-W strain sensor allows a complete stress/strain analysis in the most challenging environments.

The SFO-W consists of a small diameter stainless steel tube welded on a steel sheet, suitable for spot-welding on steel surfaces.

The sensor is based on a unique fiber optic strain sensor which constitutes a breakthrough in fiber optic sensing. The extrinsic Fabry-Perot strain sensor is bonded inside the steel tube, thereby following the tensile or compressive movements of the spot-welded sensor.

FISO's patented fiber optic technology allows installation of the SFO-W strain sensor at distances as far as 5 kilometers away from the signal conditioner, which makes this optical sensor the perfect candidate for civil structure monitoring.

The SFO-W sensor is designed to be installed easily, without the assistance of a skilled welder. The SFO-W sensor is intended for long-term, precise strain measurements on a variety of structures. It can be installed on flat or cylindrical surfaces.

The SFO-W has a sensitivity and resolution of 0.01% on its full scale and is available with a range of up to 2000 micro-strains.

Key Features

- Immune to EMI/RFI/lightning
- Intrinsically safe
- Static/dynamic response
- High sensitivity and resolution: 0.01% full scale
- Signal transmitted over long distances
- No interference due to fiber bending
- Absolute measurements in engineering units
- Data-acquisition compatible

Applications

- Steel structures
- Dams
- Nuclear power plants
- Structural members of buildings and bridges
- Tunnel supports
- Corrosive environments
- High EMI/RFI environments

Specifications

Strain range	$\pm 1000 \mu\epsilon$, $\pm 1500 \mu\epsilon$, $\pm 2000 \mu\epsilon$
Resolution¹	0.01% of full scale
Transverse sensitivity	<0.1% of full scale
Connector type	ST connector
Operating temperature	-55°C to 85°C (-67°F to 185°F)

1. Signal conditioner dependent.

SFO-W Dimensions

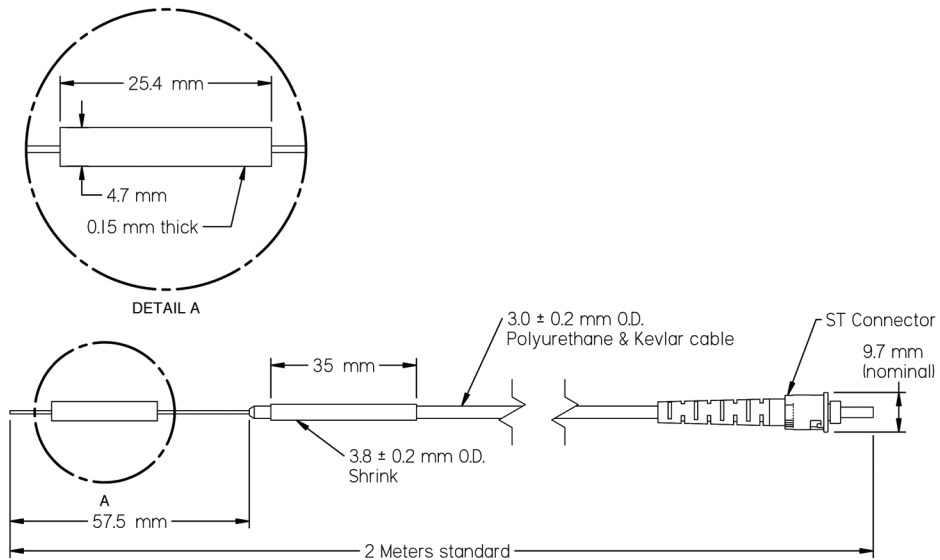

Drawing Number: SCH-00507