

DSM501
DUST SENSOR MODULE

TO :

DUST SENSOR MODULE

P/N : DSM501

SPECIFICATIONS

DSM501
DUST SENSOR MODULE

1. Scope of application

Dust Sensor Module: DSM501 series detects the level of indoor airborne dust, particles, and pollen, and ideal for use in stand-alone air cleaner or IAQ monitor. PWM output of the sensor can be directly connected to μ -com to control fan speed or ventilation and also to display the level of particles. Detectable size of particle is limited to minimum 0.7 μm , and the application for smoke or fire alarm is prohibited.

2. Type

2-1. DSM501A : 2mm pitch connector type (20010WR-05).

2-2. DSM501B : 2.5mm pitch connector type (S5B-EH).

3. Configuration

The configuration of the dust sensor module

Fig. -1. Dimension (mm)

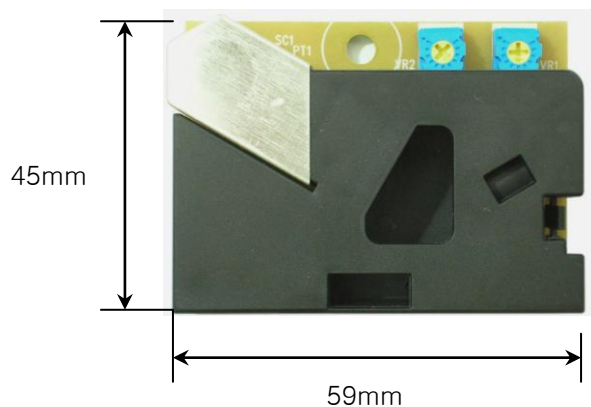

4. Electrical characteristics

- | | |
|--|--|
| 4 - 1. Supply voltage | : DC5V±10% |
| 4 - 2. Power consumption | : 90mA |
| 4 - 3. Operating temperature range | : -10~ +65 °C |
| 4 - 4. Operating humidity range | : 95%RH or less (without dew condensation) |
| 4 - 5. Recommend storage condition | : -20~ +80 °C |
| 4 - 6. Dimension | : W59 * H45 * D20 (mm) |
| 4 - 7. Detectable particle size | : approx. 1 μ m (minimum) |
| 4 - 8. Detectable range of concentration | : 0 ~ 1.4mg/m ³ |
| 4 - 9. Output signal | : PWM (pulse width modulation) |
| 4 - 10. Time for stabilization | : 1 minute after power turned on |
| 4 - 11. Sensor characteristics | : To be maintained in between the upper limit and lower limit of the standard dust sensor unit |

Fig. -2. Sensor Characteristics vs Low ratio

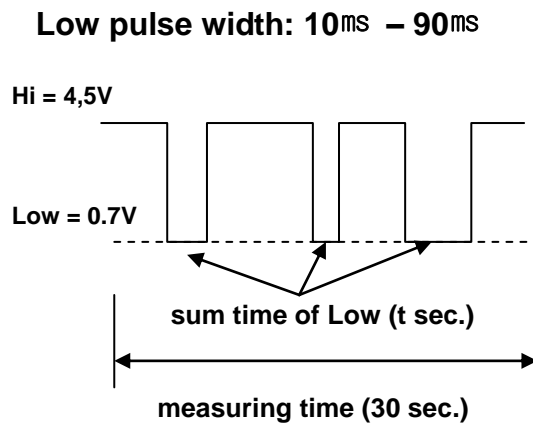
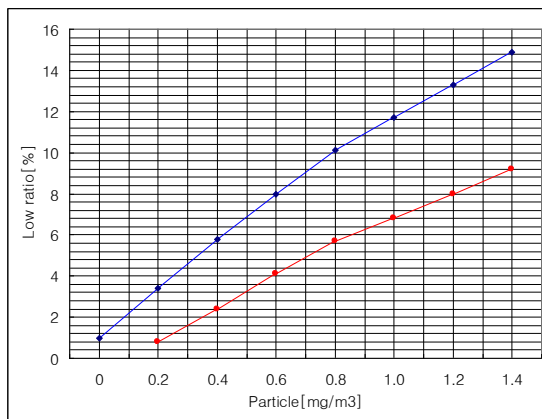

$$\text{Low ratio}[\%] = t(\text{sec}) / 30(\text{sec}) * 100$$

5. Device overview

The dust sensor module DSM501 is a compact sized particle density sensor.

- * Quantitative particle density measurement with the principle of particle counter.
- * Fine particles of bigger than one micron could be detected with high sensitivity.
- * Inside heater induces air inflow to the module.
- * One control contact and two output contacts

A block diagram is illustrated in 5.1.

The DSM501 consists of :

- * Light Emitting Diode (LED) Lamp
- * Detector
- * Signal amplifier circuit
- * Output drive circuit 1
- * Output drive circuit 2
- * Heater induced air flow

5-1. BLOCK DIAGRAM

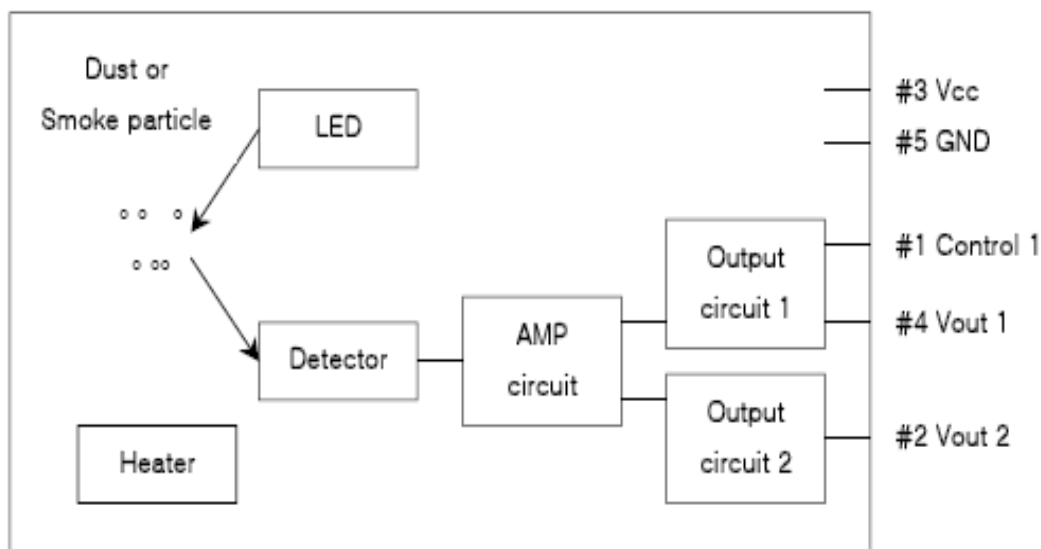

DSM501
DUST SENSOR MODULE

5-2. PINOUT I/O DESCRIPTION

Pin number	Pin name	Description
#1	Control	Vout 1 control
#2	Vout 2	Vout 2 output (PWM)
#3	Vcc	Positive power supply
#4	Vout 1	Vout 1 output (PWM)
#5	GND	Ground

5-3. PIN ARRAY (component view)

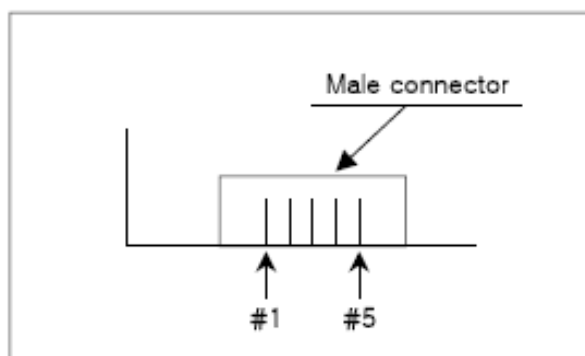

5-4. CONNECTOR PART NUMBER

Model name	Part No.		Description	Connector's maker
DSM501A	Male	20010WR-05	2mm pitch	Yeonho Electronc
	Female	20010HS-05		
DSM501B	Male	S 5B-EH	2.5mm pitch	J.S.T.
	Female	EHR-5		

6. CIRCUIT DESCRIPTION

This section gives a circuit description of the external connections and components of the DSM501, and can be used as a starting point for designs.

6-1. Control (Pin #1)

This pin is used for tuning the sensitivity when Vout1 is used.

6-2. Vout 2 (Pin #2)

The Vout 2 is Standard Output Port.

The sensitivity of Vout 2 pin is preset at factory.

This port gives PWM output for density of particles over 1 μm .

6-3. Vcc (Pin #3)

Positive power (DC 5V) supply

6-4. Vout 1 (Pin #4)

Use this pin when adjustment of detecting level of the minimum particle size is desired.

The sensitivity of Vout 1 is duller than that of Vout 2 about 2.5times.

(Vout1's sensitivity x 2.5times = Vout2's sensitivity).

Adding a resistor between Control (pin #1) and Ground (pin #5), the minimum size of the particles can be adjusted from 1 μm to 2.5 μm .

The standard (open) minimum size of particles is 2.5 μm . (refer to [Table 6.1](#))

Vout1 (Pin #4) gives PWM output.

6-5. Ground (Pin #5)

This pin is used for Ground.

TABLE 6.1. RESISTOR VALUE

Resistor value	Description
open	Preset sensitivity (over 2.5 μm)
47K	Half sensitivity (over 1.75 μm)
18.2K	Equal sensitivity of Vout 2 (over 1 μm)

DSM501
DUST SENSOR MODULE

7. Application

This section provides general information on application for the DSM501.

7-1. Heater

This module has a heater (resistor) to generate heat. Heat creates updraft (upward current of air) which draws outside air into the module.

7-2. Detectable Particles

This module is designed to detect the particle of the size bigger than one micrometer, which usually includes cigarette smoke, house dust, tick, spore, pollen and mildew.

7-3. Installation

The dust sensor module DSM501 should be installed vertically and kept away from any artificial current of air by fans. In case it is used for air purifier of which fan located in front or rear part, it should be installed at either side of the housing, but not too much deep inside of the housing. There also need to have slits near the module so that air can come inside.

In addition, please pay attention to structure and placing location of the application to avoid any adhesive particles (such as oil, etc) getting into the module, which may cause malfunction by sticking to the optical part.

Moisture presence inside of the module may cause malfunction of the sensor. Please avoid the location where condensation may frequently occur.

7-4. Lens

Lens is coated with anti static and anti dust polymer. But for better performance, it needs to be cleaned depending on the condition. Cleaning every six months for office environment and every three months for industrial environment is recommended. When cleaning, wet one side of swab with water and rub the lens with it and then dry lens with the other end of swab.

DSM501
DUST SENSOR MODULE

8. Output Characteristics

Vcc=5V, Ta=25°C

Parameter	Symbol	Condition	Min.	Typ.	Max.	Unit
Vout 1, 2 at high ^{*1}	Voh	No particle	4.0	4.3	-	V
Vout 1, 2 at low ^{*2}	Vol	Particle	-	0.7	1.0	V
Supply current	Icc		-	-	90	mA
Time for stabilization ^{*3}			1	-	minute	

*1 : Vout 1 and Vout 2 are high state when particles are not detected. (=clean room)

*2 : Vout 1 and 2 go to low state when particles are detected.

*3 : After the power is turned on.

8-1. VOLTAGE vs. CURRENT

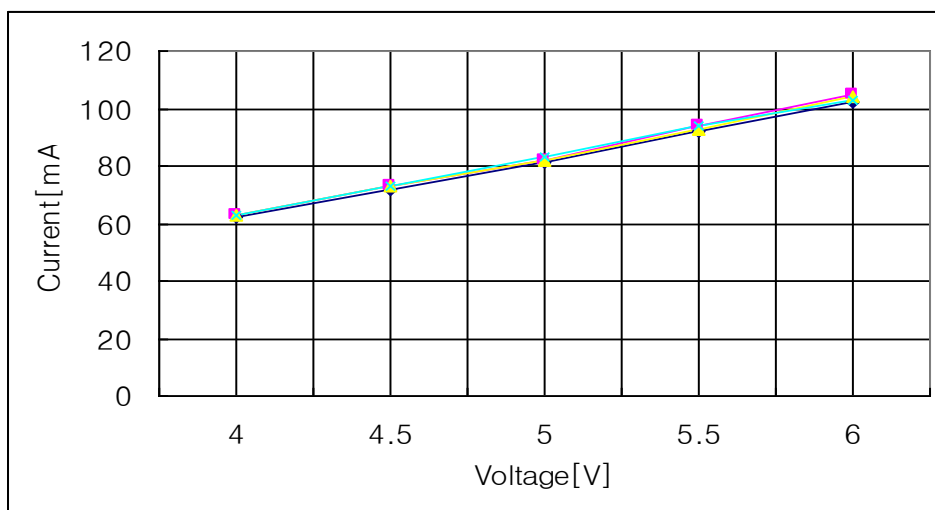

DSM501
DUST SENSOR MODULE

8-2. LOW RATIO vs. CONCENTRATION

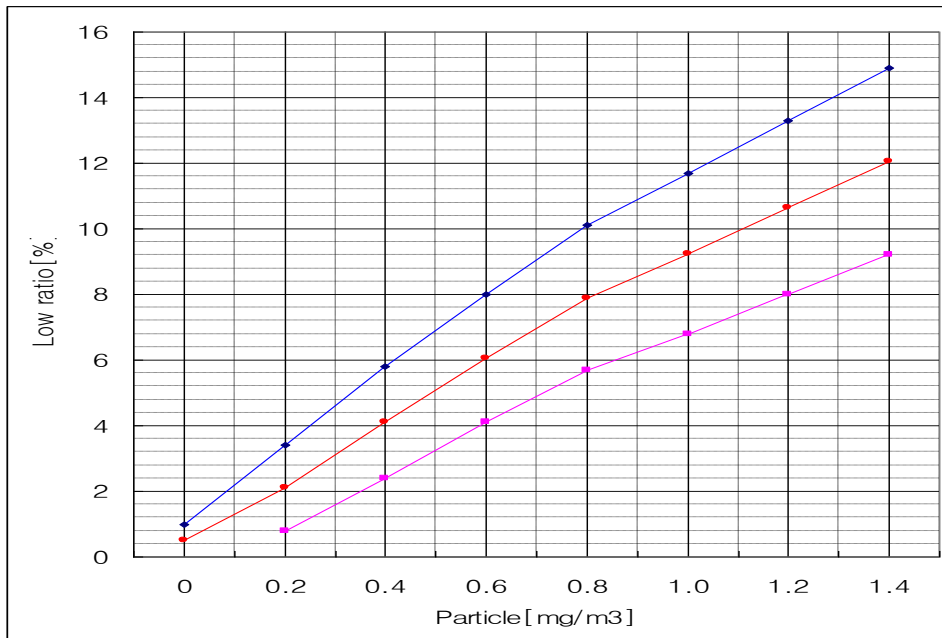

8-3. LOW RATIO vs. PARTICLE

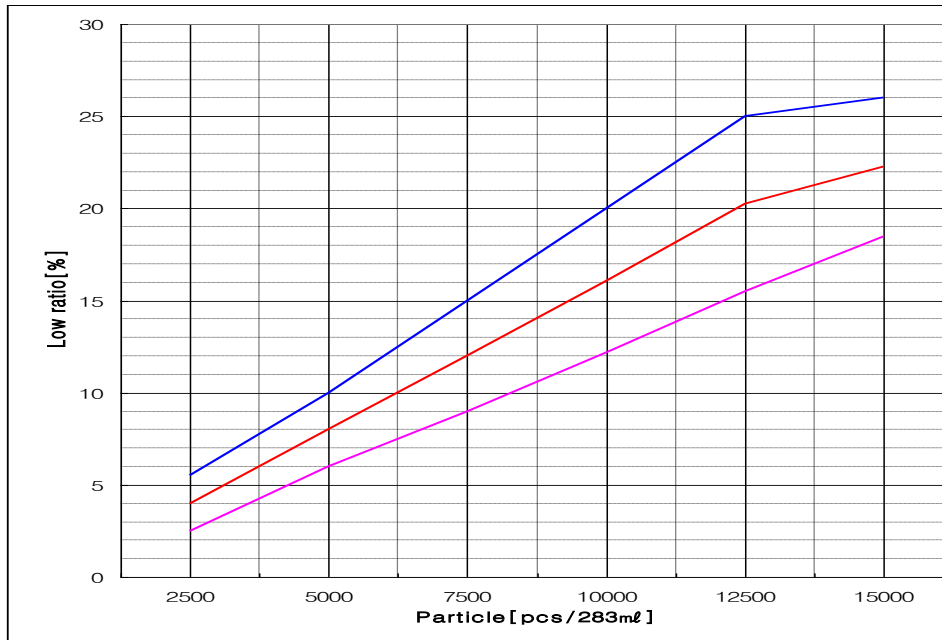

* X-axis shows number of particles and Y-axis shows output characteristics. Upper curve shows upper limit output characteristics and lower one shows lower limit.

DSM501
DUST SENSOR MODULE

9. Packaging information

9-1. Package Marking Information

Model no.	DSM501A or DSM501B
Qt'y	000 pcs

9-2. Package Details

Module dimensions	: W59 x H45 x D20 mm
Weight	: Approx. 25g ea
Tray	: modules of 25pcs.(5x5) per tray
Inner box	: 5 trays per box (module 125pcs)
Outer box	: 4 inner boxes per one outer box (module 500pcs)
Outer Box Dimensions	: W670 x H250 x D420mm
Weight	: Max. 13Kg per outer box

10. Product Identification System

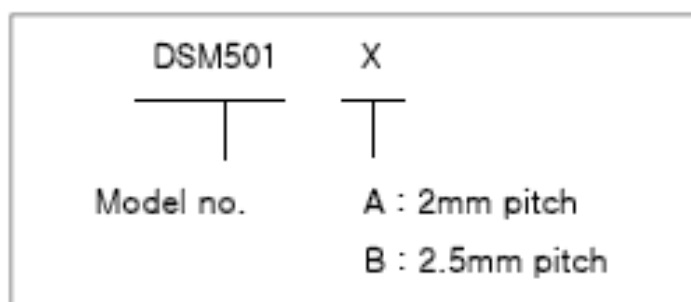

DSM501
DUST SENSOR MODULE

■ **Caution for Use**

VR trimmer for sensitivity adjustment is set up at shipping from Samyoung S&C.

Please do not touch the VR trimmer.

Please do not disassemble the device. If the device is reassembled, it may not satisfy the specification.

If the device is used in heavily smoked or dusted environment, more frequent cleaning of the lens and maintenance such as vacuuming or air blowing is recommended.

Please **NEVER use this device for Emergency or Fire Alarm application.**

This publication is the proprietary product of Samyoung S&C and is copyrighted, with all rights reserved. Under the copyright laws, no part of this publication may be reproduced or transmitted in any form or by any means, electronic or mechanical, for any purpose, in whole or in part, without the express written permission of Samyoung S&C. Express written permission is also required before a third party may make any use of this publication.