



ANWENDUNGEN

- ◆ Schiffbau
 ABS, BV, DNV, GL, KRS, LRS, RINA
- ◆ Motorenbau
- ◆ Schienenfahrzeuge
- ◆ Maschinenbau
- ◆ Hydraulik
 - ◇ HLK
 - ◇ Kältetechnik
 - ◇ Prozess Techn.
 - ◇ Wasseraufbereitung
 - ◇ Autoindustrie
 - ◇ Prüfstände
 - ◇ Ex
 - ◇ Lebensmittelindustrie
 - ◇ Autoklaven

APPLICATIONS

- ◆ Construction navale
 ABS, BV, DNV, GL, KRS, LRS, RINA
- ◆ Constr. de moteurs
- ◆ Véhicules sur rail
- ◆ Machines-outils
- ◆ Hydraulique
 - ◇ CVC
 - ◇ Réfrigération
 - ◇ Techn. de procédés
 - ◇ Traitement de l'eau
 - ◇ Industrie automobile
 - ◇ Banc d'essai à frein
 - ◇ Ex
 - ◇ Industrie alimentaire
 - ◇ Autoclavage

APPLICATIONS

- ◆ Shipbuilding
 ABS, BV, DNV, GL, KRS, LRS, RINA
- ◆ Engine manufacturing
- ◆ Railways
- ◆ Machine tools
- ◆ Hydraulics
 - ◇ HVAC
 - ◇ Refrigeration
 - ◇ Process technology
 - ◇ Water treatment
 - ◇ Automotive industry
 - ◇ Test benches
 - ◇ Ex
 - ◇ Food Industry
 - ◇ Autoclaves



HAUPTMERKMALE

- ◆ Fühler: Balg
- ◆ Messbereich: -0.9...1.5 bis 10...100 bar
- ◆ Ausgang: potentialfreier Umschaltkontakt
- ◆ Schaltdifferenz: nicht einstellbar
- ◆ Reproduzierbarkeit: ± 1.0 % d.S. typ.
- ◆ Skalengenauigkeit: ± 2.0 % d.S. typ.
- ◆ EN60730-1/ EN60730-2-6: Typ 2.B.H

CARACTÈRES DISTINCTIFS

- ◆ Capteur: soufflet
- ◆ Plage de mesure: -0.9...1.5 à 10...100 bar
- ◆ Sortie: inverseur libre de potentiel
- ◆ Différentiel de l'interrupteur: non ajustable
- ◆ Reproductibilité: ± 1.0 % E.M. typ.
- ◆ Précision de l'échelle: ± 2.0 % E.M. typ.
- ◆ EN60730-1/ EN60730-2-6: Typ 2.B.H

MAIN CHARACTERISTICS

- ◆ Sensor: bellows
- ◆ Measuring range: -0.9...1.5 to 10...100 bar
- ◆ Output: floating change-over contact
- ◆ Switching differential: not adjustable
- ◆ Repeatability: ± 1.0 % FS typ.
- ◆ Scale accuracy: ± 2.0 % FS typ.
- ◆ EN60730-1/ EN60730-2-6: Typ 2.B.H

VORTEILE

- ◆ Robustes Alu-Gehäuse
- ◆ Schutzart IP 65
- ◆ Beliebige Einbaulage

AVANTAGES PRINCIPAUX

- ◆ Boîtier robuste en aluminium
- ◆ Protection IP 65
- ◆ Montage toutes positions

MAIN FEATURES



- ◆ Rugged aluminium housing
- ◆ Protection IP 65
- ◆ Any mounting position possible

BESTELLINFORMATION / INFORMATION POUR LA COMMANDE / ORDERING INFORMATION

Lager Code (kurze Lieferzeit)/ Codification stock (délai de livraison bref)/ Code for stock products (short delivery time): **P/PS** (z.B./ Ex./e.g: P16)

☞ siehe Katalog/ voir catalogue/ see catalogue: „Standard Products“

Varianten Code/ Codification de variantes/ Custom build code	XXX	XXXX	XXX	XX	XX	...
Mit Anzeige; mit Verstell-Schraube/ Avec affichage; réglage par vis/ With display; with adjusting screw	900					
Ohne Anzeige; mit Verstell-Schraube/ Sans affichage; réglage par vis/ Without display; with adjusting screw	904					
Mit Anzeige; mit Verstell-Knopf/ Avec affichage; réglage par mollette/ With display; with adjusting knob	912					



Mikroschalter ¹⁾ Kleine Schaltdifferenz/ Interrupteur à petit différentiel/ Small switching differential	10
Microrupteur Mittlere Schaltdifferenz/ Interrupteur à moyen différentiel/ Average switching differential	11
Microswitch  Erhöhte Vibrationsbeständigkeit/ Résistance de vibration élevée/ Improved vibration resistance	23
 Hohe Vibrationsfestigkeit/ Résistance de vibration forte/ High vibration resistance	26
Mit vergoldeten Kontakten/ Avec contacts dorés/ With gold plated contacts	21

¹⁾ Schaltdifferenz/ Différentiel de l'interrupteur/ Switching differential: nicht einstellbar/ non ajustable/ Not adjustable

Bereich -0.9... 1.5	Überdruck 10	Berstdruck 13	72
Plage 0.2... 1.6	Surpression 10	Pression destruction 13	73
Range 0.2... 2.5	Overpressure 10	Burst pressure 13	75
	12	26	76
[bar] 0.0... 4.0	[bar] 12	[bar] 26	77
1.0... 10.0	24	36	78
1.0... 16.0	24	36	79
2.0... 25.0	40	75	80
4.0... 40.0	40	75	81
6.0... 60.0	100	160	82
10.0... 100.0	100	160	83

Fühler Capteur Sensor	Balg: Bronze Gehäuse: Messing Soufflet: bronze Boîtier: laiton Bellows: bronze Housing: brass		Balg: Bronze Gehäuse: Messing chem. vern. Soufflet: bronze Boîtier: laiton chim. nickelé Bellows: bronze Hous.: brass chem. nickel plated		Balg: 1.4435 Medienberührende Teile: 1.4435 Gehäuse: MS vernickelt Soufflet: 1.4435 Matériel contact. avec médias: 1.4435 Boîtier: laiton nickelé Bellows: 1.4435 Medium contact. parts: 1.4435 Housing: brass, nickel plated	
Material/ matière/ material						
Gewinde/ filet/ thread	G1/4" f ²⁾	G1/2" m ³⁾	G1/4" f ²⁾	G1/2" m ³⁾	G1/4" f ²⁾	G1/2" m ³⁾
Bereich	72	900	909	950	959	800
Plage	73, 75	901	902	951	952	801
Range	76, 77	903	904	953	954	803
	78, 79	905	906	955	956	805
	80, 81	907	908	957	958	807
	82, 83	940⁴⁾	941⁴⁾			840
						809
						802
						804
						806
						808
						841

Befestigung Fixation Mounting	Direkt am Fühler oder Gehäuse/ Directement à capteur ou boîtier/ Direct on sensor or housing Mit Montagebügel/ Avec platine murale/ By mounting bracket	00 31
--	--	------------------------

Zubehör Accessoires Accessories	Plombierung (Schutz vor Manipulation)/ Plombage (protection contre manipulations/ Lead seal (manipulation protection)	16
	Kabelverschraubung/ Passe-câble à vis/ Screwed cable gland  M20x1.5 (EN 50262)	07
	Kabelverschraubung/ Passe-câble à vis/ Screwed cable gland  M24x1.5 (DIN89280)	27
	Kabelverschraubung/ Passe-câble à vis/ Screwed cable gland  M18x1.5 (DIN89280)	40
	Ohne Kabelverschraubung/ Sans passe-câble à vis/ Without screwed cable gland	33
	Bahnsichere Ausführung/ Exécution pour ferroviaire/ Railway-safety execution	28

Dämpfungselemente und Snubber/ Eléments d'amortissement et Snubber/ Damping elements and Snubber:

siehe Datenblatt/ voir spécification /see specification sheet H72258



Trafag entwickelt und produziert auch speziell auf Ihre Bedürfnisse zugeschnittene Produkte. Bitte fragen Sie uns an.
Trafag développe et fabrique des produits adaptés à vos besoins spécifiques en se basant sur votre cahier des charges. Contactez-nous s.v.p.
Trafag develops and manufactures customer-engineered products according to your specifications to meet your requirements. Please contact us.

SPEZIFIKATIONEN

HAUPTMERKMALE

Fühler: Balg
Messbereich: -0.9...1.5 bis 10...100 bar
Ausgang: potentialfreier Umschaltkontakt
Schaltdifferenz: nicht einstellbar
EN60730-1/ EN60730-2-6: Typ 2.B.H

GENAUIGKEIT (@ 20°C)

Reproduzierbarkeit Fühler: ± 1.0 % d.S. typ.
Skalengenauigkeit: ± 2.0 % d.S. typ.
Schaltdifferenz: siehe Tabelle

MIKROSCHALTER

Schaltleistung: siehe Tabelle
Isolationswiderstand: > 2 MΩ
Spannungsfestigkeit: 1.25 kV gegenüber Masse
Lebensdauer (mechanisch)
Mikroschalter 10/11: 20 Mio. Lastspiele
Mikroschalter 21: 0.5 Mio. Lastspiele
Mikroschalter 23/26: 0.3 Mio. Lastspiele

ELEKTRISCHER ANSCHLUSS

Kabelverschraubung: M20x1.5
Kabel-Ø 6...13 mm
Schraubenklemmen: 3 x 1.5...4 mm²

UMGEBUNGSBEDINGUNGEN

Betriebstemperatur: -25...+70°C
Medientemperatur: -40...+150°C
Lagertemperatur: -25...+85°C
Schutzart: IP65
Feuchtigkeit: max. 95 % relativ
Vibration:
5...25 Hz: ±1.6 mm
25...100 Hz: 4g
Bereiche 72, 73, 75
5...50 Hz: 20 mm/Sek.
Schock: 50g/ 11ms

MECHANISCHE DATEN

Material
Fühler: siehe Bestellinformation
Gehäuse: AlSi10Mg/ Epoxy beschichtet
Dichtung: NBR
Kabelverschraubung: Messing vernickelt
Anziehdrehmoment: max. 25 Nm
Einbaulage: beliebig
Gewicht: ~ 710 g

SPECIFICATIONS

CARACTÈRES DISTINCTIFS

Capteur: soufflet
Plage de mesure: -0.9...1.5 à 10...100 bar
Sortie: inverseur libre de potentiel
Différentiel de l'interrupteur: non ajustable
EN60730-1/ EN60730-2-6: Typ 2.B.H

PRÉCISION (@ 20°C)

Reproductibilité capteur: ± 1.0 % E.M. typ.
Précision de l'échelle: ± 2.0 % E.M. typ.
Différentiel de l'interrupteur: voir tableau

MICRORUPTEUR

Pouvoir de coupe: voir tableau
Résistive d'isolation: > 2 MΩ
Rigidité diélectrique: 1.25 kV contre la masse
Durée de vie (mécanique)
Microrupteur 10/11: 20 Mio. cycles
Microrupteur 21: 0.5 Mio. cycles
Microrupteur 23/26: 0.3 Mio. cycles

CONNECTION ÉLECTRIQUE

Passe-câble à vis: M20x1.5
Câble-Ø 6...13 mm
Borne à vis: 3 x 1.5...4 mm²

CONDITIONS D'ENVIRONNEMENT

Température de service: -25...+70°C
Température de médias: -40...+150°C
Temp. de stockage: -25...+85°C
Protection: IP65
Humidité: max. 95 % relatif
Vibration:
5...25 Hz: ±1.6 mm
25...100 Hz: 4g
Plages 72, 73, 75
5...50 Hz: 20 mm/sec.
Choc: 50g/ 11 ms

SPECIFICATIONS MÉCANIQUES

Matériau
Capteur: voir information pour la commande
Boîtier: AlSi10Mg/ Vernis avec époxy
Joint: NBR
Passe-câble à vis: laiton nickelé
Couple de serrage: max. 25 Nm
Montage: toute position
Poids: ~ 710 g

SPECIFICATIONS

MAIN CHARACTERISTICS

Sensor: bellow
Measuring range: -0.9...1.5 to 10...100 bar
Output: floating change-over contact
Switching differential: not adjustable
EN60730-1/ EN60730-2-6: Typ 2.B.H

ACCURACY (@ 20°C)

Repeatability sensor: ± 1.0 % FS typ.
Scale accuracy: ± 2.0 % FS typ.
Switching differential: see table

MICROSWITCH

Rating: see table
Resistance of insulation: > 2 MΩ
Dielectric strength: 1.25 kV terminal ground
Life time (mechanical)
Microswitch 10/11: 20 Mio. cycles
Microswitch 21: 0.5 Mio. cycles
Microswitch 23/26: 0.3 Mio. cycles

ELECTRICAL CONNECTION

Screwed cable gland: M20x1.5
Cable-Ø 6...13 mm
Terminal screw: 3 x 1.5...4 mm²

ENVIRONMENTAL CONDITIONS

Operating temperature: -25...+70°C
Media temperature: -40...+150°C
Storage temperature: -25...+85°C
Protection: IP65
Humidity: max.95 % relative
Vibration:
5...25 Hz: ±1.6 mm
25...100 Hz: 4g
Ranges 72, 73, 75
5...50 Hz: 20 mm/sec.
Shock: 50g/ 11 ms

MECHANICAL DATA



Material
Sensor: see ordering information
Housing: AlSi10Mg/ Epoxy coated
Seal: NBR
Screwed cable gland: brass nickel plated
Mounting torque: max. 25 Nm
Installation: any position
Weight: ~ 710 g

SCHALTDIFFERENZ (typ.) / DIFFÉRENTIEL DE L'INTERRUPTEUR (typ.) / SWITCHING DIFFERENTIAL (typ.)

Balgfühler Capteur soufflet Bellows sensor	Bereich/ Plage/ Range [bar]					
	-0.9...1.5 0.2...1.6 0.2...2.5	0...4 0...6	1...10 1...16	2...25 4...40	6...60 10...100	
Mikroschalter/ Microrupteur/ Microswitch	10	0.03	0.08	0.2	0.5	1.5
	11/21/23	0.1	0.2	0.4	1.0	3.0
	26	0.1	0.3	0.8	2.0	5.0
P max.	10	12	24	40	100	

Schaltdifferenz [bar]: fester Wert, nicht einstellbar
 Différentiel de l'interrupteur [bar]: valeur fixe, non ajustable
 Switching differential [bar]: fixed value, not adjustable

ELEKTRISCHE DATEN SCHALTER / SPÉCIFICATIONS ÉLECTRIQUES DE L'INTERRUPTEUR / ELECTRICAL DATA SWITCH

Typ Type Type	Merkmale Caractéristiques Features	Schaltleistung ⁵⁾ Pouvoir de coupure Rating	
		AC	DC
10	Kleine Schaltdifferenz Interrupteur à petit différentiel Small switching differential	125 V 10 (1.5) A 250 V 10 (1.25) A	250 V 0.2 (0.02) A 125 V 0.4 (0.03) A 30 V 2 (1) A 14 V 15 (2.5) A
11	Mittlere Schaltdifferenz Interrupteur à moyen différentiel Average switching differential	125 V 15 (1.5) A 250 V 15 (1.25) A 500 V 10 (0.75) A	250 V 0.25(0.03) A 125 V 0.5(0.05) A 30 V 6 (1.5) A 14 V 15 (2.5) A
23 	Erhöhte Vibrationsfestigkeit; mittlere Schaltdifferenz Résistance de vibration élevée; interrupteur à moyen différentiel Improved vibration resistance; average switching differential	125 V 15 (1.5) A 250 V 15 (1.25) A 500 V 10 (0.75) A	250 V 0.3(0.05) A 125 V 0.75(0.1) A 30 V 15 (1.5) A 14 V 15 (1.5) A
26 	Hohe Vibrationsfestigkeit; mittlere Schaltdifferenz Résistance de vibration forte; interrupteur à moyen différentiel High vibration resistance; average switching differential	125 V 15 (1.5) A 250 V 15 (1.25) A 500 V 10 (0.75) A	250 V 0.3(0.2) A 125 V 0.75(0.4) A 30 V 15 (1.5) A 14 V 15 (1.5) A
21	Mit Goldkontakten, geeignet für eigensichere Schaltkreise Avec contacts dorés, approprié aux circuits de contrôle à sécurité intrinsèque Gold plated contacts, suitable for intrinsically safe control circuits	24 V 0.01(0.01)A 12 V 1 (1.0) A 5 V 2 (2.0) A	24 V 0.01(0.01)A 12 V 1.0 (1.0) A 5 V 2.0 (2.0) A

⁵⁾ Ohmsche Last (Induktive Last)
 Charge ohmique (Charge inductive)
 Resistive Load (Inductive Load)

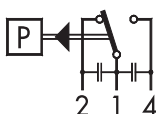

Schalter/ Interrupteur/ Switch **10/11/23**

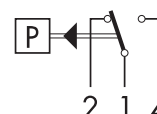

Schalter/ Interrupteur/ Switch **21/26**

MASSBILDER / COTES D'ENCOMBREMENT / DIMENSIONS

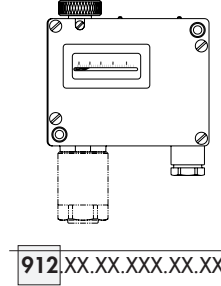
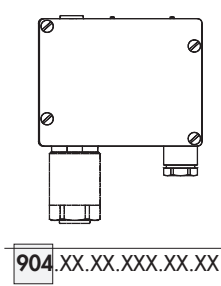
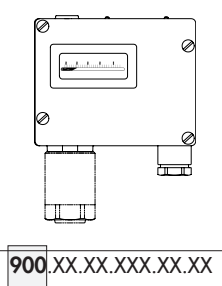
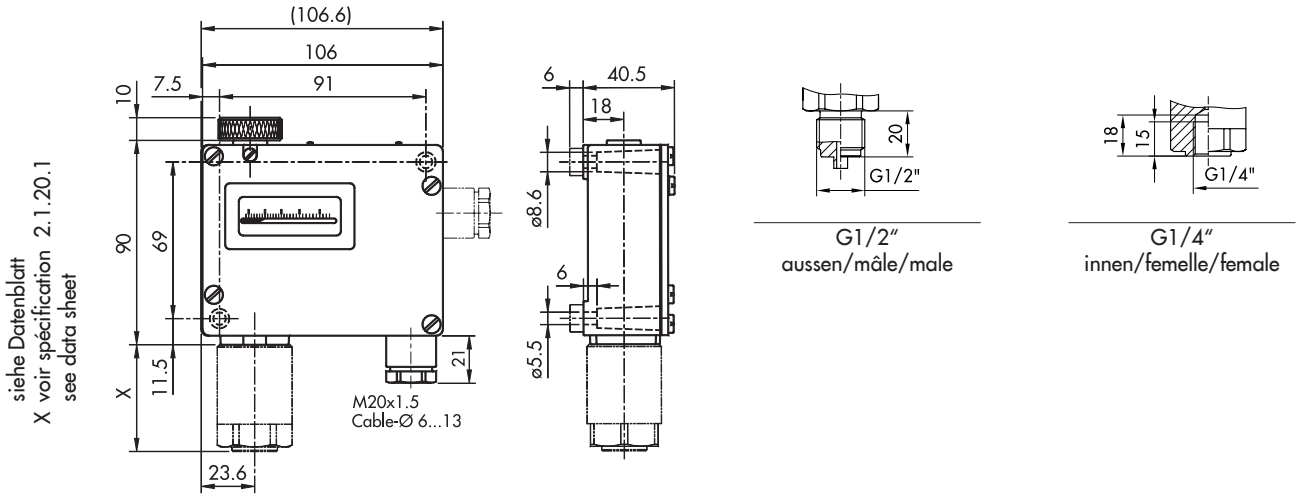

BEFESTIGUNG / FIXATION / MOUNTING

ZUBEHÖR / ACCESSOIRES / ACCESSORIES

