

NAIS

COMPACT FLAT POWER RELAY FOR HEATER LOADS

JV-N RELAYS

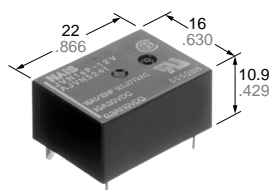

FEATURES

- **High 16 A capacity**

The contacts are high capacity 16A, 125 V AC.

- **Compact, flat type with low 10.9 mm .429 inch height**

Compact flat type with low surface area of 16 × 22 mm .630 × .866 inch and height of 10.9 mm .429 inch.

- **High sensitivity at 200 mW**

High sensitivity at 200 mW coil power consumption.

- **Represses contact terminal heat**

The contact terminals are larger and thicker compared to the existing JV relay. This limits the rise in temperature of the terminals when there is a large current flowing to approx. 28°C 62°F (normal current of 16 A).

- **Conforms to the various safety standards**

UL/CSA, TÜV approved.

SPECIFICATIONS

Contact

Arrangement	1 Form A	
Initial contact resistance, max. (By voltage drop 6 V DC 1 A)	Max. 30 mΩ	
Contact material	Silver alloy	
Rating (resistive load)	Nominal switching capacity	16 A 125 V AC, 10 A 277 V AC 10 A 30 V DC, 10 A 125 V AC
	Max. switching power	2,770 VA, 300 W
	Max. switching voltage	277 V AC, 30 V DC
	Max. switching current	16 A (AC 125 V), 10 A (DC)
Expected life (min. ope.) Mechanical (at 180 cpm)	2×10 ⁷	
Electrical at resistive load (at 20 cpm)	Sealed type 16 A 125 V AC, 10 A 30 V DC	10 ⁵
	Flux-resistant type 10 A 125 V AC	3×10 ⁵

Coil

Nominal operating power	200 mW (DC 4.5 to 48 V) 600 mW (DC 100 V)
-------------------------	--

Remarks

* Specifications will vary with foreign standards certification ratings.

*¹ Excluding contact bounce time

*² Excluding contact bounce time, without diode

*³ By resistive method; nominal voltage applied to the coil; contact carrying current: 16A, at 70°C 158°F

*⁴ Nominal voltage applied to the coil, at 60°C 140°F

*⁵ Half-wave pulse of sine wave: 11 ms; detection time: 10 μs

*⁶ Half-wave pulse of sine wave: 6 ms

*⁷ Detection time: 10 μs

*⁸ Refer to 5. Conditions for operation, transport and storage mentioned in AMBIENT ENVIRONMENT (Page 61).

Characteristics

Max. operating speed	20 cpm	
Operate time* ¹ (at nominal voltage)	Max. 12 ms (DC 4.5 V to 48 V) Max. 8 ms (DC 100 V)	
Release time* ² (at nominal voltage)	Max. 5 ms	
Initial insulation resistance	Min. 1,000 MΩ (at 500 V DC)	
Initial breakdown voltage (Detection current: 10 mA)	Between open contacts	1,000 Vrms for 1 min.
	Between contacts and coil	2,500 Vrms for 1 min.
Surge voltage between contact and coil	Min. 4,500 V	
Temperature rise	Max. 45°C (DC 4.5 V to 48 V) * ³ Max. 55°C (DC 100 V) * ⁴	
Conditions in case of operation, transport and storage* ⁸	Ambient temperature -40 to 70°C -40 to 158°F (DC 4.5 to 48 V) -40 to 60°C -40 to 140°F (DC 100V) Humidity: 5 to 85 % R.H. (Note freezing and condensing at low temperature) Air pressure: 86 to 106 kPa	
Shock resistance	Functional	Min. 200 m/s ² {20G}* ⁵
	Destructive	Min. 1,000 m/s ² {100G}* ⁶
Vibration resistance	Functional	10 to 55 Hz * ⁷ at double amplitude of 1.6 mm
	Destructive	10 to 55 Hz at double amplitude of 2 mm
Unit weight	Approx. 8g .28 oz	

TYPICAL APPLICATIONS

- AV equipment: TV's, VTR's, etc.
- OA equipment
- HA equipment

ORDERING INFORMATIONS

Ex. JVN 1a F - 4.5 V

Contact arrangement	Protective construction	Coil voltage (DC)
1a: 1 Form A	Nil: Sealed type F: Flux-resistant type	4.5, 6, 9, 12, 18, 24, 48, 100 V

UL/CSA, TÜV approved type is standard.

JV-N

TYPES AND COIL DATA (at 20°C 68°F)

Part No.		Nominal voltage, V DC	Pick-up voltage V DC (max.)	Drop-out voltage V DC (min.)	Coil resistance, W (±10%)	Nominal operating current, mA (±10%)	Nominal operating power, mW	Max. allowable voltage, V DC
Sealed type	Flux-resistant type							
JVN1a-4.5V	JVN1aF-4.5V	4.5	3.375	0.23	101	44.4	200	6.75
JVN1a-6V	JVN1aF-6V	6	4.5	0.3	180	33.3	200	9
JVN1a-9V	JVN1aF-9V	9	6.75	0.45	405	22.2	200	13.5
JVN1a-12V	JVN1aF-12V	12	9	0.6	720	16.7	200	18
JVN1a-18V	JVN1aF-18V	18	13.5	0.9	1,620	11.1	200	27
JVN1a-24V	JVN1aF-24V	24	18	1.2	2,880	8.3	200	36
JVN1a-48V	JVN1aF-48V	48	36	2.4	11,520	4.2	200	72
JVN1a-100V	JVN1aF-100V	100	60	4	16,600	6	600	110

DIMENSIONS

mm inch

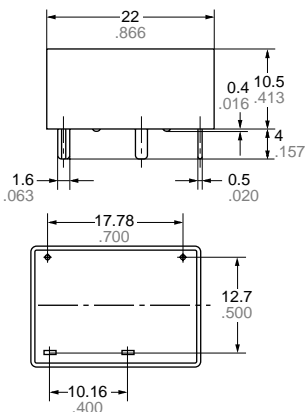

Dimension:

Max. 1mm .039 inch:
 1 to 5mm .039 to .197 inch:
 Min. 5mm .197 inch:

General tolerance

±0.2 ±.008
 ±0.3 ±.012
 ±0.4 ±.016

PC board pattern

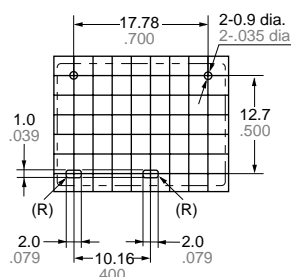

REFERENCE DATA

1. Max. switching power

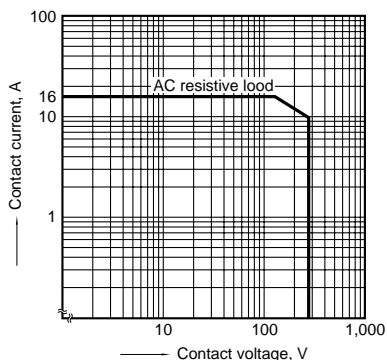

2. Operate/release time

Sample: JVN1aF-12 V, 6 pcs.

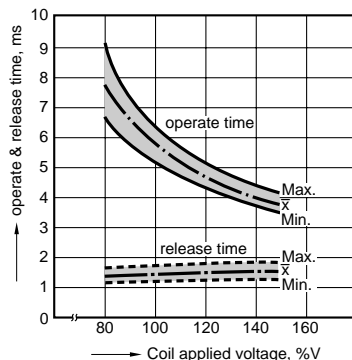

3. Coil temperature rise

Sample: JVN1aF-12 V, 6 pcs. point measured: coil inside
 Contact current: 16 A

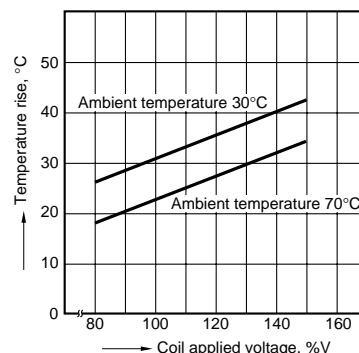

4. Ambient temperature characteristics

Sample: JVN1aF-12 V, 6 pcs.

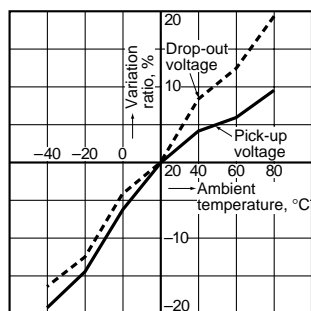

5. Life curve

Operation frequency: 20 times/min.
 Ambient temperature: room temperature

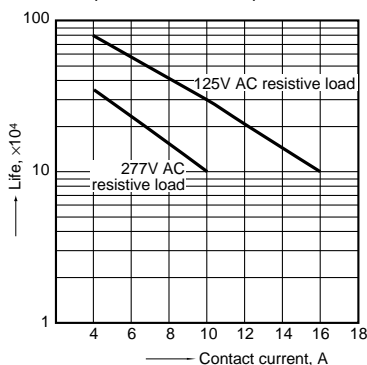

For Cautions for Use, see Relay Technical Information (Page 48 to 76).