

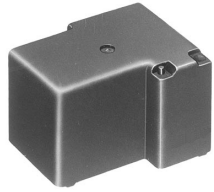

NAIS

COMPACT ECONOMICAL 30 AMP. RELAY

JT-N-JT RELAYS



PCB type



TMP type



Open type

FEATURES

- High switching capacity — 30 A for 1 Form A
- 2 contact arrangements — 1 Form A or 1 Form C
- Sealed and “TMP” types available
- UL/CSA recognized (PCB & TMP type: UL508 group A spacing, UL873 spacing)
- Class F types standard for PCB & TMP type

SPECIFICATIONS

Contacts

		PCB & TMP type		Open type	
Arrangement		1 Form A	1 Form C	1 Form A	1 Form C
Initial contact resistance, max. (By voltage drop method, 6 V DC 1 A)		50 mΩ		20 mΩ	
Contact material		Silver alloy			
Rating	Max. switching power	8310 VA	N.C.: 2770 VA N.O.: 5440 VA	8310 VA 900 W	N.C.: 2770 VA, 300 W N.O.: 5440 VA, 600 W
	Max. switching voltage	277 V AC		277 V AC, 30 V DC	
	Max. switching current	30 A	N.C.: 10 A N.O.: 20 A	30 A	N.C.: 10 A N.O.: 20 A
Expected life		Min. 1×10 ⁷			
Mechanical		20 A 277 V AC	N.O.: 20 A 277 V AC Min. 1×10 ⁵ *	30 A 277 V AC	N.O.: 20 A 277 V AC 20 A 30 V DC Min. 1×10 ⁵
Electrical (Resistive load)		Min. 1×10 ⁵ *	N.C.: 10 A 277 V AC Min. 1×10 ⁵ *	30 A 30 V DC Min. 1×10 ⁵	N.C.: 10 A 277 V AC 10 A 30 V DC Min. 1×10 ⁵

* For sealed types, the life shown is for open venting-hole condition.

Coil at 20°C 68°F

	JT-N	JT
	PCB & TMP type	Open type
Minimum operating power	Approx. 450 mW	Approx. 500 mW
Nominal operating power	Approx. 800 mW	Approx. 900 mW

Characteristics

		PCB & TMP type	Open type
Initial insulation resistance* ¹		Min. 100 MΩ at 500 V DC	
Initial breakdown voltage* ²	Between contacts	1,200 Vrms	1,500 Vrms
	Between contacts and coil	2,500 Vrms	1,500 Vrms
Operate time* ³ (at nominal voltage)		Max. 15 ms	
Release time (without diode)* ³ (at nominal voltage)		Max. 10 ms	
Shock resistance	Functional* ⁴	Min. 98 m/s ² {10 G}	
	Destructive* ⁵	Min. 980 m/s ² {100 G}	
Vibration resistance	Functional* ⁶	Max. 88.2 m/s ² {9 G}, 10 to 55 Hz at double amplitude of 1.5 mm	
	Destructive	Max. 117.6 m/s ² {12 G}, 10 to 55 Hz at double amplitude of 2 mm	
Conditions for operation, transport and storage* ⁷ (Not freezing and condensing at low temperature)	Ambient temp.	-55°C to +85°C -67°F to +185°F	
	Humidity	5 to 85% R.H.	
Unit weight	PCB type:	Approx. 25 g (.88 oz)	Approx. 20 g (.71 oz)
	TMP type:	Approx. 30 g (1.06 oz)	

Remarks

- * Specifications will vary with foreign standards certification ratings.
- *¹ Measurement at same location as “Initial breakdown voltage” section
- *² Detection current: 10 mA
- *³ Excluding contact bounce time
- *⁴ Half-wave pulse of sine wave: 11ms; detection time: 10μs
- *⁵ Half-wave pulse of sine wave: 6ms
- *⁶ Detection time: 10μs
- *⁷ Refer to 5. Conditions for operation, transport and storage mentioned in AMBIENT ENVIRONMENT (Page 61).

TYPICAL APPLICATIONS

- Automotive
- Air conditioner
- Heating & ventilation
- Home appliance

ORDERING INFORMATION

1. JT-N Relays (PCB and TMP type)

JTN — 1a — S — TMP — F — DC12V				
Contact arrangement	Protective construction	Mounting classification	Coil insulation	Coil voltage
1a: 1 Form A 1: 1 Form C	S: Sealed type	PA: PCB type (UL508) TMP: TMP type (UL508)	F: Class F	DC 5, 6, 9, 12, 15, 18, 24 V

2. JT Relays (Open type)

JT — 1a — DC12V	
Contact arrangement	Coil voltage
1a: 1 Form A 1: 1 Form C	DC 5, 6, 9, 12, 15, 18, 24 V

UL/CSA approved type is standard.

Note: DC rating is available for class A type. For the class A type, please consult us.

COIL DATA (at 20°C 68°F)

Nominal voltage, V DC	Pick-up voltage, V DC (max.) (Initial)	Drop-out voltage, V DC (min.) (Initial)	Coil resistance, Ω (±10%)		Nominal operating power, mW		Max. allowable voltage, V DC (at 70°C 158°F)
			Open	PCB & TMP	Open	PCB & TMP	
5	3.75	0.5	26	31	962	800	6
6	4.5	0.6	38	45	947	800	7.2
9	6.75	0.9	94	101	862	800	10.8
12	9.0	1.2	155	180	930	800	14.4
15	11.25	1.5	256	281	879	800	18
18	13.5	1.8	380	405	853	800	21.6
24	18.0	2.4	660	720	873	800	28.8

DIMENSIONS

mm inch

1. PCB type

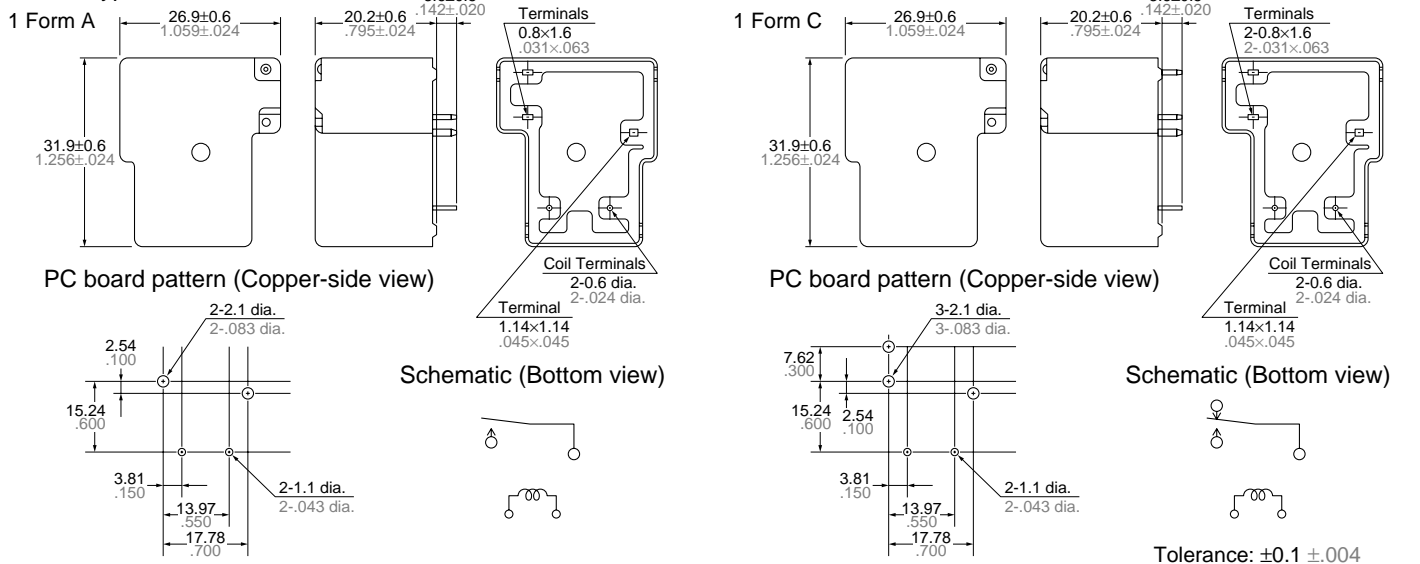

2. TMP type

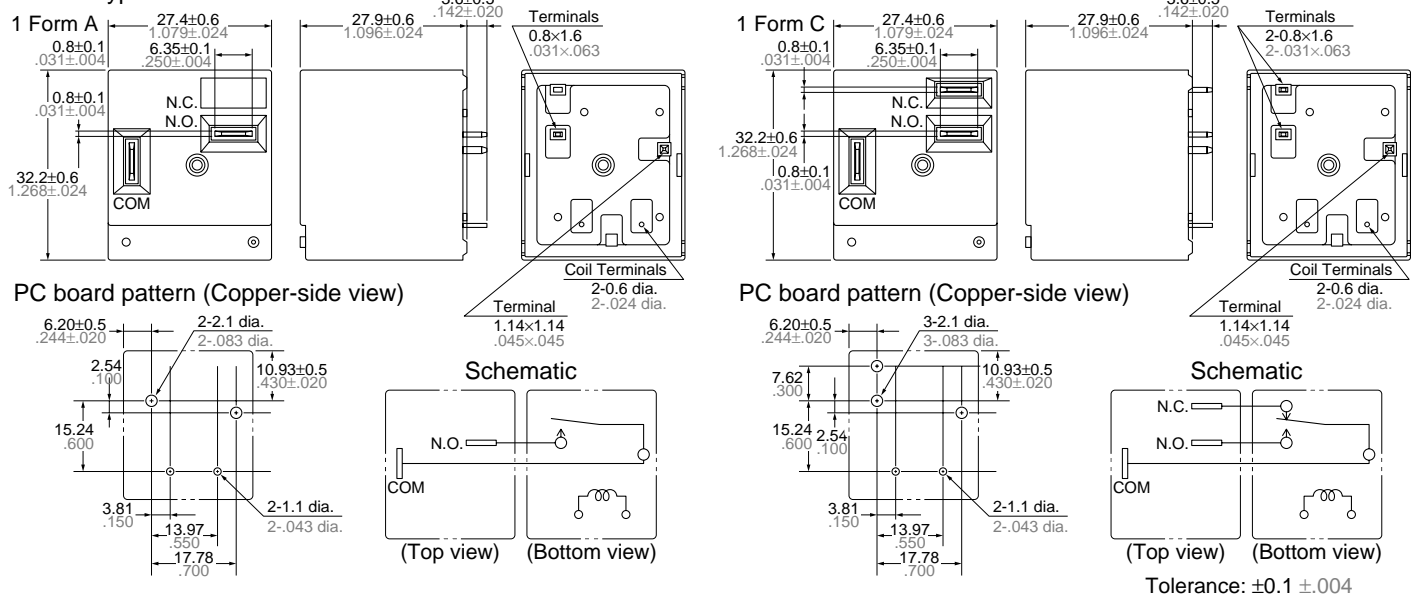

JT-N-JT

3. Open type

1 Form A

mm inch

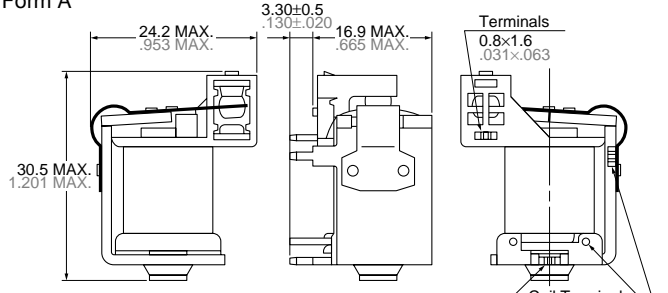

1 Form C

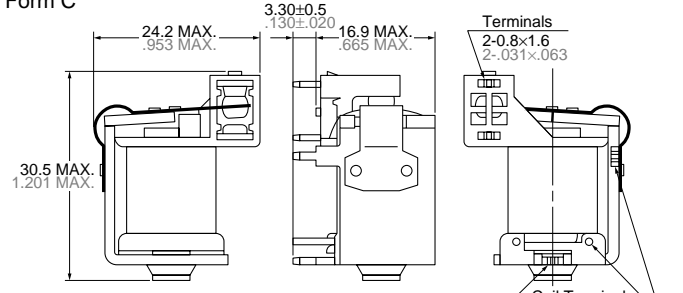

PC board pattern (Copper-side view)

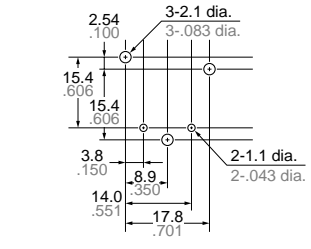

Schematic (Bottom view)

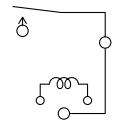

PC board pattern (Copper-side view)

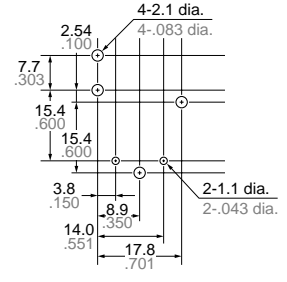

Schematic (Bottom view)

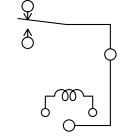

Tolerance: ±0.1 ±0.04

REFERENCE DATA

1. Change of rate of pick-up and drop-out voltage (at 20°C 68°F)
Sample: JTN1S-TMP-F-DC24V (6 pcs.)

2. Operate & release time (at 20°C 68°F)
Sample: JTN1S-TMP-F-DC24V (6 pcs.)

3. Operate & release time (at 20°C 68°F)
Sample: JTN1aS-TMP-F-DC24V (6 pcs.)

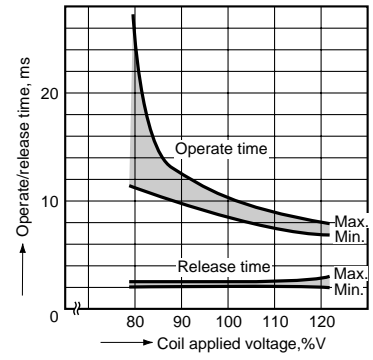
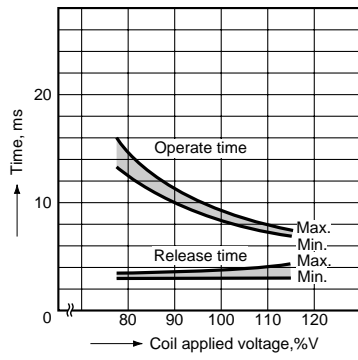
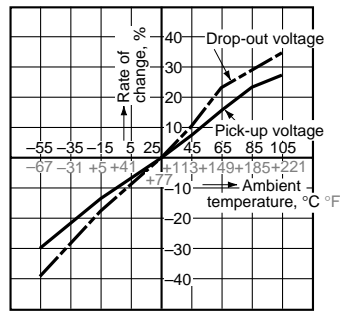

4. Distribution frequency of pick-up voltage (at 20°C 68°F)
Sample: JTN1S-TMP-F-DC12V (30 pcs.)

5. Distribution frequency of drop-out voltage (at 20°C 68°F)
Sample: JTN1S-TMP-F-DC12V (30 pcs.)

6.-(1) Coil temperature rise (TMP type)*
Ambient temperature: 20°C 68°F
Sample: JTN1aS-TMP-F-DC12V (6 pcs.)

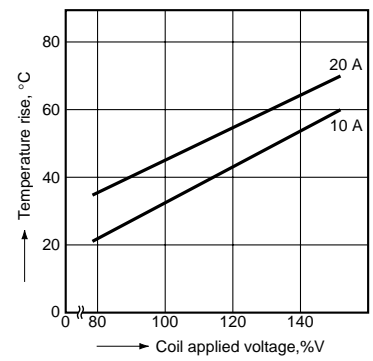
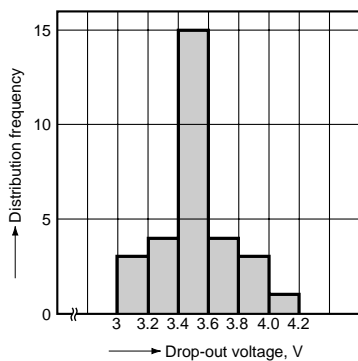
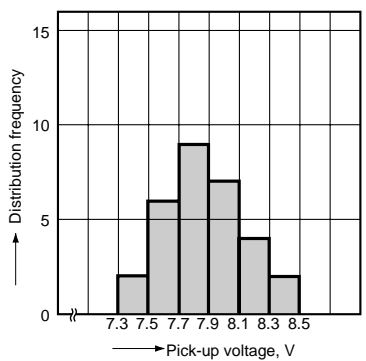

* Coil temperature rise of sealed types are same as data of the dust cover type.

Ambient temperature: 55°C 131°F
Sample: JTN1aS-TMP-F-DC12V (6 pcs.)

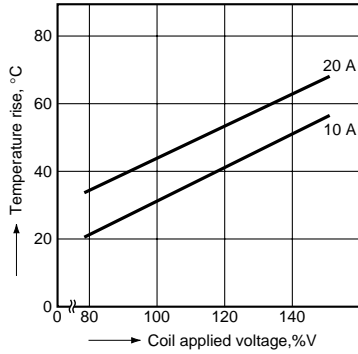

Ambient temperature: 85°C 185°F
Sample: JTN1aS-TMP-F-DC12V (6 pcs.)

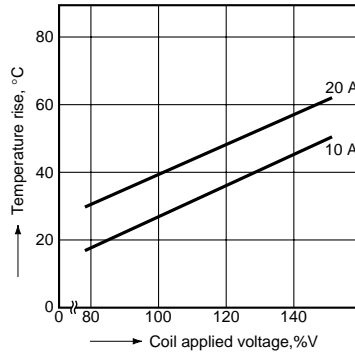

Ambient temperature: 105°C 221°F
Sample: JTN1aS-TMP-F-DC12V (6 pcs.)

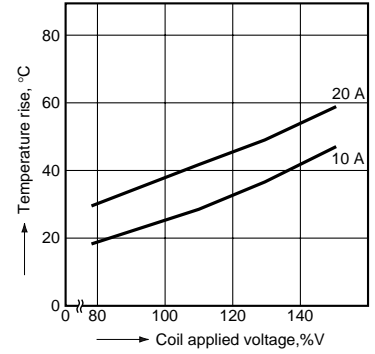

6.-(2) Coil temperature rise (Open type)

Ambient temperature: 20°C 68°F
Sample: JT1a-DC12V (6 pcs.)

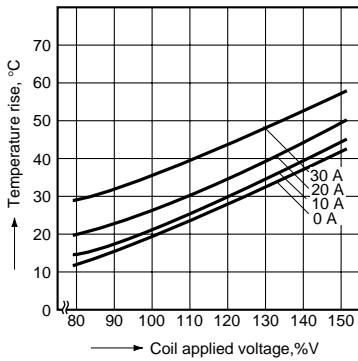

Ambient temperature: 50°C 122°F
Sample: JT1a-DC12V (6 pcs.)

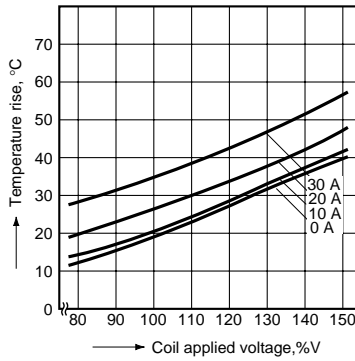

Ambient temperature: 85°C 185°F
Sample: JT1a-DC12V (6 pcs.)

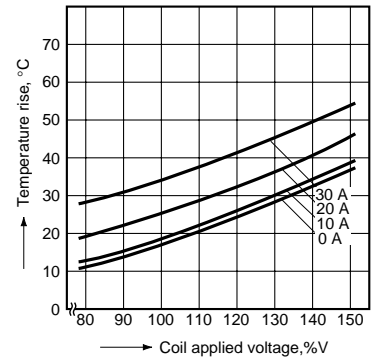

For Cautions for Use, see Relay Technical Information (Page 48 to 76).