

The TS105-4 is a thermopile sensor for use in long range contactless temperature measurement

Thermopiles are mainly used for contactless temperature measurement in many applications. Their function is to transfer the heat radiation emitted from the objects into voltage output. Major applications are appliances like microwave oven, clothes dryer, automatic cooking, medical devices like ear and forehead thermometer, automotive applications like car climate control, seat occupancy, blind spot alert, black ice detection, consumer products like printer, copier, mobile phone and many industry applications like paper web, plastic parts etc.

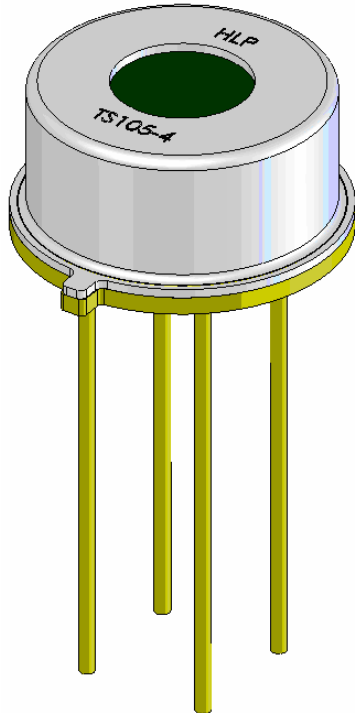

Parameter	Typical	Condition
Package	TO-5	
Absorber Area	0.7×0.7 mm ²	
Resistance of Thermopile	43±8 kΩ	+25 °C
TC of Resistance	-0.06±0.04 %/K	+25°C → +75°C
Thermopile Voltage	3.3±0.85 mV	+25°C, BB +100°C,DC totally filled field of view
TC of sensitivity	-0.45±0.08 %/K	+25°C → +75°C
Noise Equivalent Voltage	30 nV/Hz ^{1/2}	+25°C
Rise Time	20±5 ms	τ ₆₃
Field of View	90°	
Filter	8-14 μm	band pass
Operation Temperature	-20 ... +85°C	
Operation Temperature	-20 ... +100°C	non permanent
Ambient Temperature Sensor	--	
Connections		
Pin 1	TP -	
Pin 2	TP +	
Pin 3	--	
Pin 4	GND	

Mechanical Dimensions

TOP VIEW

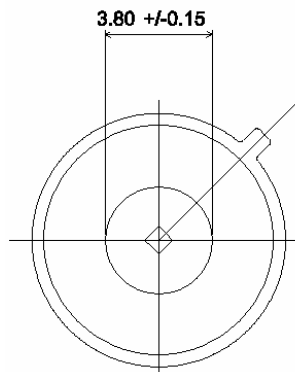

SIDE VIEW

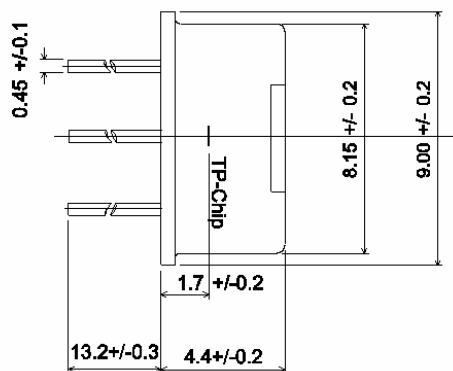

BOTTOM VIEW

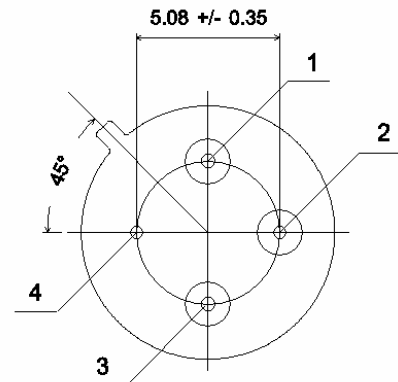

Connections Bottom View

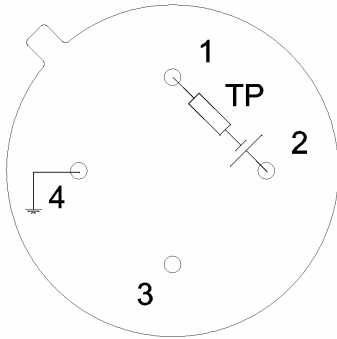

Filter Transmission

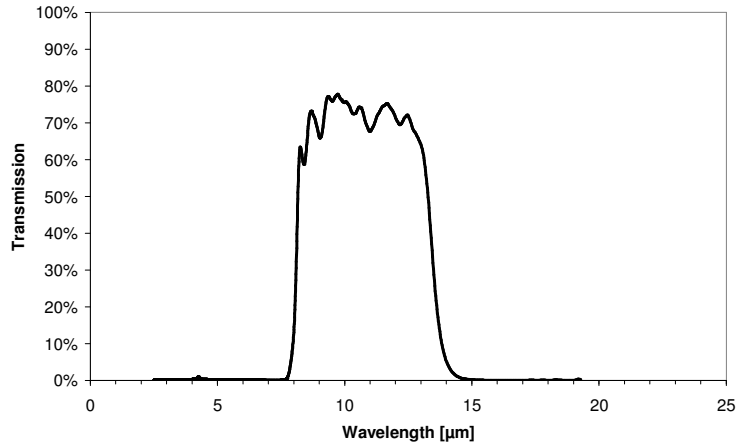

Thermopile Signal

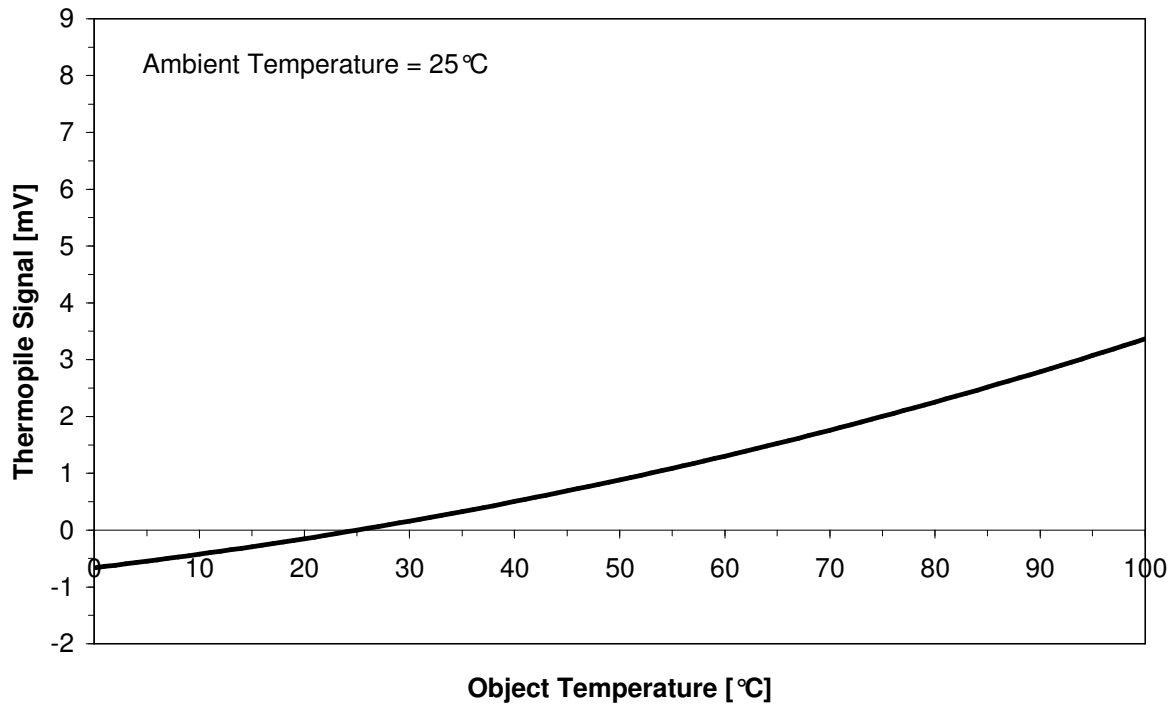

Additional products with different filters and packages are also available.

Specifications are subject to change without notice !