

Set SlimLine

Type 9130BA... to 9137BA...

with Integrated, Single-Component SlimLine Force Sensors

Ready-to-connect compact assembly kit with integrated, single-component SlimLine (SL) force sensors. 2, 3 or 4 ultra-flat quartz sensors are contained in a fixed connection. Measurement of the total force (total signal) or partial force (individual signal) per sensor can be made with an appropriate connecting cable.

The SlimLine kit is supplied **uncalibrated**. The sensors must be calibrated in situ **after** mounting.

- Flexible, compact installation in structures
- Total or individual signals
- Cable length can be chosen for each sensor
- Sensors ground level

Description

The SlimLine kit consists of 2, 3 or 4 SLS sensors connected permanently to a connector. The cable length of the sensors can be individually selected between 0,1 m and 2 m. The total force F to be measured is applied to the sensors through special preloaded or fitted elements. Each loaded sensor produces an electric charge proportional to its force component. The charge signals are fed out through electrodes and integrated cables.

The individual sensor cables in the SL kit are connected permanently to a special 7-pole connector. The sensor signals in it are individually fed to the corresponding pin positions. The further signal processing can be determined by an appropriate connecting cable. The following versions are possible:

- Total signal (through connecting cable Type 1971A..., connector connected in parallel):
Measurement of the total force F . The partial forces on each sensor are summed to give the total force.
- Individual signals (through connecting cable Type 1973A..., connector connected in series):
Measurement of specific forces (force components) acting on the individual sensors.

Application

As a result of their great rigidity, SlimLine sensors are particularly suitable for the measurement of rapidly changing forces. Quasistatic measurements over several minutes are possible.

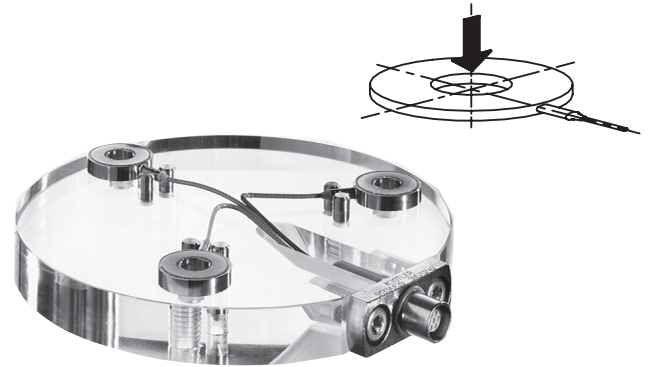

The SL assembly is particularly suitable for the measurement of forces in force shunt mode. This means that the sensors are embedded and preloaded in an/a environmental/surrounding structure. Thanks to its small design, the sensor can be installed in structures like force plates, fitting strips and follow-on tools. The sensor is used in industrial production processes where forces must be monitored or measured. Connected to a control monitor, the sensor is ideal for quality control and monitoring of production series.

Application Examples

- Monitoring of press forces, punching forces etc.
- Monitoring follow-on tools
- Measuring large forces in force shunts
- Mounting in dynamometers with small dimensions

Technical Data

SlimLine Kit	SlimLine Sensor	Range (kN)	Overload (kN)	Sensitivity (pC/N)
9130BA...	9130B...	0 ... 3,0	3,5	≈-3,5
9132BA...	9132B...	0 ... 7,0	8	≈-3,8
9133BA...	9133B...	0 ... 14	17	≈-3,8
9134BA...	9134B...	0 ... 26	30	≈-3,8
9135BA...	9135B...	0 ... 36	42	≈-3,8
9136BA...	9136B...	0 ... 62	72	≈-3,8
9137BA...	9137B...	0 ... 80	96	≈-3,8

9130BA_000-694e-12.11

Further Technical Data

Linearity (preloaded)	%/FSO	≤±1,0
Hysteresis (preloaded)	%/FSO	≤1,0
Threshold	N	<0,01
Operating temperature range	°C	-20 ... 120
Preloading force (recommended)	F _v	
direct force measurement ¹⁾	%/FS	≈50
force shunt measurement	%/FS	≈20
Degree of protection ²⁾	EN60529	IP65

¹⁾ The preload force is chosen accordingly by the desired tensile/press force range.

²⁾ The degree of protection according EN60529 is determined by water, oil, emulsions, cooling lubricant etc. have mostly a better wetting and penetration ability. The degree of protection in contact with such liquid is classified accordingly lower.

Dimensions of the Individual Sensors

Set SlimLine	External diameter (mm)	Internal diameter (mm)	Height (mm)
9130BA...	8	2,7	3
9132BA...	12	4,1	3
9133BA...	16	6,1	3,5
9134BA...	20	8,1	3,5
9135BA...	24	10,1	3,5
9136BA...	30Pre	12,1	4
9137BA...	36	14,1	5

Mounting

The SlimLine sensors should be mounted only with preloading in a structure or with mounting elements. The mounting accessories from Kistler should be used for preference. As far as possible, grinding of mounting surfaces should be carried out (Fig. 1). If fine grinding of the mounting surfaces is not possible, they must be at least flat and rigid. The mounting produces a force shunt which results in a reduction in sensitivity of the individual sensor.

The SlimLine kit is supplied uncalibrated. Only after mounting can the sensitivity be determined through calibration.

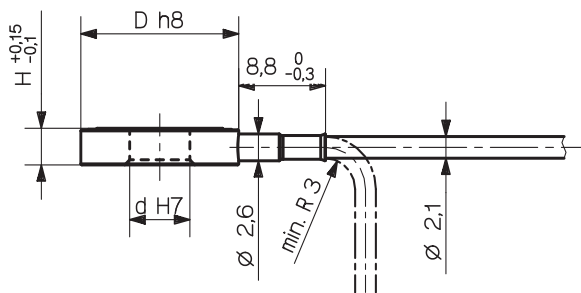

Fig. 1: Dimensions SlimLine sensor

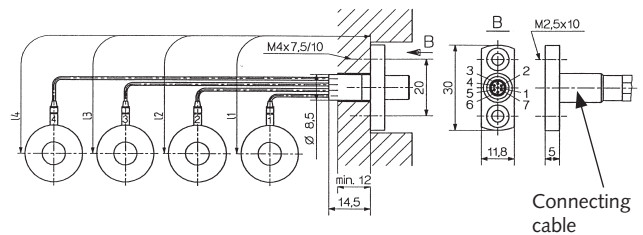
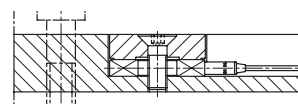
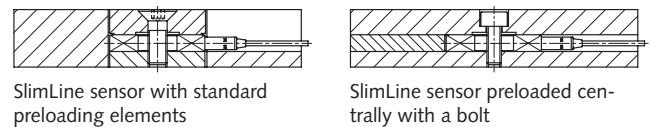

Fig. 2: SlimLine Kit

Mounting Variations of Individual SLS Sensors in Force Shunt Mode

The SlimLine sensor installed in force shunt mode can solve the widest variety of measuring problems. The following mounting versions show the flexibility of mounting the sensor in a structure.



SlimLine sensor embedded in structure and preloaded with a head piece

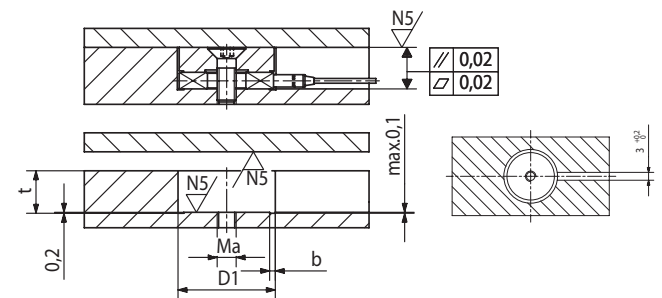

Fig. 3: Shunt mounting with preloading disk

SL Sensor for Type	Thread (Ma)	Bore diam. ø D1	Bore depth t	Undercut with b
9130BA...	M2,5	8,5	6,5	0,8
9132BA...	M4	12,5	6,5	1,2
9133BA...	M6	16,5	7,7	1,2
9134BA...	M8	20,5	7,7	1,2
9135BA...	M10	24,5	7,7	1,5
9136BA...	M12	30,5	10,0	1,5
9137BA...	M14	36,5	12,0	1,5

Connecting Cable

Connecting Cable for Total Signal (Sums All)

Type 1971A1..., Plug connection: BNC pos.

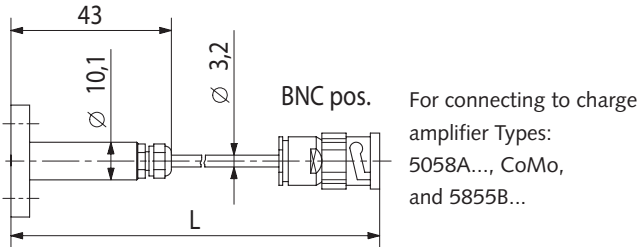

Type 1971A2..., Plug connection: Mini-Coax neg.

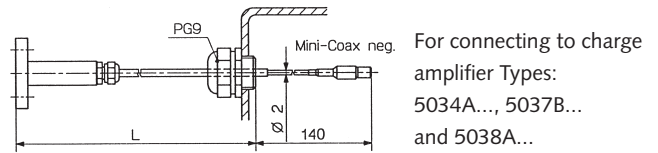

Connecting Cable for Single Signal

Type 1973A1..., Plug connection: BNC pos.

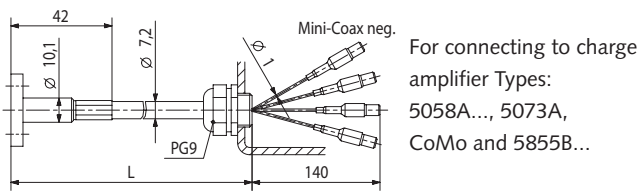

Type 1971A2..., Plug connection: Mini-Coax neg.

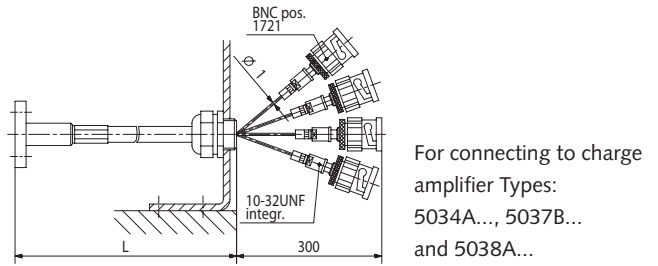

Preloading Disk

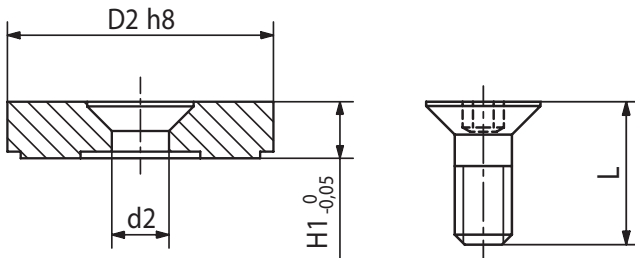

Fig. 4: One countersunk screw is delivered with each preloading disk.

Type	9410A0	9410A2	9410A3	9410A4	9410A5	9410A6	9410A7
for SLS Type	9130B...	9132B...	9133B...	9134B...	9135B...	9136B...	9137B...
Thread	M2	M2,5	M3	M4	M5	M6	M8
Outer-ø D2	8,0	12,0	16,0	20,0	24,0	30,0	36,0
Inner-ø d2	2,7	2,7	3,2	4,3	5,3	6,4	8,4
Disk thickness H1	3,5	3,5	4,25	4,25	4,25	5,5	7,0
Screw length L	8,0	8,0	10,0	10,0	10,0	14,0	16,0

9130BA_000-694e-12.11

Optional Accessories

- | | Type |
|--|-------------|
| • Preloading disk for SL Kit
Type 9130BA... | 9410A0 |
| • Preloading disk for SL Kit
Type 9132BA... | 9410A2 |
| • Preloading disk for SL Kit
Type 9133BA... | 9410A3 |
| • Preloading disk for SL Kit
Type 9134BA... | 9410A4 |
| • Preloading disk for SL Kit
Type 9135BA... | 9410A5 |
| • Preloading disk for SL Kit
Type 9136BA... | 9410A6 |
| • Preloading disk for SL Kit
Type 9137BA... | 9410A7 |

Ordering Key for Set SlimLine

Type 913 BA 9

Measuring Range

Kit with SL sensor Type 9130B...	0
Kit with SL sensor Type 9132B...	2
Kit with SL sensor Type 9133B...	3
Kit with SL sensor Type 9134B...	4
Kit with SL sensor Type 9135B...	5
Kit with SL sensor Type 9136B...	6
Kit with SL sensor Type 9137B...	7

Kit with 2 sensors	2
Kit with 3 sensors	3
Kit with 4 sensors	4

Specify cable length for each cable separately
l = 0,1 ... 2 m
(l1 = ..., l2 = ..., etc)

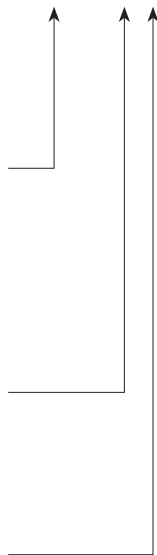

9130BA_000-694e-12.11