

Cable

Type KSM...

for Torque Sensors Type 4501A... to 4504A...

Type KSM007186 Connection cable for amplifier Type 4701AxB and torque sensor Type 4501A... (0143SD) version Q/R/H
Type KSM071860 Connection cable with customised length

Contacts 6
 Length (m) L = 5 m; customised length, Type KSM071860
 Cable LIYCY 5x0,25 transparent
 Temperature range 0 ... 70 °C

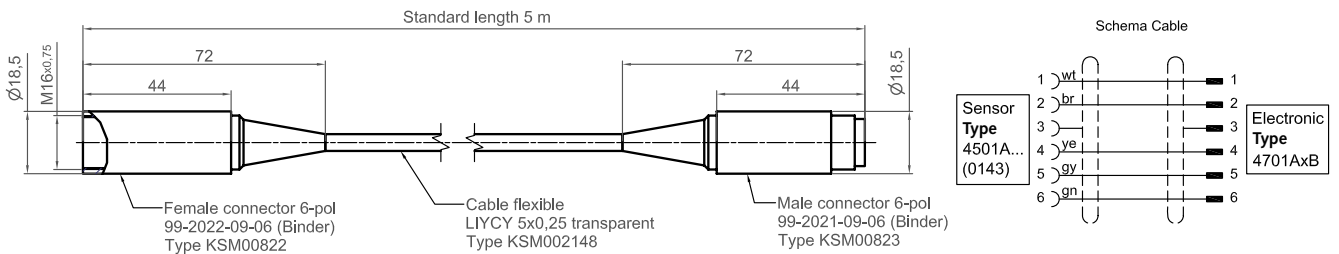

Application Strain gage (DMS) torque measurement
 Female connector M16x0,75 6-pol ø18,5, Type KSM000822
 Male connector: ø18,5, Type KSM000823
 Shell protection IP40

Type KSM010382 Connection cable for amplifier Type 4701AxA and torque sensor Type 4501A... (0143SD) version Q/R/H
Type KSM103820 Connection cable with customised length

Contacts 6
 Length (m) L = 5 m; customised length, Type KSM010382
 Cable LIYCY 5x0,25 transparent, one side with open ends
 Temperature range 0 ... 70 °C

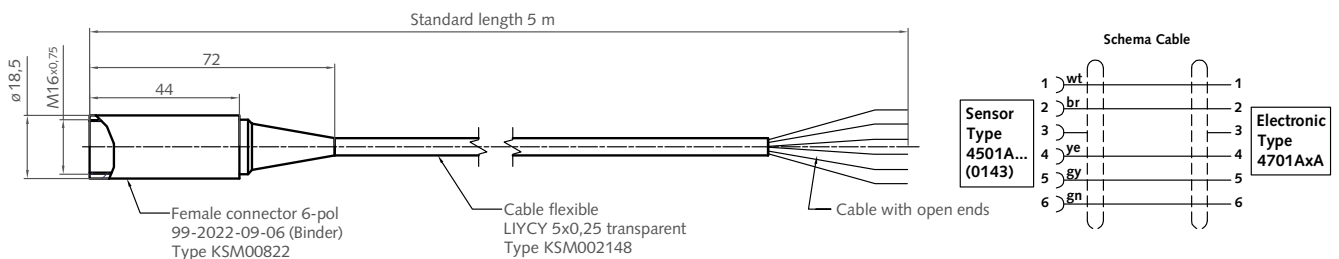

Application Strain gage (DMS) torque measurement
 Female connector M16x0,75 6-pol ø18,5, Type KSM000822
 Shell protection IP40

KSM_000-615e-01.07

Type KSM017069 Connection cable for amplifier Type 4731A... and torque sensor Type 4501A... (0143SD) version QA

Contacts 12
Length (m) L = 5 m
Cable LIYCY 12x0,14 transparent
Temperature range 0 ... 70 °C

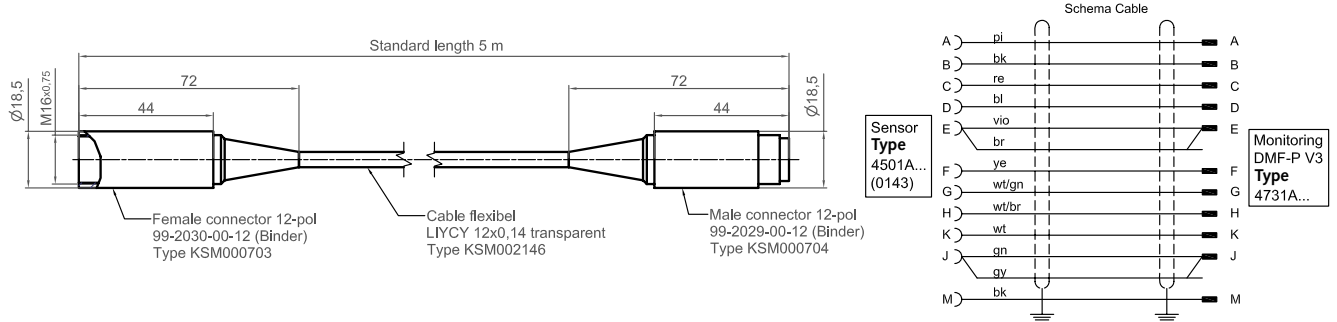

Application Strain gage (DMS) torque measurement
Female connector M16x0,75 12-pol ø18,5, Type KSM000703 Male connector: ø18,5, Type KSM000704
Shell protection IP40

Type KSM018315 Connection cable for torque sensor Type 4501A... (0143SD) version QA/HA

Contacts 12
Length (m) L = 5 m
Cable LIYCY 12x0,14 transparent, one side with open ends
Temperature range 0 ... 70 °C

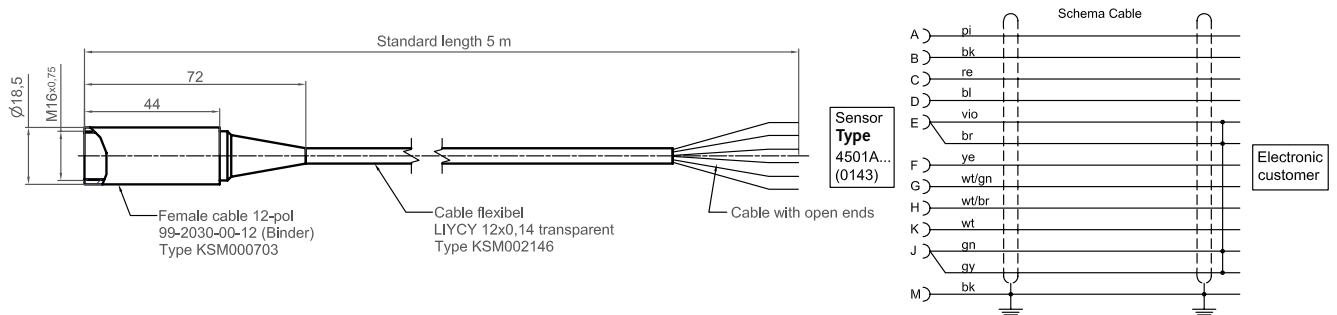

Application Strain gage (DMS) torque measurement
Female connector M16x0,75 12-pol ø18,5, Type KSM000703
Shell protection IP40

KSM_000-615e-01.07

Type KSM007203 Connection cable for monitoring DMF-P V3 Type 4731A... and torque sensors Type 4502A... (0170MS), Type 4503A... (0260DM), Type 4504A... (0325DF)
Type KSM072030 Connection cable with customised length

Contacts 12
 Length (m) L = 5 m; customised length, Type KSM072030
 Cable LIYCY 12x0,14 transparent
 Temperature range 0 ... 70 °C

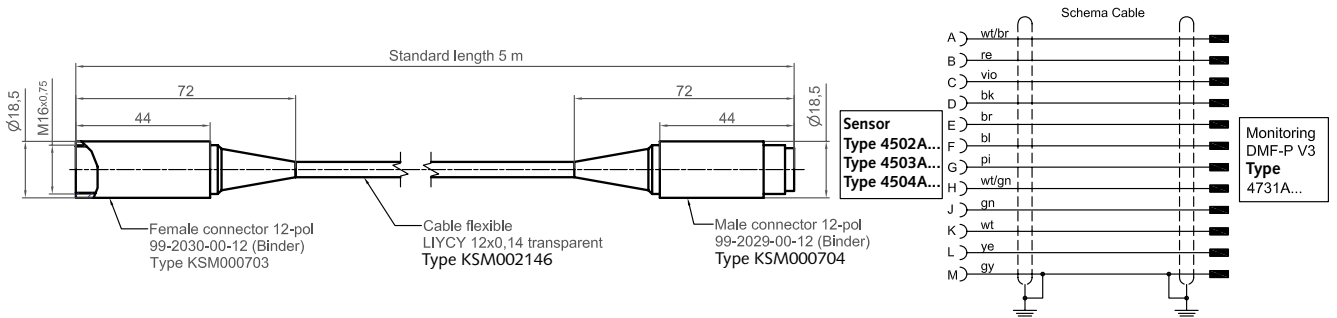

Application Torque measurement with contactless signal transmission
 Female connector M16x0,75 12-pol ø18,5, Type KSM000703 Male connector: ø18,5, Type KSM000704
 Shell protection IP40

Type KSM012497 Connection cable for electric customer and torque sensor Type 4502A... (0170 MS), Type 4503A... (0260DM), Type 4504A... (0325DF)
Type KSM124970 Connection cable with customised length

Contacts 12
 Length (m) L = 5 m; customised length, Type KSM124970
 Cable LIYCY 12x0,14 transparent, one side with open ends
 Temperature range 0 ... 70 °C

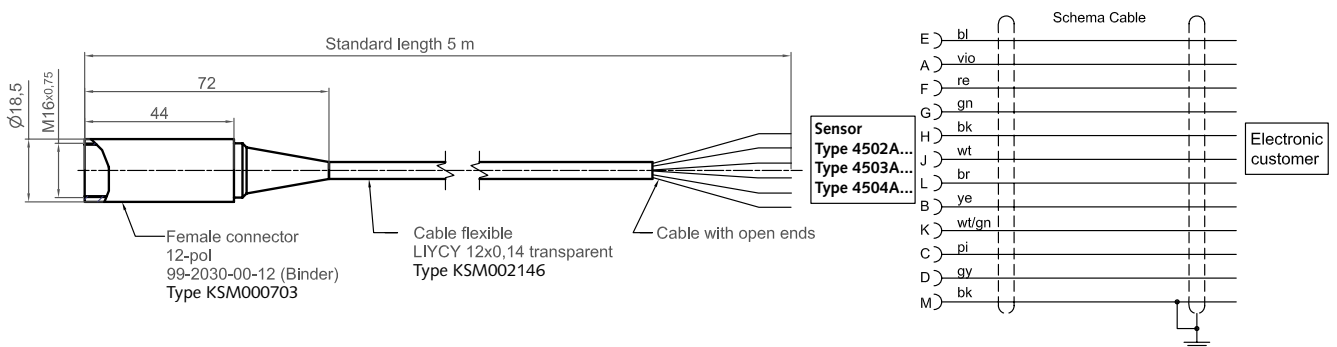

Application Torque measurement with contactless signal transmission
 Female connector M16x0,75 12-pol ø18,5, Type KSM000703
 Shell protection IP40

KSM_000-615e-01.07

Type KSM021971 Connection cable for Type 4503A... (0260DM), Type 4504A... (0325DF) and RS-232C output
Type KSM219710 Connection cable with customised length

Contacts 7
 Length (m) L = 5 m; customised length, Type KSM219710
 Cable LIYCY 7x0,25 transparent, one side with open ends
 Temperaturbereich 0 ... 70 °C

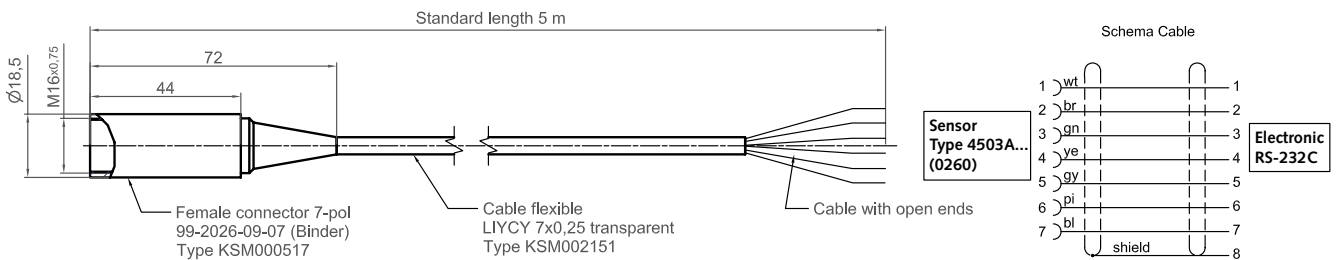

Application To connect RS-232C output and select range of Type 4503A...(0260DM)
 Female connector M16x0,75 7-pol $\varnothing 18,5$, Type KSM00517
 Shell protection IP40

Type KSM021468 Connection cable for Type 4503A... (0260DM), Type 4504A... (0325DF) and RS-232C output
Type KSM214680 Connection cable with customised length

Contacts 7
 Length (m) L = 5 m; customised length, Type KSM214680
 Cable LIYCY 7x0,25 transparent
 Temperaturbereich 0 ... 70 °C

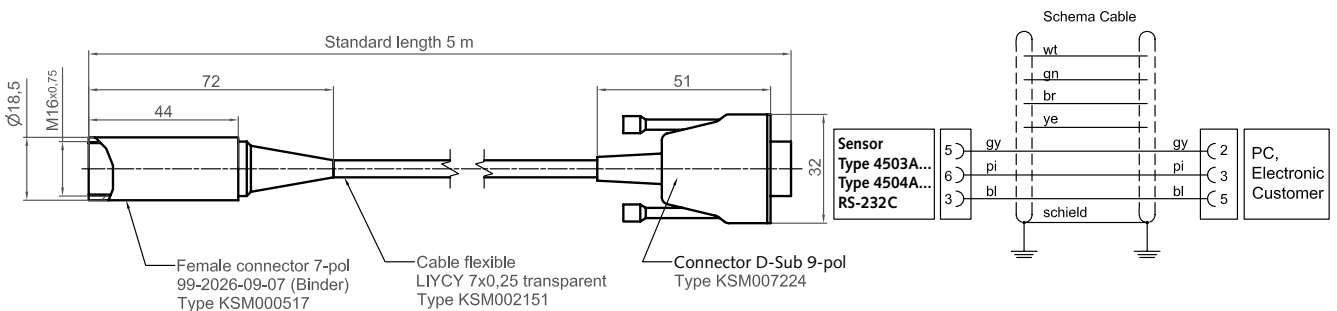

Application To connect RS-232C output and select range of Type 4503A...(0260DM)
 Female connector M16x0,75 7-pol $\varnothing 18,5$
 Shell protection IP40 Male Connector: D-Sub 9-pol Type KSM007224

KSM_000-615e-01.07

Type KSM027026 Connection cable for torque sensor Type 4504A (0325DF)... plug C
Type KSM270260 Connection cable with customised length

Contacts 7
 Length (m) L = 5 m; customised length, Type KSM270260
 Cable LIYCY 6x0,25 transparent
 Temperature range 0 ... 70 °C

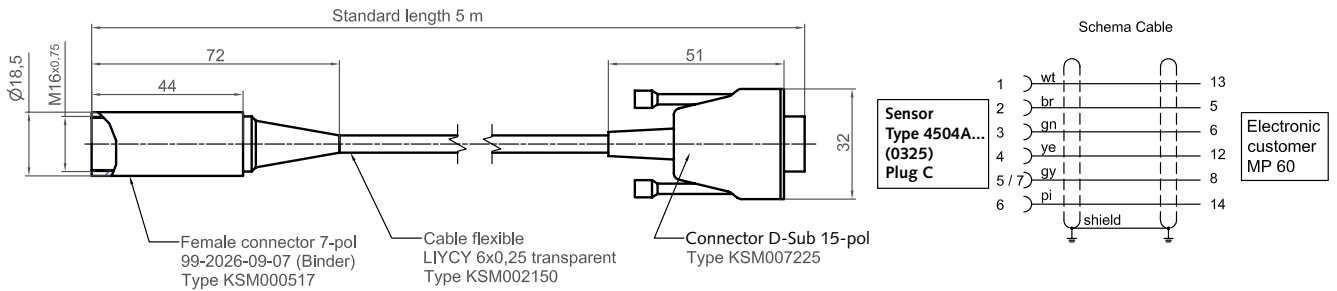

Application Torque measurement Type 4504A... plug C
 Female connector M16x0,75 7-pol ø18,5, Type KSM000517
 Shell protection IP40
 Male Connector: D-Sub 15-pol Type KSM007225

Type KSM027027 Connection cable for torque sensor Type 4504A... plug D
Type KSM270270 Connection cable with customised length

Contacts 8
 Length (m) L = 5 m; customised length, Type KSM270270
 Cable LIYCY 5x0,25 transparent
 Temperature range 0 ... 70 °C

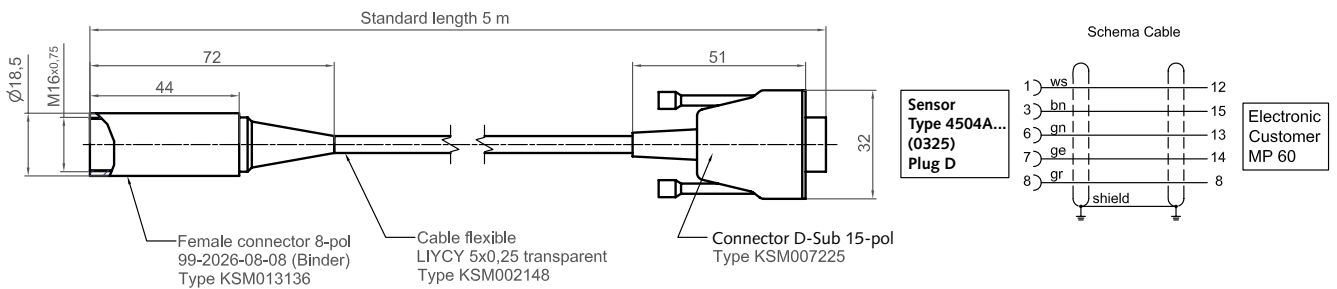

Application Speed / angle measurement Type 4504A... plug D
 Female connector M16x0,75 8-pol ø18,5, Type KSM013136
 Shell protection IP40
 Male Connector: D-Sub 15-pol Type KSM007225

KSM_000-615e-01.07

Type KSM018535 Connection cable for UMV 3000 Type 4700A..., torque sensor Type 4501A... (0143SD)
Type KSM185350 Connection cable with customised length

Contacts 6
 Length (m) L = 2,5 m; customised length, Type KSM185350
 Cable LIYCY 7x0,25 transparent
 Temperature range 0 ... 70 °C

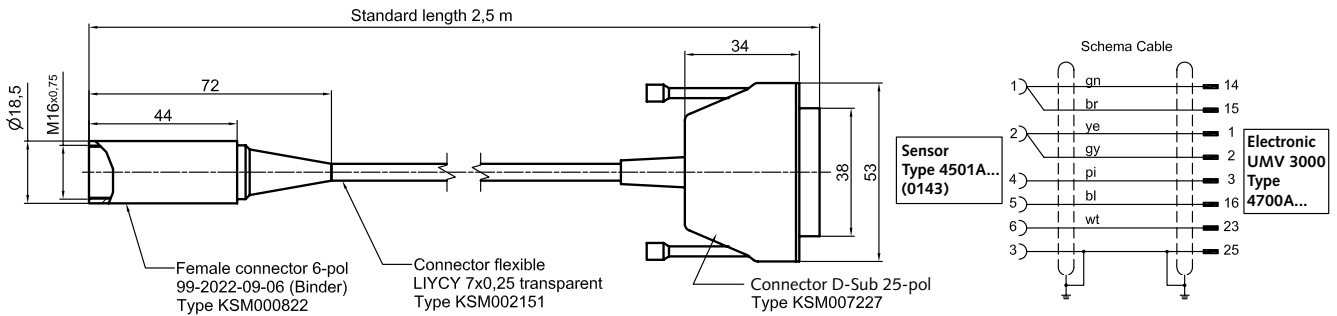

Application Torque measurement Type 4501A... (0143SD)
 Female connector M16x0,75 6-pol ø18,5, Type KSM000822 Male Connector: D-Sub 25-pol Type KSM007227
 Shell protection IP40

Type KSM018537 Connection cable for UMV 3000 Type 4700A..., torque sensor Type 4501A... (0143SD)
Type KSM185370 Connection cable with customised length

Contacts 12
 Length (m) L = 2,5 m; customised length, Type KSM185370
 Cable LIYCY 12x0,14 transparent
 Temperature range 0 ... 70 °C

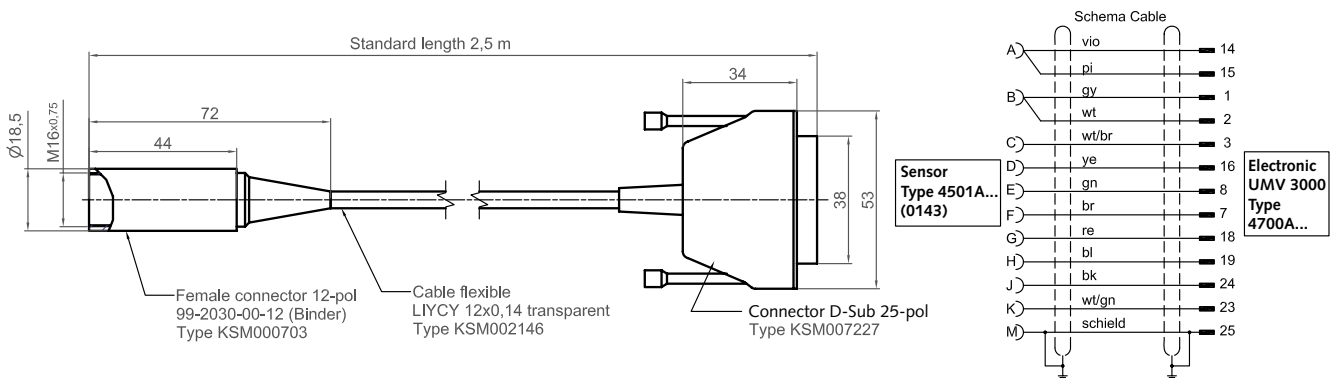

Application Torque / angle measurement Type 4501A... (0143SD)
 Female connector M16x0,75 12-pol ø18,5, Type KSM000703 Male Connector: D-Sub 25-pol Type KSM007227
 Shell protection IP40

KSM_000-615e-01.07

Type KSM018642 Connection cable for UMV 3000 Type 4700A..., torque sensor Type 4503A... (0260DM), Type 4504A... (0325DF)

Type KSM186420 Connection cable with customised length

Contacts 12
 Length (m) L = 2,5 m; customised length, Type KSM186420
 Cable LIYCY 12x0,14 transparent
 Temperature range 0 ... 70 °C

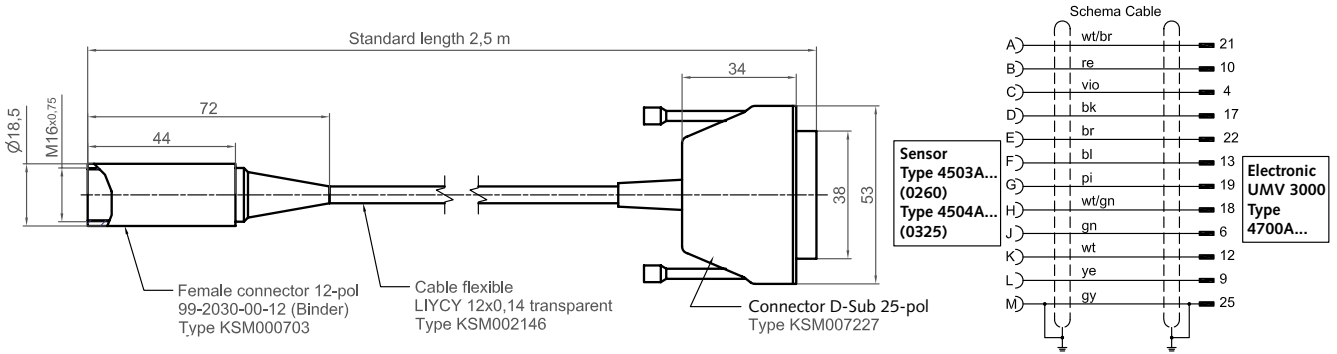

Application Torque / speed measurement Type 4503A... (0260DM), Type 4504A... (0325DF)
 Female connector M16x0,75 12-pol ø18,5, Type KSM000703 Male Connector: D-Sub 25-pol Type KSM007227
 Shell protection IP40

Type KSM018538 Connection cable for UMV 3000 Type 4700A..., torque sensor Type 4502A... (0170MS)

Type KSM185380 Connection cable with customised length

Contacts 12
 Length (m) L = 2,5 m; customised length, Type KSM185380
 Cable LIYCY 12x0,14 transparent
 Temperature range 0 ... 70 °C

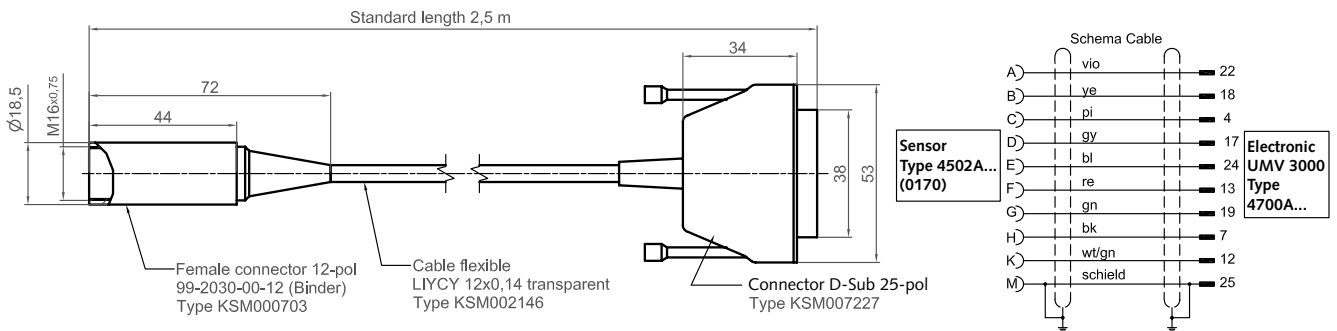

Application Torque / speed measurement Type 4501A... (0143SD)
 Female connector M16x0,75 12-pol ø18,5, Type KSM000703 Male Connector: D-Sub 25-pol Type KSM007227
 Shell protection IP40

KSM_000-615e-01.07

Type KSM000822 Female cable connector with solder eye

Contacts 6
 Temperature range -40 °C ... 85 °C
 Application Strain gage (DMS) torque measurement
 Female connector (Binder) 99-2022-09-06 series 581
 Shell protection IP40

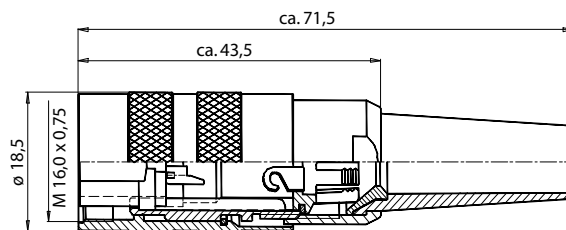

Type KSM000517 Female cable connector with solder eye

Contacts 7
 Temperature range -40 °C ... 85 °C
 Application RS-232C interface / select measuring range
 Female connector (Binder) 99-2026-09-07 series 581
 Shell protection IP40

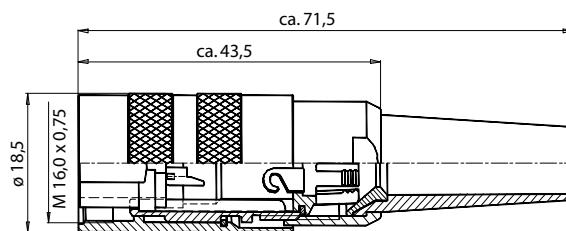

Type KSM013136 Female cable connector with solder eye

Contacts 8
 Temperature range -40 °C ... 85 °C
 Application Rotation speed / angle measurement
 Female connector (Binder) 99-2062-09-08 series 581
 Shell protection IP40

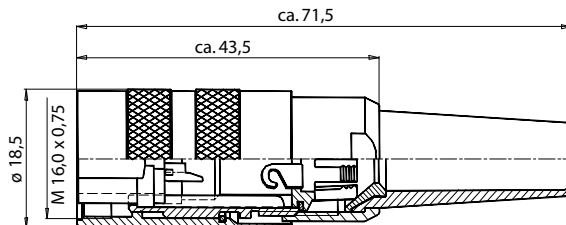

Type KSM000703 Female cable connector with solder eye

Contacts 12
 Temperature range -40 °C ... 85 °C
 Application Torque / speed / angle measurement
 Female connector (Binder) 99-2030-00-12 series 581
 Shell protection IP40

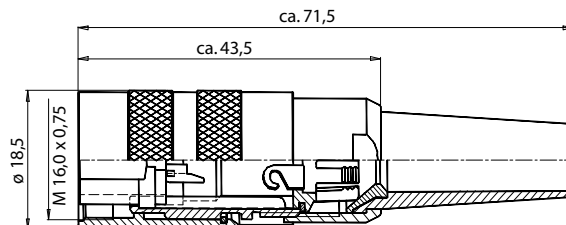

KSM_000-615e-01.07