

Datasheet - Standard Product

LME-345-#

pyroelectric detector

Description:

single channel; TO39 housing; medium chip size; thermal compensation; low Micro; OpAmp; current mode; feedback 24GOhm;



HOUSING:

PIN ASSIGNMENT:

TO39 4Pin
Bottom view

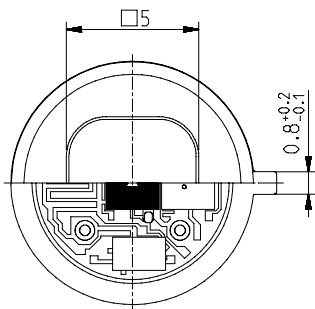
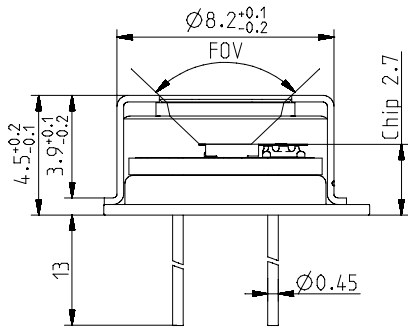
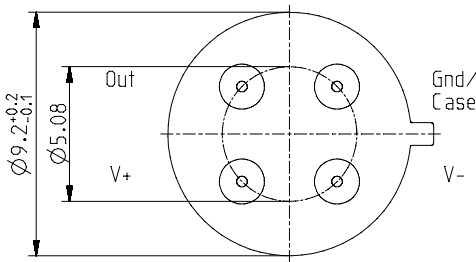

Top view

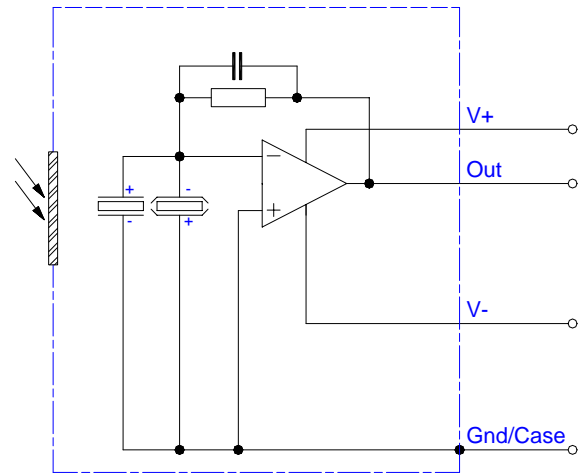

Maximum current between Case and the "Case"-Pin 10 mA!

FREQUENCY RESPONSE:

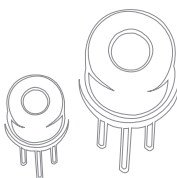
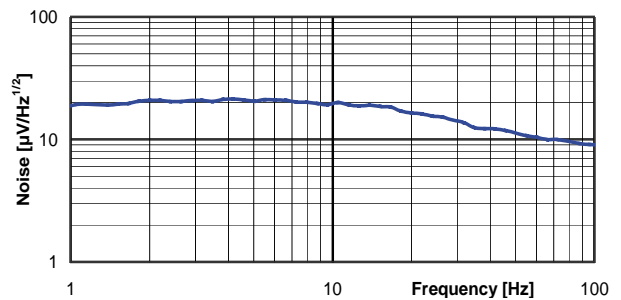
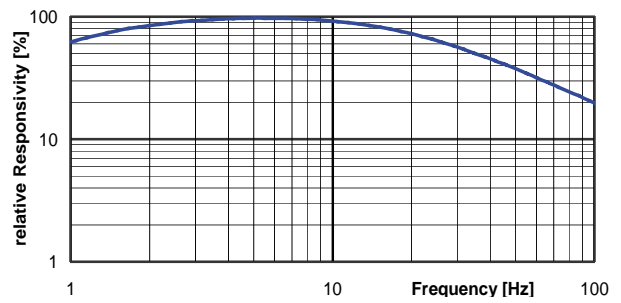

LME-345-#

pyroelectric detector

TEST CIRCUIT:

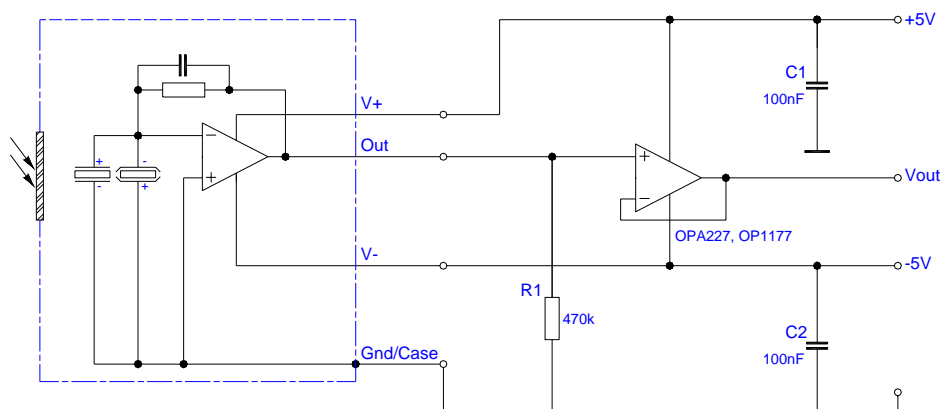

PARAMETERS:

Aperture size	nom	5.0 mm sq.
Element size / type	nom	2.0x2.0 mm ² lithium-tantalate with black layer
Thermal time constant	typ	150 ms
Feedback resistor	nom	24 GOhm ±10%
Feedback capacitor	nom	0.2 pF ±0.1 pF
Polarity	nom	negative signal by positive IR flux change
Voltage responsivity (rms) {500K, 10 Hz, 25 °C, without window}	min	33,000 V/W
Noise density (rms) {10 Hz, BW 1 Hz, 25 °C}	max	25 μV/(sqrt[Hz])
Detectivity {500K, 10 Hz, 1 Hz, 25 °C, without window}	min	2.6E+08 cm(sqrt[Hz])/W
Acceleration response {5 ... 200Hz}	typ	250 μV/g; g = 9.81 m/s ²
CMOS operational amplifier	nom	OpAmp2 (for characteristics see application note)
Supply voltage V+ - V-	max	16 V
Operating supply voltage V+ / V-		+2.2 ... 8.0 V / -2.2 ... -8.0 V
Recommended supply voltage V+ / V-	nom	V+ = +5 V; V- = -5 V
Supply current {output load 1MOhm}	max	150 μA
Offset voltage {25 °C; output load 1MOhm}		-5 mV ... +5 mV
Optimal output load	nom	330 kOhm
Absolute output current	max	±0.4 mA
Operating / Storage temperature	nom	-25 ... +85°C
IR window		All InfraTec windows and filters are available (except KBr and CsI). Customized filters upon request.
Filter sizes	nom	rectangular filters: (5.25 x 5.25) mm +0/-0.05 mm circular filters: ø6.5 mm ±0.1 mm standard thickness: 0.50 mm +0.2/-0.1 mm thickness range 0.70 ... 1.10 mm on request
Field of View	min	CaF ₂ or BaF ₂ ; 0.4 mm thick: 80° Silicon substrate; 0.5 mm thick: 90°