

SP-12A

FIS GAS SENSOR SP-12A

for METHANE DETECTION

The SP-12A is a tin di-oxide semiconductor gas sensor which has a good sensitivity and excellent selectivity to methane. The SP-12A has also a significant feature in good stability after exposure to silicone compounds. Using the SP-12A, the most reliable methane detection can be achieved.

Structure

Gas sensitive semiconductor material is formed on the alumina substrate on which the gold electrodes are printed. A thick film heater of ruthenium oxide is printed on the reverse of the substrate and placed in the plastic housing (Fig 1).

Operating conditions

Fig 2 shows the standard operating circuit for this model. The change of the sensor resistance (R_S) is obtained as the change of the output voltage across the fixed or variable resistor (R_L). In order to obtain the best performance and specified characteristics, the values of the heater voltage (V_H), circuit voltage (V_C) and load resistance (R_L) must be within the range of values given in the standard operating conditions shown in the Specification table on the next page.

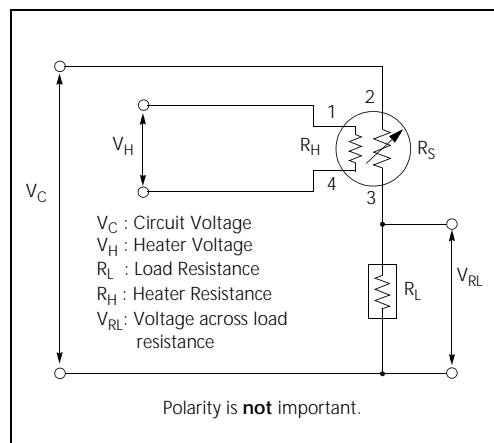

Fig 2. Standard circuit

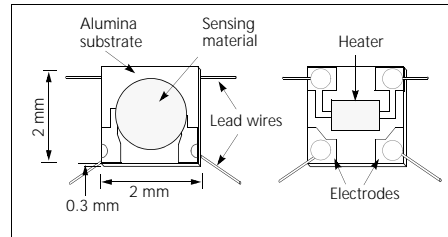

Fig 1a. Sensing element

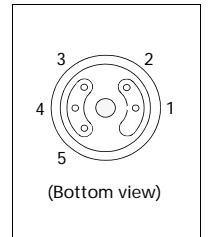

Fig 1c. Pin Layout

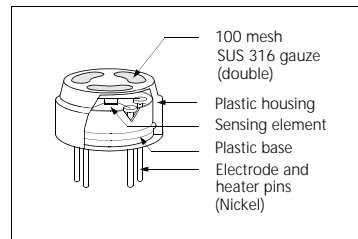

Fig 1b. Configuration

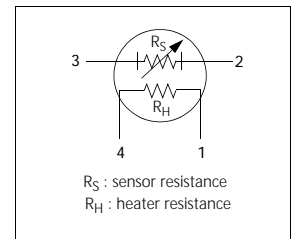

Fig 1d. Equivalent circuit

Sensitivity characteristics

Fig 3 shows the sensitivity characteristics curves of the SP-12A (typical data). Sensitivity characteristics of the FIS gas sensors are expressed by the relationship between the sensor resistance and gas concentration. The sensor resistance decreases with an increase of gas concentration based on a logarithmic function.

The sensitivity characteristics of the SP-12A is specified by the following parameters.

- Sensor resistance level: at methane 5000 ppm
- Sensor resistance change ratio: between methane 3000 ppm and 7000 ppm

See the specification table on the next page for further details.

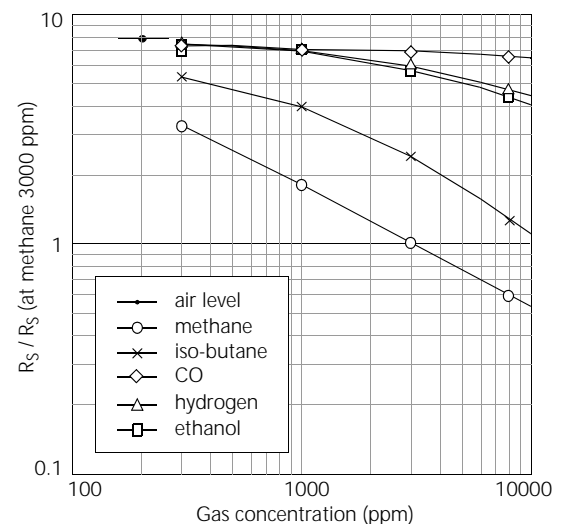

Fig 3. Sensitivity characteristics

SPECIFICATIONS

SP-12A

Specifications

A. Standard operating conditions

Symbol	Parameter	Specification	Conditions etc.
V_H	Heater voltage	$5.0\text{ V} \pm 4\%$	AC or DC
V_C	Circuit voltage	$5.0\text{ V} \pm 4\%$	AC or DC
R_L	Load resistance	Variable	$P_S < 15\text{ mW}$
R_H	Heater resistance	$42\ \Omega \pm 2\ \Omega$	At room temperature
P_H	Heater power consumption	380 mW (Typical value)	$P_H = V_H^2 / R_H$
P_S	Power dissipation of sensing element	Less than 15 mW	$P_S = \frac{(V_C - V_{RL})^2}{R_S}$

B. Environmental conditions

Symbol	Parameter	Specification	Conditions etc.
T_{ao}	Operating temperature	$-10\text{ }^\circ\text{C}$ to $60\text{ }^\circ\text{C}$	Recommended range
T_{as}	Storage temp	$-20\text{ }^\circ\text{C}$ to $70\text{ }^\circ\text{C}$	
RH	Relative humidity	Less than 95% RH	
(O_2)	Oxygen concentration	$21\% \pm 1\%$ (Standard condition)	Absolute minimum level: more than 18%
		The sensitivity characteristics are influenced by the variation in oxygen concentration.	

C. Sensitivity characteristics

Model	SP-12A-00,		
Symbol	Parameter	Specification	Conditions etc.
R_S	Sensor resistance	4 k Ω to 15 k Ω	At 5000 ppm of methane/air
β	Sensitivity slope	0.60 to 0.75	$\frac{R_S \text{ at } CH_4\ 7000\text{ ppm}}{R_S \text{ at } CH_4\ 3000\text{ ppm}}$
Standard Test Conditions: Temp: $20\text{ }^\circ\text{C} \pm 2\text{ }^\circ\text{C}$ V_C : $5.0\text{ V} \pm 1\%$ Humidity: $65\% \pm 5\%$ V_H : $5.0\text{ V} \pm 1\%$ (in clean air) R_L : $10\text{ k}\Omega \pm 5\%$ Pre-heating time: more than 48 hours			

D. Mechanical characteristics

Items	Conditions	Specifications
Vibration	Frequency: 100 cpm	Should satisfy the specifications shown in the sensitivity characteristics.
	Vertical amplitude: 4 mm	
	Duration: 1 hour	
Shock	Acceleration: 100 G	
	Number of impacts: 5 times	

Dimensions

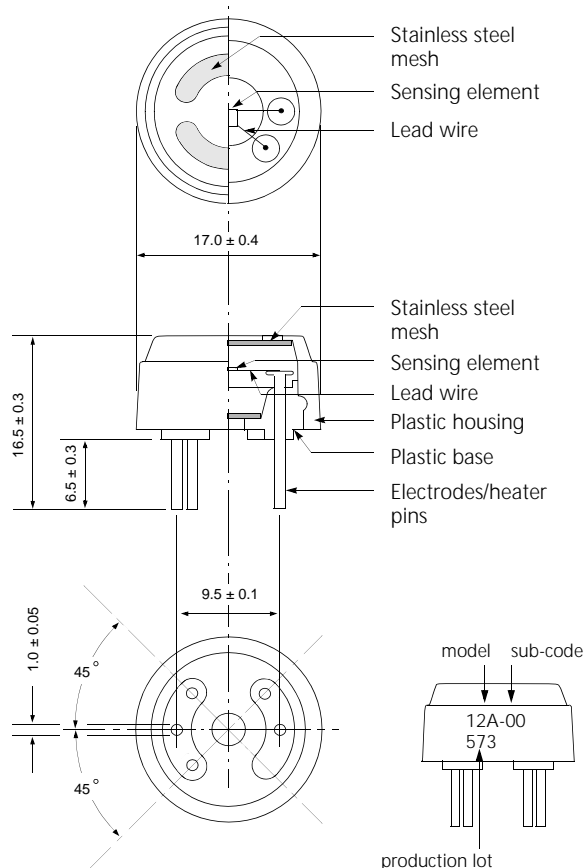

Scale: mm

Weight : 1.75g

E. Parts and Materials

No.	Parts	Materials
1	Sensing element	Tin dioxide (SnO ₂)
2	Substrate	Alumina (Al ₂ O ₃)
3	Lead wire	Noble metal alloy (Au-Pd-Mo)
4	Heater	Ruthenium oxide (RuO ₂)
5	Electrode	Gold (Au)
6	Plastic housing	Nylon 46 (UL94HB)
7	Plastic base	Nylon 66 (UL94HB)
8	Stainless steel mesh	SUS 316 (100 mesh, double)
9	Heater/electrode pins	Nickel

Please contact

March 2006

FIS Inc.
3-36-3, Kitazono
Itami, Hyogo
664-0891 Japan

Tel: +81-72-780-1800
Fax: +81-72-785-0073
<http://www.fisinc.co.jp>