

# PYROELECTRIC FOUR ELEMENT DETECTORS FOR INTRUSION ALARM

PYROELECTRIC DETECTORS FOR INTRUSION ALARM ■

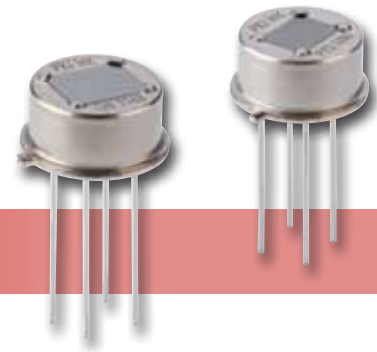

## LHi 1148, PYQ 1488 – High-End Pyro

### Applications

- Intrusion alarm
- Dual channel systems
- High-end motion sensors

### Features and Benefits

- TO-5 metal housing
- Dual channel
- Reverse / equal polarity
- RF protection option

### Product Description

The LHi 1148 series with four element “Quad” configuration offers two independent dual element signals with opposite polarity. This enables separate signal processing option for the two channels to reduce common-mode RF influence and thermal effects.

For ceiling mount applications, we offer the PYQ1488 which has the dual element pairs arranged in a diagonal geometrical arrangement. This enables presence detection without any preference of direction.

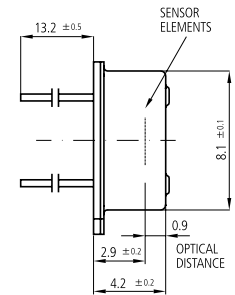
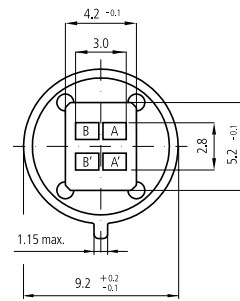
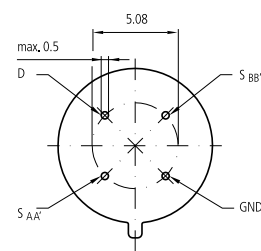
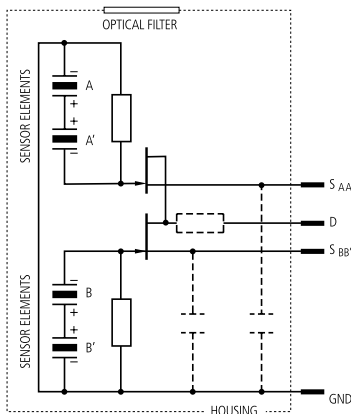

LHi 1148

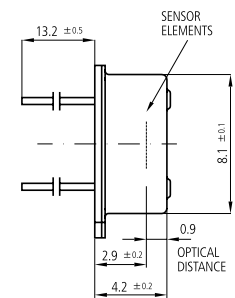
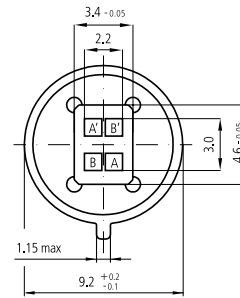
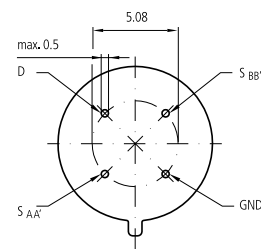

PYQ 1488

All dimensions in mm

## LHi 1148, PYQ 1488 – High-End Pyro

Parameter	Symbol	LHi 1148	PYQ 1488	Unit	Remark
Responsivity, min.	R <sub>min</sub>	4.3	6.0	kV/W	f = 1 Hz
Responsivity, typ.	R	5.9	8.0	kV/W	f = 1 Hz
Match, max.	M <sub>max</sub>	15	10	%	
Noise, max.	N <sub>max</sub>	75	100	μV <sub>pp</sub>	0.4... 10 Hz / 20° C
Noise, typ.	N <sub>typ</sub>	30	40	μV <sub>pp</sub>	0.4... 10 Hz / 20° C
Spec. detectivity	D*	16	14	10 <sup>7</sup> cm <sup>2</sup> √Hz/W	1 Hz / 1 Hz BW / 20° C
Field of view, horizontal	FoV	110°	75°		Unobstructed
Field of view, vertical	FoV	70°	58°		Unobstructed
Source voltage		0.2 - 1.5	0.2-1.5	V	47 kΩ / 20° C / 5 V
Operating voltage		2.0 ... 12	2.0 ... 12	V	47 kΩ / 20° C