

THERMOPILE DETECTORS FOR GAS SENSING

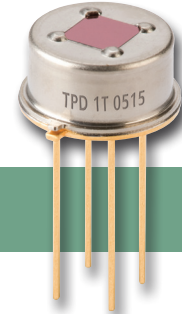

TPD 1T 0525, TPD 1T 0625 – High Sensitivity Thermopile

Applications

- Gas sensing and monitoring

Features and Benefits

- High sensitivity
- TO-5 metal housing
- Thermistor included
- Narrow band pass filters

Product Description

These two thermopile detectors are specially designed for high signal output level. They are equipped with an internal thermistor as temperature reference for thermopile temperature compensation. Both series are made in TO-5 housing with a square window. They can be obtained with either a standard IR window or with a narrow band pass filter window as per page 7 of this catalog. With the narrow band pass filters, these detectors are an excellent choice for applications of gas monitoring and detection.

Field of View

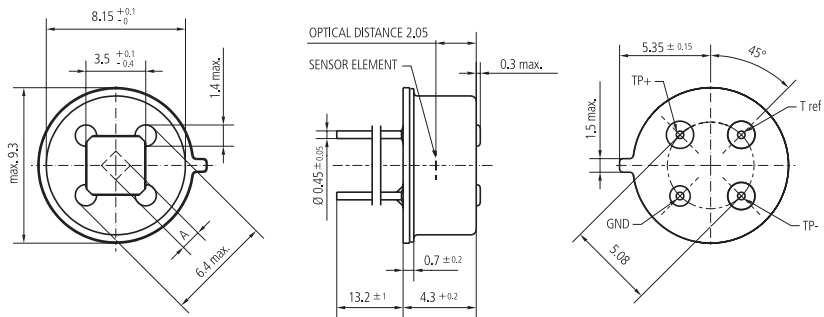
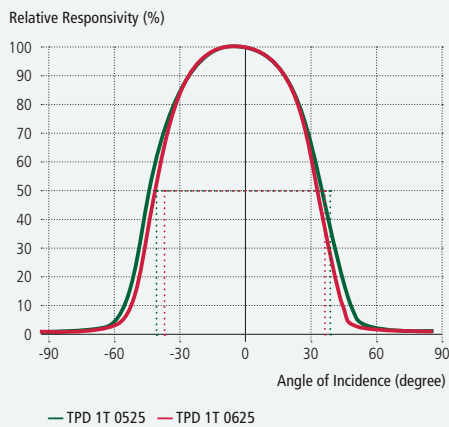

TPD 1T 0525, TPD 1T 0625 – High Sensitivity Thermopile

Parameter	Symbol	0515	0625	Unit	Remark
Sensitive area	A	1.25 x 1.25	1.2 x 1.2	mm	Absorber area
Sensitive area	A	1.6	1.4	mm ²	Absorber area
Thermopile resistance	R _{TP}	25 ... 70	50 ... 110	kΩ	25° C
Responsivity	R	28	33	V/W	500° / 1Hz/ without IR-filter
Time constant	t	35	27	ms	
Noise voltage	V _N	29	36	nV / √Hz	25° C
Specific detectivity	D*	1.2	1.1	10 ⁸ cm ² /Hz / W	25° C
Temp. coefficient of resistance	TC _{RTP}	0.03	0.03	% / K	
Temp. coefficient of responsivity	TC _R	-0.05	-0.05	% / K	
Field of view	FoV	80	76	Degrees	At 50% intensity points
Thermistor resistance (25° C)	R ₂₅	100	100	kΩ	25° C
Thermistor BETA-value	β	3964	3964	K	Defined at 25° C / 100° C