

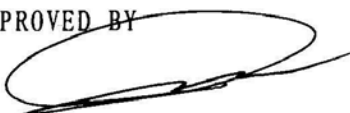

SPECIFICATION
OF
PYROELECTRIC PASSIVE
INFRARED SENSOR

MODEL NO. SR-4N-P

PART NO. _____

Agent: Hi-Rel (Hong Kong)

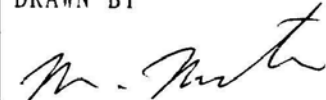
PYROELECTRIC PASSIVE INFRARED SENSOR MODEL NO. SR-4N-P	PAGE 1 / 6	DRAWING NO. 1707982	REV : A
	NIPPON CERAMIC CO., LTD.		
APPROVED BY 	CHECKED BY 	DRAWN BY 	

SCOPE

THIS SPECIFICATION DESCRIBES A PYROELECTRIC PASSIVE INFRARED SENSOR SUPPLIED BY NIPPON CERAMIC CO.,LTD.

TYPE OF SENSOR

BALANCED DIFFERENTIAL (SERIES OPPOSED TYPE.)

PHYSICAL CONFIGURATION

- 1) PACKAGE : TO-5 METAL CAN WITH DIMENSIONS SHOWN IN FIGURE 1-C (NICKEL-PLATED)
- 2) ELEMENT GEOMETRY : TWO SENSITIVE AREAS 2.0 mm LONG, 1.0 mm WIDE AND SPACED 1.0 mm APART.
- 3) ELEMENT ORIENTATION : SEE FIGURE 1-B
- 4) LEAD CONFIGURATION : SEE FIGURE 1-C, 1-D

ELECTRICAL CHARACTERISTICS (AT 25 ± 5 °C)

- 1) CIRCUIT CONFIGURATION : THREE-TERMINAL SENSOR WITH SOURCE FOLLOWER SEE FIGURE 2
- 2) OPERATING VOLTAGE : 3 ~ 10 V DC (Rs: 47KΩ)
- 3) SOURCE VOLTAGE : 0.3 ~ 1.5 V (VD: 5V, Rs: 47KΩ)
- 4) SIGNAL OUTPUT : MIN. 2.5 Vp-p (TYP. 4.0 Vp-p)

SIGNAL OUTPUT IS MEASURED AT CHOPPER FREQUENCY OF 1 Hz WHEN CONNECTED TO THE AMPLIFIER OF GAIN 72.5 dB (AT 1 Hz) AND SUBMITTED TO THE EMISSION OF INFRARED ENERGY OF 13 μW/cm² FROM 420 K BLACK BODY.
SEE FIGURE 3

- 5) NOISE OUTPUT : MAX. 250 mVp-p (TYP. 90 mVp-p)

NOISE OUTPUT SHALL BE MEASURED FOR 20 SECONDS WHEN CONNECTED TO THE AMPLIFIER OF GAIN 72.5 dB AND SHUT OUT FROM INFRARED ENERGY.
SEE FIGURE 3

MODEL NO. : SR-4N-P	PAGE	DRAWING NO.	REV :
	2 / 6	1707982	A
PART NO. :	 NIPPON CERAMIC CO., LTD.		

6) BALANCE OUTPUT : MAX. 15 %

$$[BO / | SA+SB |] \leq 0.15$$

BO : BALANCE OUTPUT

SA : SIGNAL OUTPUT ON ELEMENT A

SB : SIGNAL OUTPUT ON ELEMENT B

BALANCE OUTPUT IS MEASURED AT CHOPPER FREQUENCY OF 1 Hz WHEN CONNECTED TO THE AMPLIFIER OF GAIN 72.5 dB (AT 1 Hz) AND SUBMITTED TO THE EMISSION OF INFRARED ENERGY OF $13 \mu W/cm^2$ FROM 420 K BLACK BODY.
SEE FIGURE 3

7) FREQUENCY RESPONSE : 0.3 Hz TO 3.0 Hz / ± 10 dB

OPTICAL CHARACTERISTICS

- 1) FIELD OF VIEW : 138° FROM CENTER OF ELEMENT ON AXIS X
: 125° FROM CENTER OF ELEMENT ON AXIS Y
: SEE FIGURE 1-A
- 2) FILTER SUBSTRATE : SILICON
- 3) CUT ON (5 %T ABS) : $5.0 \pm 0.5 \mu m$
- 4) TRANSMISSION : ≥ 70 % AVERAGE 7~14 μm

ENVIRONMENTAL REQUIREMENTS

- 1) OPERATING TEMPERATURE : -30 °C TO +70 °C
- 2) STORAGE TEMPERATURE : -40 °C TO +80 °C
- 3) RELATIVE HUMIDITY :
THE SENSOR SHALL OPERATE WITHOUT INCREASE IN NOISE OUTPUT WHEN EXPOSED TO 90 ~ 95 % RH AT 30 °C CONTINUOUSLY.
- 4) HERMETIC SEAL :
THE SENSOR SHALL BE SEALED TO WITHSTAND A VACUUM OF .160 MILLIMETERS OF MERCURY.

MODEL NO. : SR-4N-P

PAGE
3 / 6

DRAWING NO.
1707982

REV :
A

PART NO. :

© NIPPON CERAMIC CO., LTD.

CONFIGURATION (FIGURE 1)

**FIELD OF VIEW
(FIGURE 1-A)**

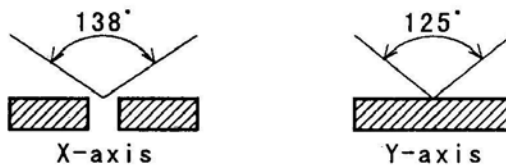

**TOP VIEW
(FIGURE 1-B)**

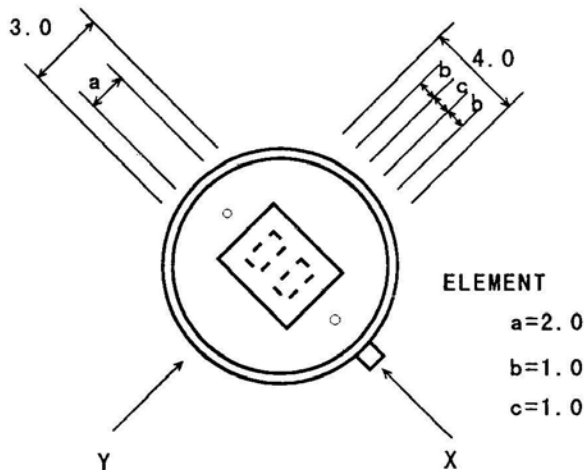

**SIDE VIEW
(FIGURE 1-C)**

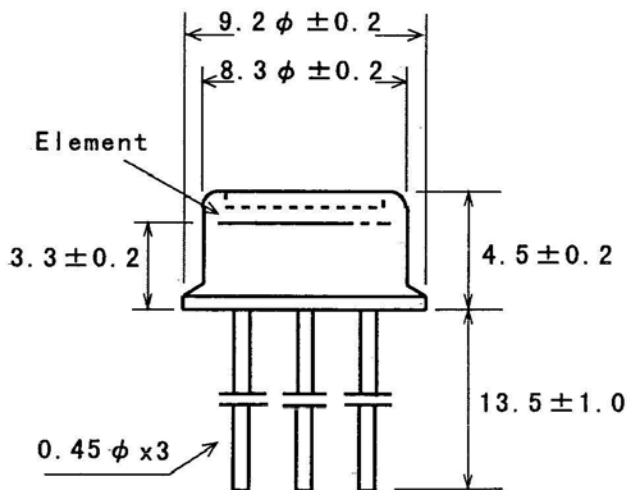

**BASE VIEW
(FIGURE 1-D)**

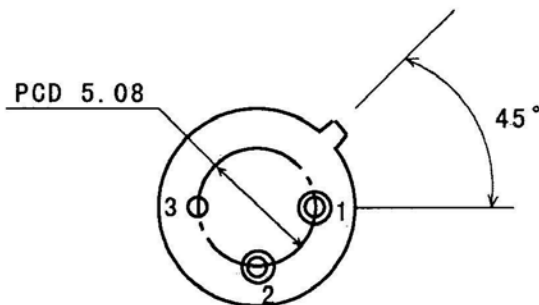

- 1: DRAIN
- 2: SOURCE
- 3: GROUND

UNIT : mm

MODEL NO. : SR-4N-P	PAGE	DRAWING NO.	REV :
	4 / 6	1707982	A
PART NO. :	NIPPON CERAMIC CO., LTD.		

CIRCUIT CONFIGURATION (FIGURE 2)

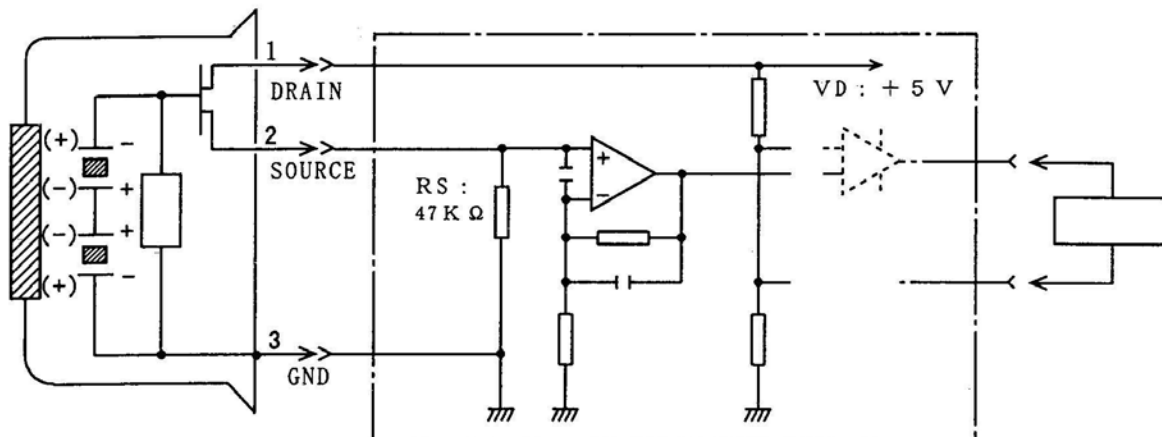

SENSOR

MEASUREMENT AMP.

RECORDER

※ MEASUREMENT AMP.: NON-INVERTED TYPE, GAIN 72.5 dB AT 1 Hz 0.4~2.7 Hz / -3 dB

TEST SET-UP BLOCK DIAGRAM (FIGURE 3)

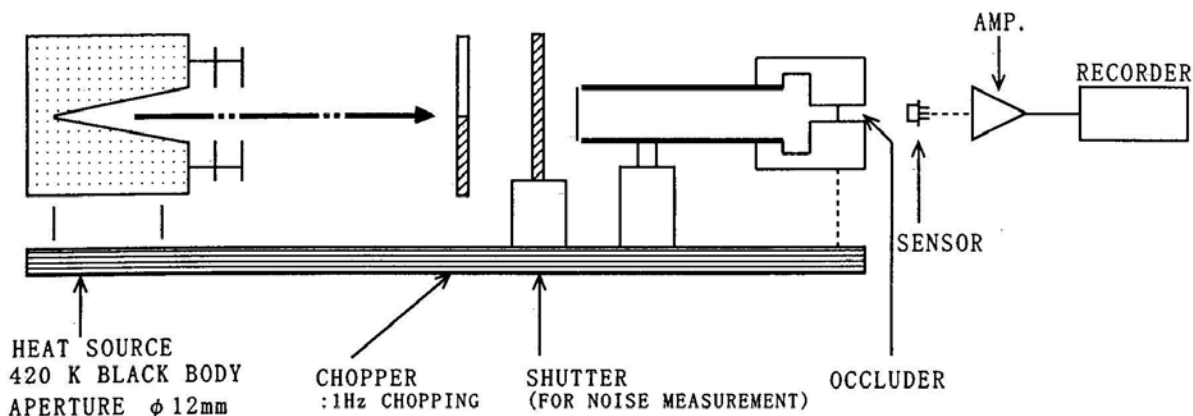

HEAT SOURCE
420 K BLACK BODY
APERTURE ϕ 12mm

CHOPPER
:1Hz CHOPPING

SHUTTER
(FOR NOISE MEASUREMENT)

OCCLUDER

AMP.
RECORDER

SENSOR

OCCLUDER POSITION

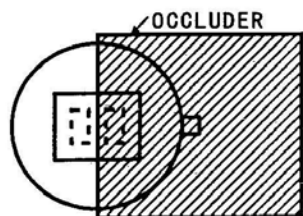

SIGNAL OUTPUT

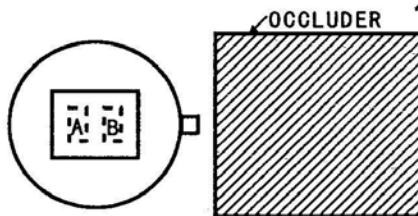

BALANCE OUTPUT

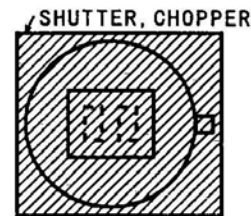

NOISE OUTPUT

MODEL NO. : SR-4N-P

PART NO. :

PAGE
5 / 6

DRAWING NO.
1707982

REV :
A

© NIPPON CERAMIC CO., LTD.

※ NOTES

1. DESIGN RESTRICTIONS/PRECAUTIONS

FOR OUTDOOR APPLICATIONS, BE SURE TO APPLY SUITABLE SUPPLEMENTARY OPTICAL FILTER AND DRIP-PROOF, ANTI-DEW CONSTRUCTION. THIS SENSOR IS DESIGNED FOR INDOOR USE. IN CASES WHERE SECONDARY ACCIDENTS DUE TO OPERATION FAILURE OR MALFUNCTIONS CAN BE ANTICIPATED, ADD A FAIL SAFE FUNCTION TO THE DESIGN.

2. USAGE RESTRICTIONS/PRECAUTIONS

TO PREVENT SENSOR MALFUNCTIONS, OPERATIONAL FAILURE OR ANY DETERIORATION OF ITS CHARACTERISTICS, DO NOT USE THIS SENSOR IN THE FOLLOWING, OR SIMILAR, CONDITIONS.

- A. IN RAPID ENVIRONMENTAL TEMPERATURE CHANGES.
- B. IN STRONG SHOCK OR VIBRATION.
- C. IN A PLACE WHERE THERE ARE OBSTRUCTING MATERIALS (GLASS, FOG, ETC.) THROUGH WHICH INFRARED RAYS CANNOT PASS WITHIN DETECTION AREA.
- D. IN FLUID, CORROSIVE GASES AND SEA BREEZE.
- E. CONTINUAL USE IN HIGH HUMIDITY ATMOSPHERE.
- F. EXPOSED TO DIRECT SUN LIGHT OR HEADLIGHTS OF AUTOMOBILES.
- G. EXPOSED TO DIRECT WIND FROM A HEATER OR AIR CONDITIONER.

3. ASSEMBLY RESTRICTIONS/PRECAUTIONS

SOLDERING -----

- A. USE SOLDERING IRONS WHEN SOLDERING.
- B. AVOID KEEPING PINS OF THIS SENSOR HOT FOR A LONG TIME AS EXCESSIVE HEAT MAY CAUSE DETERIORATION OF ITS QUALITY. (E.G. WITHIN 5 SEC. AT 350 °C)

WASHING -----

- A. BE SURE TO WASH OUT ALL FLUX AFTER SOLDERING AS REMAINDER MAY CAUSE MALFUNCTIONS.
- B. USE A BRUSH WHEN WASHING. WASHING WITH AN ULTRASONIC CLEANER MAY CAUSE OPERATIONAL FAILURE.

4. HANDLING AND STORAGE RESTRICTIONS/PRECAUTIONS

TO PREVENT SENSOR MALFUNCTIONS, OPERATIONAL FAILURE, APPEARANCE DAMAGE OR ANY DETERIORATION OF ITS CHARACTERISTICS, DO NOT EXPOSE THIS SENSOR TO THE FOLLOWING OR SIMILAR, HANDLING AND STORAGE CONDITIONS.

- A. VIBRATION FOR A LONG TIME.
- B. STRONG SHOCK.
- C. STATIC ELECTRICITY OR STRONG ELECTROMAGNETIC WAVES.
- D. HIGH TEMPERATURE AND HUMIDITY FOR A LONG TIME.
- E. CORROSIVE GASES OR SEA BREEZE.
- F. DIRTY AND DUSTY ENVIRONMENTS THAT MAY CONTAMINATE THE OPTICAL WINDOW.

SENSOR TROUBLES RESULTING FROM MISUSE, INAPPROPRIATE HANDLING OR STORAGE ARE NOT THE MANUFACTURER'S RESPONSIBILITY.

MODEL NO. : SR-4N-P	PAGE	DRAWING NO.	REV :
	6 / 6	1707982	A
PART NO. :	 NIPPON CERAMIC CO., LTD.		