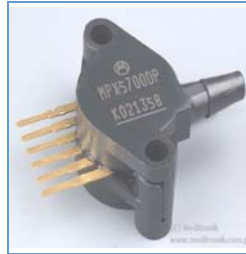


美国 MOTOROLA 压力传感器

美国 MOTOROLA 公司的 MPX 系列硅压力传感器，主要以气压测量为主，适合用于医疗器械，气体压力控制等领域，输出数字信号。其测量方式可分为：表压 (GP)、绝压 (A、AP)、差压 (D、DP) 型。在宽温度范围工作时需外加补偿网络和信号调整电路。具体型号分类而定



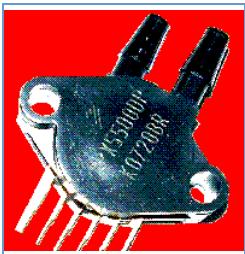
名称: MPX2010DP



名称: MPX5700DP MPX5700GP



名称: MPX2100AP



名称: MPX5500DP



名称: MPX5100AP



名称: MPX5050DP



名称: MPX5010DP



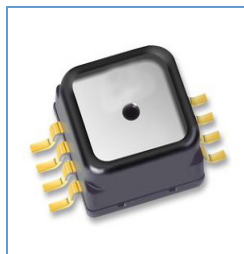
名称: MPX4115AP



名称: MPX2200A



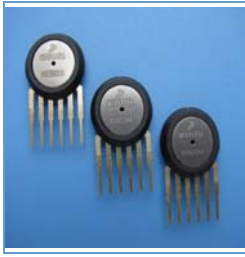
名称: MPX2200AP



名称: MPXH6115A6U



名称: MPX4250DP



名称: MPX4115A



名称: MPX2202DP



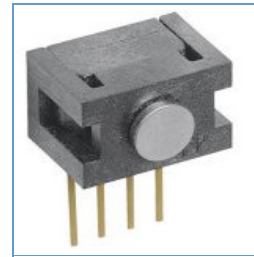
名称: MPX2102AP



名称: MPX2053GP



名称: MPXY8300A6U 压力传感器



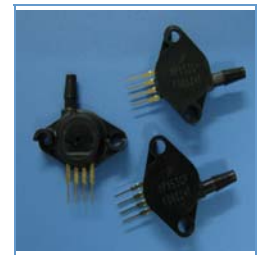
名称: 触力型压力传感器 FSG15N1A



名称: 硅压力传感器 MPXH6115A



名称: MPX5700DP 硅压力传感器



名称: MPX53GP 硅压力传感器



名称: 压力传感器 FPM07



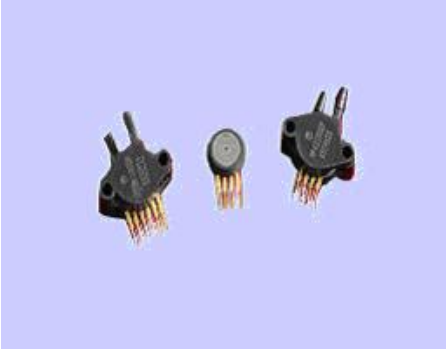
名称: 轮胎压力传感器 TP015




名称: 轮胎压力传感器 NPP301




名称: Freescale 压力传感器 MPX2010DP



**SMALL OUTLINE PACKAGE**



MPXV10GC6U  
CASE 482A




MPXV10GC7U  
CASE 482C

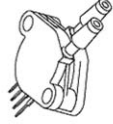
PIN NUMBER			
1	Gnd	5	N/C
2	+V <sub>out</sub>	6	N/C
3	V <sub>s</sub>	7	N/C
4	-V <sub>out</sub>	8	N/C

NOTE: Pin 1 is noted by the notch in the lead.

**UNIBODY PACKAGE**



MPX10D  
CASE 344



MPX10DP  
CASE 344C

PIN NUMBER			
1	Gnd	3	V <sub>e</sub>
2	+V <sub>out</sub>	4	-V <sub>out</sub>

NOTE: Pin 1 is noted by the notch in the lead.

商斯达实业传感器与智能控制分公司专门从事各种进口传感器的营销工作，代理多家欧美知名公司的产品。涉及压力、温度、湿度、电流、液位、磁阻、霍尔、流量、称重、光纤、倾角、扭矩、气体、光电、位移、触力、红外、速度、加速度等多种产品。广泛应用于航空航天、医疗器械（如血压计）、工业控制、冶金化工、汽车制造、教育科研等领域。

商斯达实业代理的品牌产品主要有：

压 力: Kulite、ACSI、Honeywell、Entran、Gems、Dwyer、SSI、Smi、Senstronics、Intersema、Motorola、NAIS、E+H、Fujikura、Dytran、APM

称重测力: Transcell、HBM、Interface、Thamesside、Philips、Entran

温 湿 度: Honeywell、Dwyer

流 量: Gems、Dwyer、Honeywell、Folwline、WorldMagnetics

液 位: Honeywell、Sicom、Gems、Dwyer、Kulite、SSI

加 速 度: Entran、Silicondesigns、Dytran

压力开关: ACSI、Gems、Dwyer、台湾矽微

航空器材: TexTech 隔音材料、Honeywell 薄膜加热片、DigirayX 射线探伤仪

仪 表: Honeywell、Transcell、东辉、上润、AD、东崎

商斯达实业 除代理上述产品外，还有几条传感器生产线，一条压力传感器组装线，可为用户提供各种用途的、特殊要求的配套产品。同时还和国内众多同行建立了友好交流的合作关系。商斯达实业地处深圳，信息资源集中，技术力量雄厚，与国内外有着广泛的联系，本着互利互惠、让利与长期合作者的原则，以成为企业“理想的战略伙伴”为己任，深受业界好评。商斯达实业期待着与您开展更友好、更广泛、更深入的合作！

MMA7260Q 是一款三轴 (XYZ-Axis) 向低重力加速度传感器, 提供 1.5g、2g、4g 和 6g 的可选灵敏度。MMA7260Q 能够用于各种多功能应用, 具备感应坠落、倾斜、移动、定位、撞击和震动的功能。它的封装尺寸很小, 只需较小的板卡空间, 另外还提供快速启动和休眠模式, 这些特性使 MMA7260Q 成为采用电池供电的电子产品的理想之选, 包括 PDA、手机、3D 游戏和数码相机等。 更多

## 重点汽车应用

轮胎压力监控系统 (中文)

轮胎压力监控系统 (TPMS) 在线座谈 (中文)

## 重点产品

加速度 (Low-g) 传感器

MMA7260Q 低重力加速度 (low-g) 传感器 (中文)

MMA6200xxQ 低重力加速度 (low-g) 传感器 (中文)

集成压力传感器

MPXAZ 或 MPXHZ 封装的集成压力传感器特别适用于**汽车应用**

MPXA6115A 高温精确集成压力传感器 (中文)

MPXAZ6115A 媒体耐抗的高温精确集成压力传感器 (中文)

MPXH6115A 高温精确集成压力传感器 (中文)

MP3H6115A 高温精确集成压力传感器 (中文)

MPXHZ6115A 媒体耐抗的高温精确集成压力传感器 (中文)

MPXH6250A 集成压力传感器 (中文)

MPXH6300A 压力传感器 (中文)

MPXH6400A 集成压力传感器 (中文)

美国 motorola/freescale 气压传感器

MPX10D MPX10DP MPX10GP MPX10GS MPXV10GC6U MPXV10GC7U MPX12D MPX12DP MPX12GP MPX2010D MPX2010DP MPX2010GP MPXT2010G7U MPX2050D MPX2050DP MPX2050GP MPX2050GVP MPX2050GS MPX2050GSX MPX2050GVSX MPX2053D MPX2053DP MPX2053GP MPX2100A MPX2100DP MPX2100AP MPX2100AS MPX2100ASX MPX2102A MPX2102D MPX2102DP MPX2102AP MPX2102GP MPX2102GVP MPX2200A MPX2200D MPX2200DP MPX2200AP MPX2200GP MPX2200A MPX2200D MPX2200DP MP2200AP MPX2200GP MPX21002A MPX2102D MPX2102DP MPX2102AP MPX2102GP MPX2102GVP MPX2200A MPX2200D MPX2200DP MPX2200AP MPX2200GP MPX2201GP MPX2300DT1 MPX4080D MPX4100A MPXA4100A6U MPX4100AP MPXA4100A6U MPX4100AS MPX4101A MPXA4101AC6U MPX4105A MPX4115A MPXA4115A6U MPX4115AP MPXA4115AC6U MPX4115AS MPX4200A MPX4200AP MPX4200SA MPX4200ASX MPX4250A MPX4250AP MPX4250A6U MPXA4250A6T1 MPXA4250AC6U MPXA4250AC6T1 MPX4250D MPX4250GP MPX4250DP MPX5010D MPX5010DP MPX5010GP MPX5010GS MPX5010GSX MPXV5010G6U MPXV5010G7U MPXV5010GC6U/T1 MPXV5010GC7U MPX5050D MPX5050DP MPX5050GP MPX5100A MPX5100D MPX5100DP MPX5100AP MPX5100GP MPX5100GVP MPX5100AS MPX5100GS MPX5100GVS MPX5100ASX MPX5100GSX MPX5100GVSX MPX53D MPX53GP MPX5500D MPX5500DP MPX5700D MPX5700A MPX5700DP MPX5700GP MPX5700AP MPX5700GS MPX5700AS MPX5999D MPXA6115A6U MPXA6115AC6U MPXA6115A MPXA6115A6T1 MPXA6115AC6T1 MPXAZ4100A6U MPXAZ4100A MPXAZ4100A6T1 MPXAZ4100AC6U MPXA4115A6U MPXZ4115A MPXAZ4115A6T1 MPXAX4115AC6U MPXAZ4115AC6T1 MPXC2011DT1 MPXM2010D MPXM2010DT1 MPXM2010GS MPXM2010GST1 MPXM2053D MPXM2053DT1 MPXM2053GS MPXM2053GST1 MPXV4006GC6U MPXV4006G6U MPXV4115V6U MPXV4115V6T1 MPXV4115VC6U MPXV5004GC6U/T1 MPXV5004G6U/T1 MPXV5004GC7U MPXV5004G7U MPXY8010 MPXY8020 MPXY8030 MPXY8040 MMA6200xxQ

低重力加速度 (low-g) 传感器

MPXA6115A 高温精确集成压力传感器 MPXAZ6115A 耐抗高温压力传感器 MPXH6115A 高温精确集成压力传感器

MP3H6115A 高温精确集成压力传感器 MPXHZ6115A 媒体耐抗的高温精确集成压力传感器 MPXH6250A 集成压力传感器 MPXH6300A 压力传感器

MPXH6400A 集成压力传感器 等汽车用压力传感器

详情请致电我公司或上我公司网站查询

美国 motorola 压力传感器

MPX2010 MPX2100 MPX4080D MPX5050 MPX4105A MPX4200

MPX4250D MPX2050 MPX5999D MPX5100 MPX5010 MPX10

MPX4115A MPX4250A

MPX（毫伏输出）选型指南：（D：差压、A：绝压、P：含包装、MPX7000 系列适合电池供电）

型号	压力范围 KPa	满量程输出, mV			灵敏度 mV/psi	过压 psi, Max	价格<元>	详细资料
		Min.	Typ.	Max.				
MPX10D/DP	10	20	35	50	3.5	75		查看
MPX50D/DP	50	45	60	90	1.2	200		查看
MPX100D/DP/A/AP	100	45	60	90	0.6	200		查看
MPX200D/DP/A/AP	200	45	60	90	0.3	400		查看
MPX700D/DP	700	45	60	90	0.086	2800		查看
MPX2010D/DP	10	24	25	26	2.5	700		查看
MPX2050D/DP	50	38.5	40	41.5	0.8	200		查看
MPX2100D/DP/A/AP	100	38.5	40	41.5	0.4	400		查看
MPX2200D/DP/A/AP	200	38.5	40	41.5	0.2	400		查看
MPX2700D	700	38.5	40	41.5	0.057	2800		查看
MPX7050D/DP	50	38.5	40	41.5	0.8	200		查看
MPX7100D/DP/A/AP	100	38.5	40	41.5	0.4	400		查看
MPX7200D/DP/A/AP	200	38.5	40	41.5	0.2	400		查看

MPX（标准输出）选型指南

MPX4100A/AP	15-102	4618	4700	4782	54	400		查看
MPX4250A	20-250	4622	4690	4762	20	400		查看
MPX5010D/DP	10	4275	4500	4725	450	75		查看
MPX5050D/DP	50	4388	4500	4613	90	200		查看
MPX5100D/DP	100	4388	4500	4613	45	400		查看
MPX5100A/AP	15-115	4388	4500	4613	45	400		查看
MPX5500D/DP	500	4388	4500	4613	9.0	3500		查看
MPX5700D/DP	700	4388	4500	4613	6.0	2800		查看
MPX5999D/DP	1000	4388	4500	4613	5.0	2800		查看

*Freescale* 加速度传感器 (low g)

型号	Acceleration(g)	sensing axis	sensitivity(mg/v)	Rolloff frequency(hz)	vdd(v)	zero g output	package
MMA6260Q	1.5/1.5	X-Y	800/800	50	3.3	1.65	16pin QFN
MMA6261Q	1.5/1.5	X-Y	800/800	300	3.3	1.65	16pin QFN
MMA6262Q	1.5/1.5	X-Y	800/800	150	3.3	1.65	16pin QFN
MMA6263Q	1.5/1.5	X-Y	800/800	900	3.3	1.65	16pin QFN
MMA2260D	1.5	X	1200	50	5.0	2.5	16pin SOIC
MMA1260D	1.5	Z	1200	50	5.0	2.5	16pin SOIC
MMA1270D	2.5	Z	750	50	5.0	2.5	16pin SOIC
MMA1250D	5.0	Z	400	50	5.0	2.5	16pin SOIC
MMA1220D	8.0	Z	250	250	5.0	2.5	16pin SOIC
MMA6231Q	10/10	X-Y	120/120	300	3.3	1.65	16pin QFN
MMA6233Q	10/10	X-Y	120/120	900	3.3	1.65	16pin QFN

*Freescale* 加速度传感器 (Medium g)

型号	Acceleration(g)	sensing axis	sensitivity(mg/v)	Rolloff frequency(hz)	vdd(v)	zero g output	package
MMA3201D	40/40	X-Y	50/50	400	5.0	2.5	20pin SOIC
MMA2201D	40	X	50	400	5.0	2.5	16pin SOIC
MMA2202D	50	X	40	400	5.0	2.5	16pin SOIC
MMA3222D	50/30	X-Y	40/66.67	400	5.0	2.5	20pin SOIC
MMA3204D	100/30	X-Y	20/66.67	400	5.0	2.5	20pin SOIC
MMA3202D	100/50	X-Y	50/100	400	5.0	2.5	20pin SOIC
MMA2204D	100	X	20	400	5.0	2.5	16pin SOIC
MMA1213D	50	Z	40	400	5.0	2.5	16pin SOIC
MMA1210D	100	Z	20	400	5.0	2.5	16pin SOIC

*Freescale* 加速度传感器 (High g)

型号	Acceleration(g)	sensing axis	sensitivity(mg/v)	Rolloff frequency(hz)	vdd(v)	zero g output	package
MMA1211D	150	Z	13	400	5.0	2.5	16pin SOIC
MMA2301D	200	X	10	400	5.0	2.5	16pin SOIC
MMA1212D	200	Z	10	400	5.0	2.5	16pin SOIC
MMA2300D	250	X	8.0	400	5.0	2.5	16pin SOIC
MMA1200D	250	Z	8.0	400	5.0	2.5	16pin SOIC

*Freescale* 集成压力传感器

型号	最大压力	最大压力	最大压力	最大压力	最大压力	过压 (kpa)	量程 电压	灵敏 mV/Kpa	精度 0~85 (% of VFSS)	典型压力			
	psi	kpa	in H2O	cm H2O	mm Hg		vdc			A	D	G	V
MPX4080	11.6	80	321	815	600	400	4.3	54	±3.0		•		
MPX4100	15.2	105	422	1070	788	400	4.6	54	±1.8	•			
MPX4101	14.8	102	410	1040	765	400	4.6	54	±1.8	•			
MPXA6115A	16.7	115	462	1150	863	400	4.5	45.9	±1.5	•			
MPX4105	15.2	105	422	1070	788	400	4.6	51	±1.8	•			
MPX4115	16.7	115	462	1174	863	400	4.6	46	±1.5	•			
	16.7	115	462	1174	863	400	4.0	38	±1.5				•
MPXH6115A	16.7	115	462	1150	863	400	4.6	45.9	±1.5	•			
MPX4200	29	200	803	2040	1500	400	4.5	26	±1.5	•			
MPX4250	36	250	1000	2550	1880	400	4.7	20	±1.5	•			
	36	250	1000	2550	1880	400	4.7	19	±1.4		•	•	
MPXH6250	36	250	1000	2550	1880	400	4.7	19	±1.5	•			
MPXV4006	0.87	6.0	24	61	45	10	4.6	766	±5.0		•		•
MPXV5004	0.57	4.0	16	40	29	10	3.9	1000	±2.5		•		•
MPX5010	1.45	10	40	102	75	75	4.5	450	±5.0		•		•
MPX5050	7.25	50	201	510	375	200	4.5	90	±2.5		•	•	•
MPX5100	14.5	100	401	1020	750	400	4.5	45	±2.5		•	•	
	16.7	115	462	1174	863	400	4.5	45	±2.5	•			
MPX5500	72.5	500	2000	5100	3750	2000	4.5	9.0	±2.5		•	•	
MPX5700	102	700	2810	7140	5250	2800	4.5	6.0	±2.5	•	•	•	
MPX5999	150	1000	4150	10546	7757	4000	4.5	5.0	±2.5		•		
MPXh6300	44	300	1200	3060	2250	400	4.7	16	±1.8	•			
MPXH6400	60	400	1600	4000	3000	500	4.7	12	±1.5	•			

Freescale 带补偿压力传感器

型号	最大压力	最大压力	最大压力	最大压力	最大压力	过压 (kpa)	零位偏差 mv	量程电压 mv	灵敏 mV/Kpa	线性%量程 最小	线性%量程 最大	典型压力			
	psi	kpa	in H2O	cm H2O	mm Hg							A	D	G	V
MPX2010	1.45	10	40	102	75	75	±1.0	25	2.5	-1.0	1.0		•	•	
MPX2053	7.0	50	201	510	375	200	±1.0	40	0.8	-0.6	0.4		•		•
MPX2102	14.5	100	400	1020	750	200 200	±2.0 ±	40	0.4	-1.0	1.0	•	•		•
	14.5	100	400		750		1.0	40	0.4	-0.6	0.4				

MPX2202	29	200	800	2040	1500	400 400	±1.0 ±	40	0.2	-1.0	1.0	•	•	•
	29	200	800		1500		1.0	40	0.2	-0.6	0.4			
MPX2050	7.0	50	201	510	375	200	±1.0	40	0.8	-0.3	-0.3		•	•
MPX2100	14.5	100	400	1020	750	200 200	±2.0 ±	40	0.4	-1.0	-1.0	•	•	•
	14.5	100	400		750		1.0	40	0.4	-0.3	-0.3			
MPX2200	29	200	800	2040	1500	400 400	±1.0 ±	40	0.2	-1.0	-1.0	•	•	•
	29	200	800		1500		1.0	40	0.2	-0.3	-0.3			

*Freescale* 无补偿压力传感器

型号	最大压力	最大压力	最大压力	最大压力	最大压力	过压 (kpa)	零位偏差 mv	量程电压 mv	灵敏 mV/Kpa	线性 %	线性 %	典型压力			
	psi	kpa	in h2o	cm h2o	mm Hg					量程 最 小	量程 最 大	A	D	G	V
MPX10	1.45	10	40	102	75	75	20	35	3.5	-1.0	1.0		•	•	
MPX12	1.45	10	40	102	75	75	20	55	3.5	-1.0	1.0		•	•	
MPX53	7.0	50	200	510	375	200	20	60	1.2	-0.6	0.4		•	•	

*Freescale* 胎压监测传感器

型号	最大压力	最大压力	最大压力	量程 输出	灵敏 kpa/count	最大压力 精度	最大压力 精度	最大温度 精度	工作电压 v	典型压力				
	psi	kpa	BAR			-20° C	+25 ° C-+70° C			+25° C	A	D	G	V
MPXY8020A	92.4	637.5	6.4	8-BIT	2.5	±15kpa	±7.5kpa	±4° C	2.1-3.6		•			
MPXY8021A	92.4	637.5	6.4	8-BIT	2.5	±20kpa	±7.5kpa	±4° C	2.1-3.6	•				
MPXY8040A	130.5	900	9.0	8-BIT	5.0	±25kpa	±20kpa	±4° C	2.1-3.6	•				

单位换算

单位	千帕	mm Hg	millibars	inchesH2O	PSI
1 大气压	101.325	760.00	1013.25	406.795	14.696



1 千帕	1.00000	7.50062	10.0000	4.01475	0.145038
1 mm Hg	0.133322	1.00000	1.33322	0.535257	0.0193368
1 millibar	0.100000	0.750062	1.00000	0.401475	0.0145038
1 inch H2o	0.249081	1.86826	2.49081	1.00000	0.0361
1 PSI	6.89473	51.7148	68.9473	27.6807	1.00000
1 hectoPascal	0.100000	0.75006	1.00000	0.401475	0.0145038
1 cm H2O	0.09806	0.7355	9.8x10*7	0.3937	0.014223

压力传感器型号解析(MPX2XXXAPXT1)

M	PX	A	2	XXX	A	P	X	T1
M - 标准品	压	无 -UNIBODY AH- SSOP A/V- SOP AZ -SMALL OUTLINE MEDIA RESISTANT PACKAGE	无-无补偿 2-温度补偿校正 3-open	最大压力 (kpa) mpx2300 (mmHg)	A-绝对压力 G-表压 D-差压 V-真空	C-AXI XL PORT (SMALL OUTLINE PACKAGE) P-PORTED SINGLE PORT (AP, GP, GVP) DUAL PORT (DP) S-STOVEPIPE PORT (UNIBODY) SX-AXIAL PORT (UNIBODY)	NONE-NO LEADFORM 0-OPEN 1-2 (CONSULT FACTORY) 3-5 OPEN 6-7 SOP ONLY (6=GULL WING/SURFACE MOUNT) (7= 87 DEGREES/DIP)	NONE-TRAYS T1-TAPE AND REEL 1 INDICATES PART ORIENTATION IN TAPE U-RAIL
S-定制品	力	C-CHIP HZ-SUPER SMALL OUTLINE MEDIA RESISTANT	4-温度补偿校正信号 自动校准					
感	器	M-M PAK Y-SUPER SMALL OUTLINE PACKAGE (TPM)	5- 温度补偿校正信号 6-高温 7-CMOS 8-胎压检测					
P, X-测试品								

SUNSTAR商斯达实业集团是集研发、生产、工程、销售、代理经销、技术咨询、信息服务等为一体的高科技企业，是专业高科技电子产品生产厂家，是具有10多年历史的专业电子元器件供应商，是中国最早和最大的仓储式连锁规模经营大型综合电子零部件代理分销商之一，是一家专业代理和分销世界各大品牌IC芯片和电子元器件的连锁经营综合性国际公司。在香港、北京、深圳、上海、西安、成都等全国主要电子市场设有直属分公司和产品展示展销窗口门市部专卖店及代理分销商，已在全国范围内建成强大统一的供货和代理分销网络。我们专业代理经销、开发生产电子元器件、集成电路、传感器、微波光电元器件、工控机/DOC/DOM电子盘、专用电路、单片机开发、MCU/DSP/ARM/FPGA软件硬件、二极管、三极管、模块等，是您可靠的一站式现货配套供应商、方案提供商、部件功能模块开发配套商。专业以现代信息产业（计算机、通讯及传感器）三大支柱之一的传感器为主营业务，专业经营各类传感器的代理、销售生产、网络信息、科技图书资料及配套产品设计、工程开发。我们的专业网站——中国传感器科技信息网（全球传感器数据库）[www.SENSOR-IC.COM](http://www.SENSOR-IC.COM) 服务于全球高科技生产商及贸易商，为企业科技产品开发提供技术交流平台。欢迎各厂商互通有无、交换信息、交换链接、发布寻求代理信息。欢迎国外高科技传感器、变送器、执行器、自动控制产品厂商介绍产品到中国，共同开拓市场。本网站是关于各种传感器-变送器-仪器仪表及工业自动化大型专业网站，深入到工业控制、系统工程计 测量、自动化、安防报警、消费电子等众多领域，把最新的传感器-变送器-仪器仪表买卖信息，最新技术供求，最新采购商，行业动态，发展方向，最新的技术应用和市场资讯及时的传递给广大科技开发、科学研究、产品设计人员。本网站已成功为石油、化工、电力、医药、生物、航空、航天、国防、能源、冶金、电子、工业、农业、交通、汽车、矿山、煤炭、纺织、信息、通信、IT、安防、环保、印刷、科研、气象、仪器仪表等领域从事科学研究、产品设计、开发、生产制造的科技人员、管理人员、和采购人员提供满意服务。我公司专业生产、代理、经销、销售各种传感器、变送器、敏感元器件、开关、执行器、仪器仪表、自动化控制系统：专门从事设计、生产、销售各种传感器、变送器、各种测控仪表、热工仪表、现场控制器、计算机控制系统、数据采集系统、各类环境监控系统、专用控制系统应用软件以及嵌入式系统开发及应用等工作。如热敏电阻、压敏电阻、温度传感器、温度变送器、湿度传感器、湿度变送器、气体传感器、气体变送器、压力传感器、压力变送、称重传感器、物（液）位传感器、物（液）位变送器、流量传感器、流量变送器、电流（压）传感器、溶氧传感器、霍尔传感器、图像传感器、超声波传感器、位移传感器、速度传感器、加速度传感器、扭距传感器、红外传感器、紫外传感器、火焰传感器、激光传感器、振动传感器、轴角传感器、光电传感器、接近传感器、干簧管传感器、继电器传感器、微型电泵、磁敏（阻）传感器、压力开关、接近开关、光电开关、色标传感器、光纤传感器、齿轮测速传感器、时间继电器、计数器、计米器、温控仪、固态继电器、调压模块、电磁铁、电压表、电流表等特殊传感器。同时承接传感器应用电路、产品设计和自动化工程项目。

欢迎索取免费详细资料、设计指南和光盘；产品凡多，未能尽录，欢迎来电查询。

更多产品请看本公司产品专用销售网站：

商斯达中国传感器科技信息网：<http://www.sensor-ic.com/>

商斯达工控安防网：<http://www.pc-ps.net/>

商斯达电子元器件网：<http://www.sunstare.com/>

商斯达微波光电产品网：[HTTP://www.rfoe.net/](http://www.rfoe.net/)

商斯达消费电子产品网：<http://www.icasic.com/>

商斯达军工产品网：<http://www.junpinic.com/>

商斯达实业科技产品网：<http://www.sunstars.cn/>传感器销售热线：

地址：深圳市福田区福华路福庆街鸿图大厦1602室

电话：0755-83607652 83376489 83376549 83370250 83370251 82500323

传真：0755-83376182 (0) 13902971329 MSN: [SUNS888@hotmail.com](mailto:SUNS888@hotmail.com)

邮编：518033 E-mail: [szss20@163.com](mailto:szss20@163.com) QQ: 195847376

深圳赛格展销部：深圳华强北路赛格电子市场2583号 电话：0755-83665529

技术支持：0755-83394033 13501568376

# 10 kPa On-Chip Temperature Compensated & Calibrated Silicon Pressure Sensors

The MPXM2010 device is a silicon piezoresistive pressure sensors providing a highly accurate and linear voltage output — directly proportional to the applied pressure. The sensor is a single, monolithic silicon diaphragm with the strain gauge and a thin-film resistor network integrated on-chip. The chip is laser trimmed for precise span and offset calibration and temperature compensation.

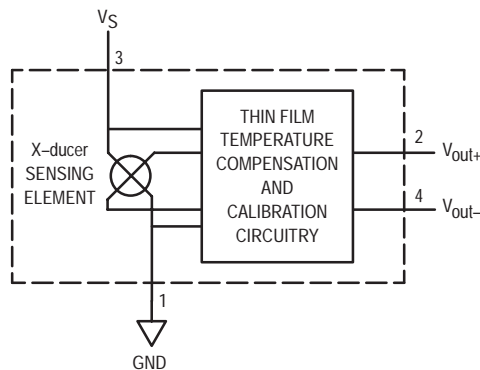
### Features

- Temperature Compensated Over 0°C to +85°C
- Unique Silicon Shear Stress Strain Gauge
- Easy to Use Tape & Reel
- Ratiometric to Supply Voltage
- Gauge Ported & Non Ported Options

### Application Examples

- Respiratory Diagnostics
- Air Movement Control
- Controllers
- Pressure Switching

Figure 1 shows a block diagram of the internal circuitry on the stand-alone pressure sensor chip.



**Figure 1. Temperature Compensated Pressure Sensor Schematic**

### VOLTAGE OUTPUT versus APPLIED DIFFERENTIAL PRESSURE

The differential voltage output of the X-ducer is directly proportional to the differential pressure applied.

The output voltage of the differential or gauge sensor increases with increasing pressure applied to the pressure side (P1) relative to the vacuum side (P2). Similarly, output voltage increases as increasing vacuum is applied to the vacuum side (P2) relative to the pressure side (P1).

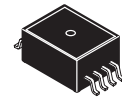
**Preferred** devices are Motorola recommended choices for future use and best overall value.

X-ducer is a trademark of Motorola, Inc.

## MPXM2010 SERIES

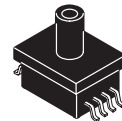
Motorola Preferred Device

**0 to 10 kPa (0 to 1.45 psi)**  
**25 mV FULL SCALE SPAN**  
**(TYPICAL)**



SCALE 2:1

**CASE 1320**  
**MPAK, STYLE 1**



SCALE 2:1

**CASE 1320A**  
**MPAK, STYLE 1**

### PIN NUMBER

1	Gnd	3	V <sub>S</sub>
2	+V <sub>out</sub>	4	-V <sub>out</sub>



## MAXIMUM RATINGS

Rating	Symbol	Value	Unit
Overpressure <sup>(8)</sup> (P1 > P2)	P <sub>max</sub>	75	kPa
Storage Temperature	T <sub>stg</sub>	-40 to +125	°C
Operating Temperature	T <sub>A</sub>	-40 to +125	°C

OPERATING CHARACTERISTICS (V<sub>S</sub> = 10 Vdc, T<sub>A</sub> = 25°C unless otherwise noted, P1 > P2)

Characteristic	Symbol	Min	Typ	Max	Unit
Pressure Range <sup>(1)</sup>	P <sub>OP</sub>	0	—	10	kPa
Supply Voltage <sup>(2)</sup>	V <sub>S</sub>	—	10	16	Vdc
Supply Current	I <sub>o</sub>	—	6.0	—	mAdc
Full Scale Span <sup>(3)</sup>	V <sub>FSS</sub>	24	25	26	mV
Offset <sup>(4)</sup>	V <sub>off</sub>	-1.0	—	1.0	mV
Sensitivity	ΔV/ΔP	—	2.5	—	mV/kPa
Linearity <sup>(5)</sup>	—	-1.0	—	1.0	%V <sub>FSS</sub>
Pressure Hysteresis <sup>(5)</sup> (0 to 10 kPa)	—	—	±0.1	—	%V <sub>FSS</sub>
Temperature Hysteresis <sup>(5)</sup> (-40°C to +125°C)	—	—	±0.5	—	%V <sub>FSS</sub>
Temperature Effect on Full Scale Span <sup>(5)</sup>	TCV <sub>FSS</sub>	-1.0	—	1.0	%V <sub>FSS</sub>
Temperature Effect on Offset <sup>(5)</sup>	TCV <sub>off</sub>	-1.0	—	1.0	mV
Input Impedance	Z <sub>in</sub>	1000	—	2550	Ω
Output Impedance	Z <sub>out</sub>	1400	—	3000	Ω
Response Time <sup>(6)</sup> (10% to 90%)	t <sub>R</sub>	—	1.0	—	ms
Warm-Up	—	—	20	—	ms
Offset Stability <sup>(9)</sup>	—	—	±0.5	—	%V <sub>FSS</sub>

## MECHANICAL CHARACTERISTICS

Characteristic	Symbol	Min	Typ	Max	Unit
Common Mode Line Pressure <sup>(7)</sup>	—	—	—	75	kPa

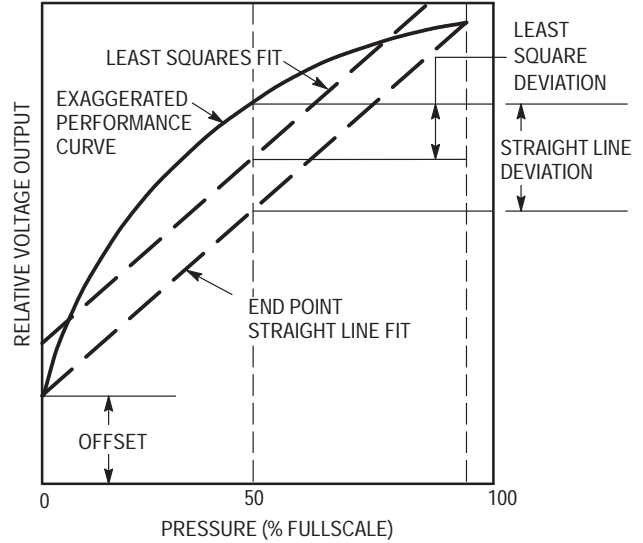
## NOTES:

- 1.0 kPa (kiloPascal) equals 0.145 psi.
- Device is ratiometric within this specified excitation range. Operating the device above the specified excitation range may induce additional error due to device self-heating.
- Full Scale Span (V<sub>FSS</sub>) is defined as the algebraic difference between the output voltage at full rated pressure and the output voltage at the minimum rated pressure.
- Offset (V<sub>off</sub>) is defined as the output voltage at the minimum rated pressure.
- Accuracy (error budget) consists of the following:
  - Linearity: Output deviation from a straight line relationship with pressure, using end point method, over the specified pressure range.
  - Temperature Hysteresis: Output deviation at any temperature within the operating temperature range, after the temperature is cycled to and from the minimum or maximum operating temperature points, with zero differential pressure applied.
  - Pressure Hysteresis: Output deviation at any pressure within the specified range, when this pressure is cycled to and from the minimum or maximum rated pressure, at 25°C.
  - TcSpan: Output deviation at full rated pressure over the temperature range of 0 to 85°C, relative to 25°C.
  - TcOffset: Output deviation with minimum rated pressure applied, over the temperature range of 0 to 85°C, relative to 25°C.
- Response Time is defined as the time for the incremental change in the output to go from 10% to 90% of its final value when subjected to a specified step change in pressure.
- Common mode pressures beyond specified may result in leakage at the case-to-lead interface.
- Exposure beyond these limits may cause permanent damage or degradation to the device.
- Offset stability is the product's output deviation when subjected to 1000 hours of Pulsed Pressure, Temperature Cycling with Bias Test.

**LINEARITY**

Linearity refers to how well a transducer's output follows the equation:  $V_{out} = V_{off} + \text{sensitivity} \times P$  over the operating pressure range. There are two basic methods for calculating nonlinearity: (1) end point straight line fit (see Figure 2) or (2) a least squares best line fit. While a least squares fit gives the "best case" linearity error (lower numerical value), the calculations required are burdensome.

Conversely, an end point fit will give the "worst case" error (often more desirable in error budget calculations) and the calculations are more straightforward for the user. Motorola's specified pressure sensor linearities are based on the end point straight line method measured at the midrange pressure.

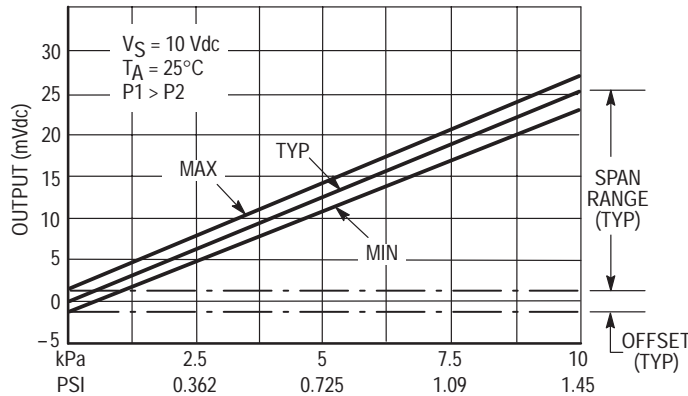


**Figure 2. Linearity Specification Comparison**

**ON-CHIP TEMPERATURE COMPENSATION and CALIBRATION**

Figure 3 shows the minimum, maximum and typical output characteristics of the MPXM2010 series at 25°C. The output is directly proportional to the differential pressure and is essentially a straight line.

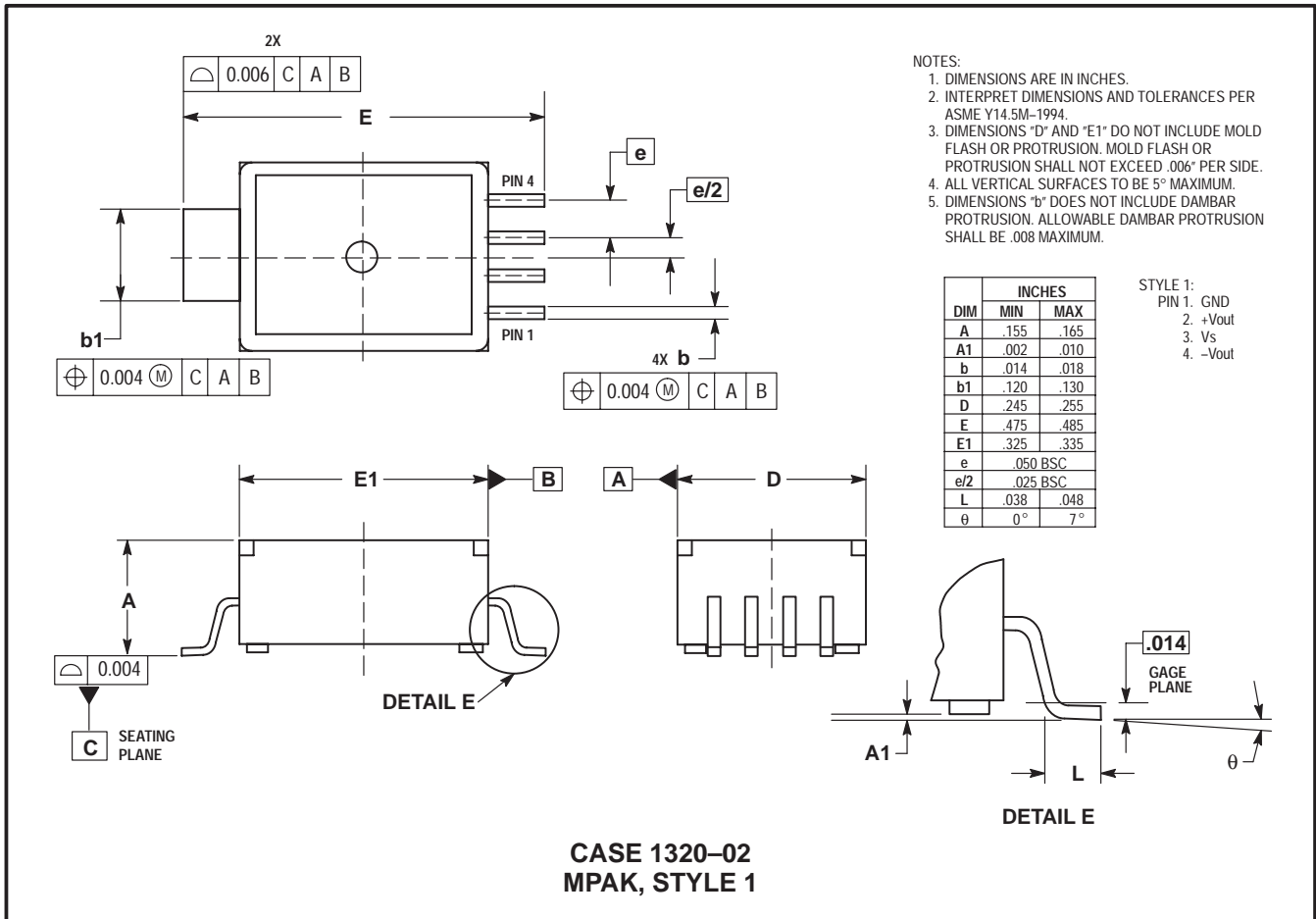
A silicone gel isolates the die surface and wire bonds from the environment, while allowing the pressure signal to be transmitted to the silicon diaphragm.

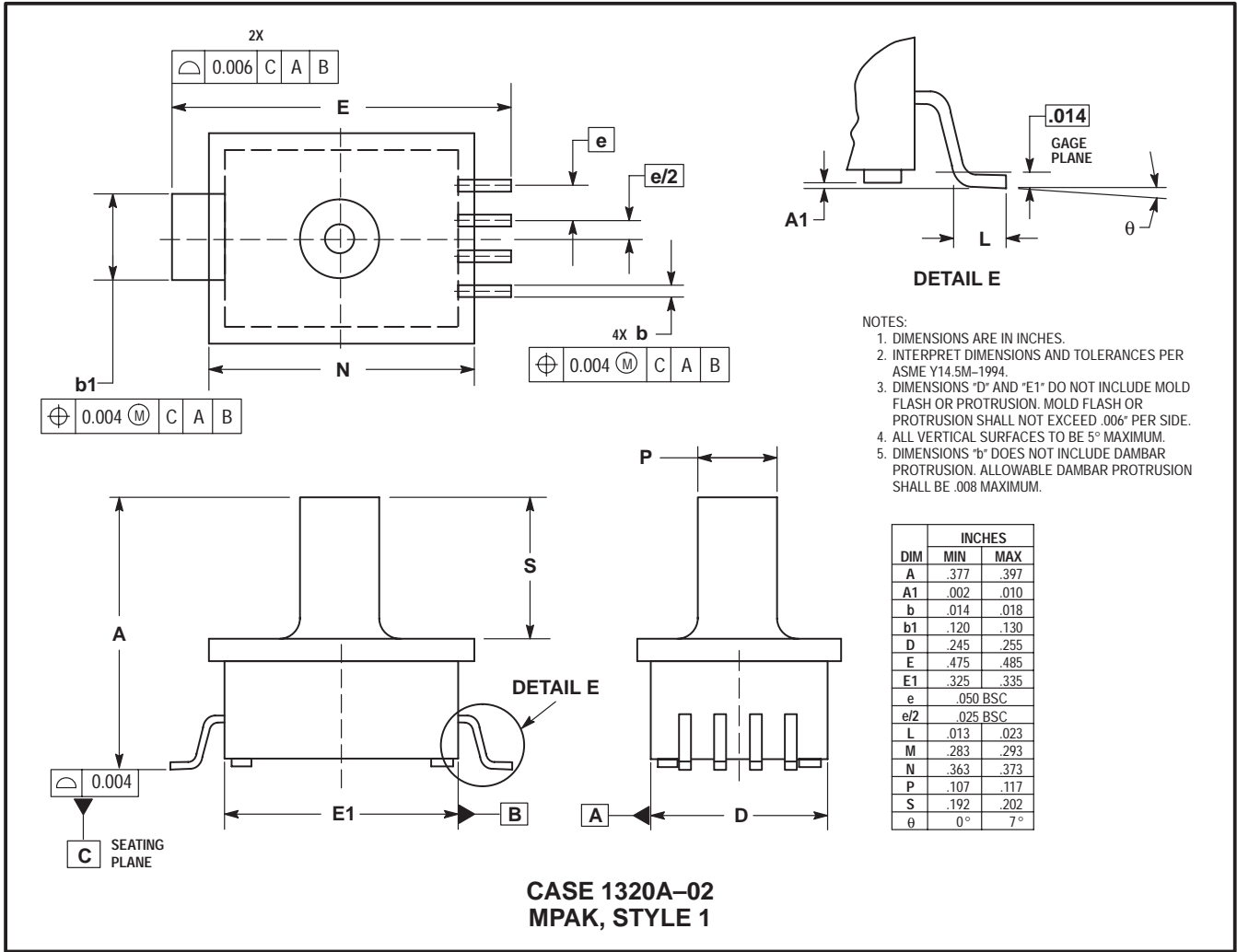


**Figure 3. Output versus Pressure Differential**

ORDERING INFORMATION	
Device Type	Options
MPXM2010D	Non-ported
MPXM2010DT1	Non-ported, Tape and Reel
MPXM2010GS	Ported
MPXM2010GST1	Ported, Tape and Reel

PACKAGE DIMENSIONS






# NOTES



# NOTES

Motorola reserves the right to make changes without further notice to any products herein. Motorola makes no warranty, representation or guarantee regarding the suitability of its products for any particular purpose, nor does Motorola assume any liability arising out of the application or use of any product or circuit, and specifically disclaims any and all liability, including without limitation consequential or incidental damages. "Typical" parameters which may be provided in Motorola data sheets and/or specifications can and do vary in different applications and actual performance may vary over time. All operating parameters, including "Typicals" must be validated for each customer application by customer's technical experts. Motorola does not convey any license under its patent rights nor the rights of others. Motorola products are not designed, intended, or authorized for use as components in systems intended for surgical implant into the body, or other applications intended to support or sustain life, or for any other application in which the failure of the Motorola product could create a situation where personal injury or death may occur. Should Buyer purchase or use Motorola products for any such unintended or unauthorized application, Buyer shall indemnify and hold Motorola and its officers, employees, subsidiaries, affiliates, and distributors harmless against all claims, costs, damages, and expenses, and reasonable attorney fees arising out of, directly or indirectly, any claim of personal injury or death associated with such unintended or unauthorized use, even if such claim alleges that Motorola was negligent regarding the design or manufacture of the part. Motorola and  are registered trademarks of Motorola, Inc. Motorola, Inc. is an Equal Opportunity/Affirmative Action Employer.



SUNSTAR商斯达实业集团是集研发、生产、工程、销售、代理经销、技术咨询、信息服务等为一体的高科技企业，是专业高科技电子产品生产厂家，是具有 10 多年历史的专业电子元器件供应商，是中国最早和最大的仓储式连锁规模经营大型综合电子零部件代理分销商之一，是一家专业代理和分销世界各大品牌 IC 芯片和电子元器件的连锁经营综合性国际公司。在香港、北京、深圳、上海、西安、成都等全国主要电子市场设有直属分公司和产品展示展销窗口门市部专卖店及代理分销商，已在全国范围内建成强大统一的供货和代理分销网络。我们专业代理经销、开发生产电子元器件、集成电路、传感器、微波光电元器件、工控机/DOC/DOM 电子盘、专用电路、单片机开发、MCU/DSP/ARM/FPGA 软件硬件、二极管、三极管、模块等，是您可靠的一站式现货配套供应商、方案提供商、部件功能模块开发配套商。专业以现代信息产业（计算机、通讯及传感器）三大支柱之一的传感器为主营业务，专业经营各类传感器的代理、销售生产、网络信息、科技图书资料及配套产品设计、工程开发。我们的专业网站——中国传感器科技信息网（全球传感器数据库）[www.SENSOR-IC.COM](http://www.SENSOR-IC.COM) 服务于全球高科技生产商及贸易商，为企业科技产品开发提供技术交流平台。欢迎各厂商互通有无、交换信息、交换链接、发布寻求代理信息。欢迎国外高科技传感器、变送器、执行器、自动控制产品厂商介绍产品到中国，共同开拓市场。本网站是关于各种传感器-变送器-仪器仪表及工业自动化大型专业网站，深入到工业控制、系统工程计 测量、自动化、安防报警、消费电子等众多领域，把最新的传感器-变送器-仪器仪表买卖信息，最新技术供求，最新采购商，行业动态，发展方向，最新的技术应用和市场资讯及时的传递给广大科技开发、科学研究、产品设计人员。本网站已成功为石油、化工、电力、医药、生物、航空、航天、国防、能源、冶金、电子、工业、农业、交通、汽车、矿山、煤炭、纺织、信息、通信、IT、安防、环保、印刷、科研、气象、仪器仪表等领域从事科学研究、产品设计、开发、生产制造的科技人员、管理人员、和采购人员提供满意服务。我们公司专业生产、代理、经销、销售各种传感器、变送器、敏感元器件、开关、执行器、仪器仪表、自动化控制系统：专业从事设计、生产、销售各种传感器、变送器、各种测控仪表、热工仪表、现场控制器、计算机控制系统、数据采集系统、各类环境监控系统、专用控制系统应用软件以及嵌入式系统开发及应用等工作。如热敏电阻、压敏电阻、温度传感器、温度变送器、湿度传感器、湿度变送器、气体传感器、气体变送器、压力传感器、压力变送、称重传感器、物（液）位传感器、物（液）位变送器、流量传感器、流量变送器、电流（压）传感器、溶氧传感器、霍尔传感器、图像传感器、超声波传感器、位移传感器、速度传感器、加速度传感器、扭距传感器、红外传感器、紫外传感器、火焰传感器、激光传感器、振动传感器、轴角传感器、光电传感器、接近传感器、干簧管传感器、继电器传感器、微型电泵、磁敏（阻）传感器、压力开关、接近开关、光电开关、色标传感器、光纤传感器、齿轮测速传感器、时间继电器、计数器、计米器、温控仪、固态继电器、调压模块、电磁铁、电压表、电流表等特殊传感器。同时承接传感器应用电路、产品设计和自动化工程项目。

更多产品请看本公司产品专用销售网站：

商斯达中国传感器科技信息网：<http://www.sensor-ic.com/>

商斯达工控安防网：<http://www.pc-ps.net/>

商斯达电子元器件网：<http://www.sunstare.com/>

商斯达微波光电产品网：[HTTP://www.rfoe.net/](http://www.rfoe.net/)

商斯达消费电子产品网：<http://www.icasic.com/>

商斯达军工产品网：<http://www.junpinic.com/>

商斯达实业科技产品网：<http://www.sunstars.cn/> 传感器销售热线：

地址：深圳市福田区福华路福庆街鸿图大厦 1602 室

电话：0755-83607652 83376489 83376549 83370250 83370251 82500323

传真：0755-83376182 (0) 13902971329 MSN: [SUNS888@hotmail.com](mailto:SUNS888@hotmail.com)

邮编：518033 E-mail: [szss20@163.com](mailto:szss20@163.com) QQ: 195847376

深圳赛格展销部：深圳华强北路赛格电子市场 2583 号 电话：0755-83665529 25059422

技术支持：0755-83394033 13501568376

欢迎索取免费详细资料、设计指南和光盘；产品凡多，未能尽录，欢迎来电查询。

北京分公司：北京海淀区知春路 132 号中发电子大厦 3097 号

TEL: 010-81159046 82615020 13501189838 FAX: 010-62543996

上海分公司：上海市北京东路 668 号上海赛格电子市场 D125 号

TEL: 021-28311762 56703037 13701955389 FAX: 021-56703037

西安分公司：西安高新开发区 20 所(中国电子科技集团导航技术研究所)

西安劳动南路 88 号电子商城二楼 D23 号

TEL: 029-81022619 13072977981 FAX:029-88789382