

AVX Single Layer Ceramic & MOS Capacitors for Applications from DC to Light

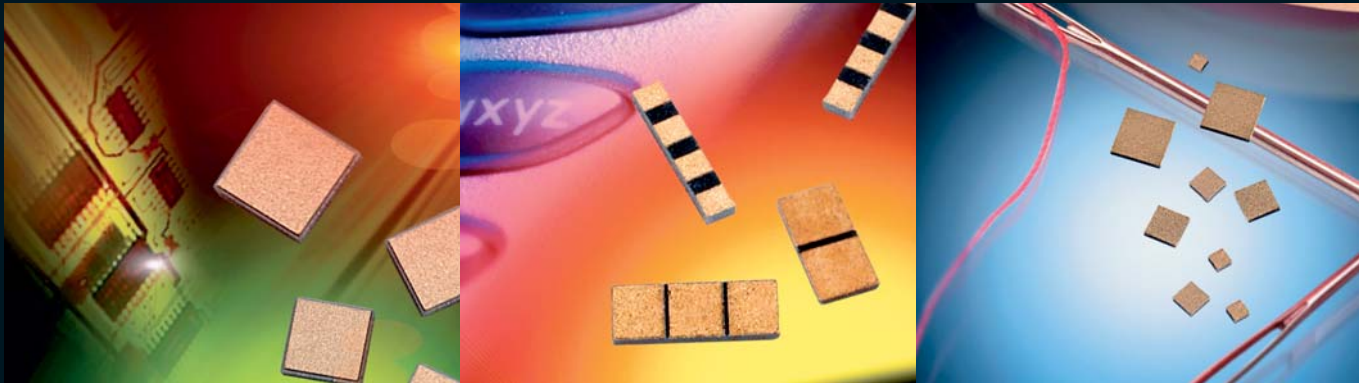

Version 6.1

AVX
A KYOCERA GROUP COMPANY



Microwave Single Layer Capacitors

Table of Contents

Single Layer Ceramic Capacitors (SLC's)

General Information

Dielectrics, Environmental Tests, How to Order (Catalog Number Description)2-3

GH/GB Series – SLC's with & without Borders

(Maxi & Maxi+ X7R Dielectrics)4-7

GH/GB Series – SLC's with & without Borders

(X7S Dielectrics – Code Z)8-9

GH/GB Series - SLC's with & without Borders

(NPO, Temp Compensating & X7R Dielectrics)10-11

GHB/GH** Series – Dual-Cap & Multi-Cap Arrays

(Multiple Dielectrics)12-13

GZ Series – Maxi Broadband DC Block Assemblies

.14-15

Ultra Maxi Series

.16

Metal Oxide Semiconductor (MOS) SLC's

.17-20

Introduction to Microwave Capacitors

.21-32

NOTICE: Specifications are subject to change without notice. Contact your nearest AVX Sales Office for the latest specifications. All statements, information and data given herein are believed to be accurate and reliable, but are presented without guarantee, warranty, or responsibility of any kind, expressed or implied. Statements or suggestions concerning possible use of our products are made without representation or warranty that any such use is free of patent infringement and are not recommendations to infringe any patent. The user should not assume that all safety measures are indicated or that other measures may not be required. Specifications are typical and may not apply to all applications.





Single Layer Capacitor Series

GENERAL INFORMATION

AVX offers a complete line of Single Layer Ceramic (SLC) Capacitors with dielectric constants ranging from 14 (NP0) to greater than 30,000 (X7R). Product offerings include standard SLC's (with & without borders) in all dielectric families. SLC's with double-sided borders are now available in most dielectrics as indicated in Table I. Also available are Dual-Caps & Multi-Cap Arrays as well as specialized assemblies for DC Blocking thru 40 GHz.

Our Maxi & Maxi+ grain boundary barrier layer (GBBL) Single Layer Ceramics provide a combination of high capacitance, voltage rating and small footprints unmatched in the industry and are ideally suited for broadband bypass applications. Additionally, our "Z" dielectric (also a GBBL material system) offers a cost effective alternative to Z5U & Y5V dielectrics with a much improved temperature coefficient over an expanded operating temperature range of -55°C to $+125^{\circ}\text{C}$.

Standard terminations are Ti/W-Au and Ti/W-Ni-Au. All terminations are sputtered providing excellent surfaces for wire bonding and exceptional adhesion characteristics. Wire bond tests are performed on every material lot. Bond strength must meet a minimum of 6 and 20 grams for 1 and 2 mil Au wire respectively (as compared to MIL-STD-883 limits of 3 and 8 grams) before being released to production (40 bonds with each wire size, zero failures permitted).

All parts are capable of meeting or exceeding the environmental & mechanical specifications in Table II.

In addition to an extensive offering of standard catalog devices, custom designs (and prototypes) are available upon request. Delivery of samples seldom exceeds two weeks once design parameters have been established.

PART NUMBER DESCRIPTION (see individual sheets for more detail)

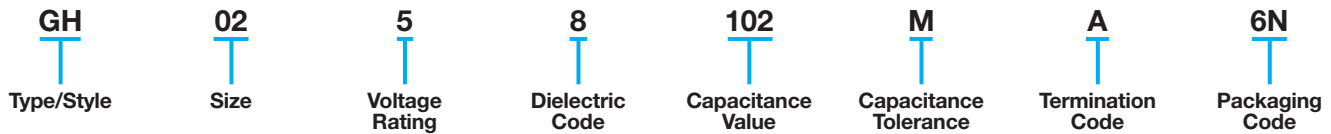

Single Layer Capacitor Series

GENERAL INFORMATION

TABLE I - Dielectric Codes, Types & Product Styles

Dielectric Type & Code		Dielectric Constant (K) typical	Temperature Coefficient	Temperature Range	Maximum DF	IR (Min) 25°C	Product Style Availability (Note 2)
NPO	A	14	0±30 ppm/°C	-55°C to +125°C	.6% @ 1MHz	100K Meg Ohms	1, 2, 3, 4, 6
	A	35	0±30 ppm/°C	-55°C to +125°C	.6% @ 1MHz	100K Meg Ohms	1, 2, 3, 4, 6
	A	80	0±30 ppm/°C	-55°C to +125°C	.7% @ 1MHz	100K Meg Ohms	1, 2, 3, 4, 6
Temp Comp	4	205	-1500±250 ppm/°C	-55°C to +125°C	.5% @ 1MHz	10K Meg Ohms	1, 2, 3
	7	370	-3300±1000 ppm/°C	-55°C to +125°C	1.0% @ 1MHz	10K Meg Ohms	1, 2, 3
	Y	650	-4700±1000 ppm/°C	-55°C to +125°C	1.0% @ 1MHz	10K Meg Ohms	1, 2, 3
X7R	C	1,200	±15%	-55°C to +125°C	2.5% @ 1KHz	10K Meg Ohms	1, 2, 3, 4, 6
	C	2,200					
	C	5,000					
X7S	Z	2,500	±22%	-55°C to +125°C	2.5% @ 1KHz	10K Meg Ohms	1, 2, 4, 5, 6
	Z	5,000					
	Z	9,000					
	Z	14,000					
	Z	18,000					
X7R	8 (Maxi)	20,000	±15%	-55°C to +125°C	2.5% @ 1KHz	10K Meg Ohms	1, 2, 4, 5, 6
X7R	9 (Maxi+)	30,000	±15%	-55°C to +125°C	2.5% @ 1KHz	10K Meg Ohms	1, 2, 4, 5, 6
X7R	0 (Ultra Maxi)	60,000	±15%	-55°C to +125°C	2.5% @ 1KHz	10K Meg Ohms	1, 4, 6

Note 1: Dielectric Codes E (Z5U) and G (Y5V) are available upon special request

- Note 2: 1 = Standard (no borders)
 2 = Standard SLC with borders
 3 = Standard SLC with double-sided borders
 4 = Dual Caps
 5 = Multi-Cap Arrays
 6 = Custom

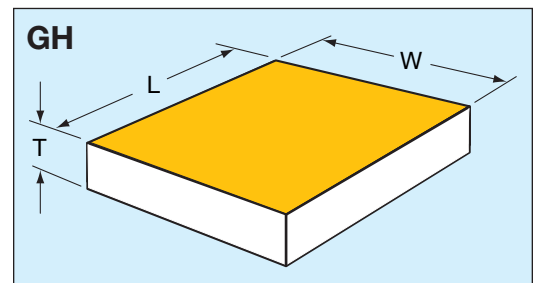
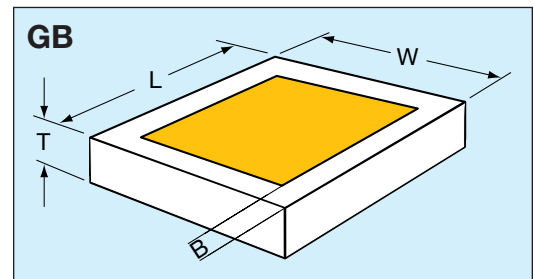

TABLE II

MIL Reference	Parameter	Method or Paragraph
MIL-STD-883	Bond Strength	2011.7
MIL-STD-883	Shear Strength	2019
MIL-C-55681	Voltage Conditioning	3.6
MIL-C-55681	Insulation Resistance	3.9
MIL-C-55681	Thermal Shock	3.14
MIL-C-55681	Voltage Temperature Limits	3.13
MIL-C-55681	Life Test	3.17
MIL-C-49464	All	



Maxi & Maxi+ Series: Single Layer Ceramics With & Without Borders

GENERAL INFORMATION

Maxi and Maxi+ are both AVX proprietary intergranular barrier layer dielectric formulations. Both use SrTiO₃ as their major constituent and have dielectric constants exceeding 20,000 and 30,000 respectively. Grain boundary barrier layer (GBBL) capacitors have been well discussed in various literature sources and, while simple in principle, their resulting electrical properties are dependent on a complex combination of materials and process technology.

AVX's Maxi & Maxi+ dielectrics have the distinctive properties that are ideal for extremely broadband by-pass capacitors. This built-in feature gives these products a unique dispersive effect that is illustrated in the accompanying curves. AVX's ability to control the prerequisite relationships between materials and process has resulted in dielectrics that make these Single Layer Ceramics especially well suited for applications requiring high frequency performance well into the millimeter band.

These GBBL dielectrics are also available in low loss versions that are comparable to conventional barium titanate based dielectrics. Performance is likewise similar in that these materials exhibit a very pronounced dip at their resonant frequency. These designs are excellent choices for applications requiring the combined attributes of very small size and precise cut-off frequencies. Additional information on these high Q products may be obtained by contacting the factory or your local AVX representative.

All Maxi & Maxi+ dielectrics exhibit X7R temperature performance of $\pm 15\%$ from -55°C to $+125^{\circ}\text{C}$. Electrical characteristics, as outlined in MIL-C-49464, will meet those specified for Class II dielectrics, rather than the less stringent Class IV, which typically describes GBBL dielectrics.

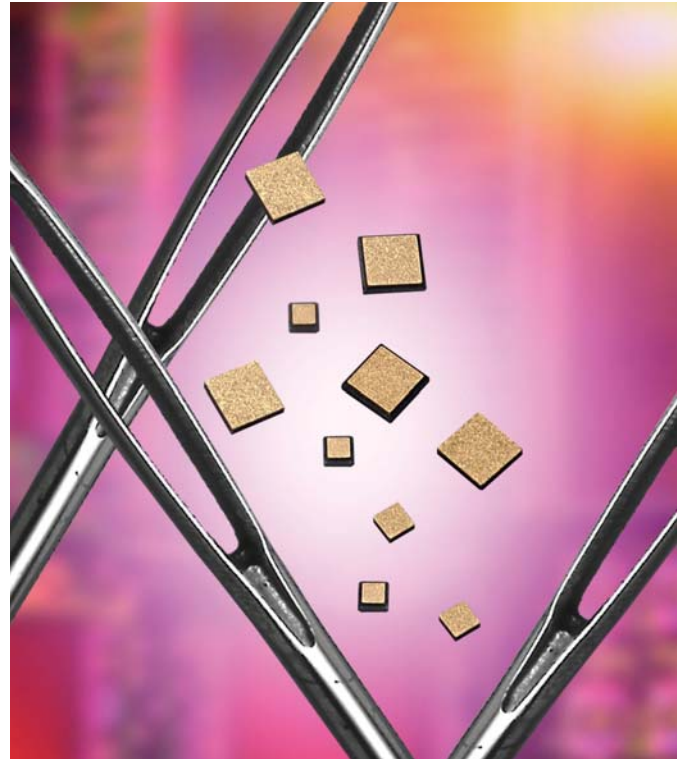

Sample kits are available

[MAXI KIT Catalog # KITSLCK20KSAMPL](#) includes 10 each:
GH0158101MA6N, GH0258221MA6N, GH0358471MA6N,
GH0358102MA6N, GH0458182MA6N

[MAXI+ KIT Catalog # KITSLCK30KSAMPL](#) includes 10 each:
GH0159331MA6N, GH0259751MA6N, GH0359152MA6N,
GH0459302MA6N, GH0559602MA6N

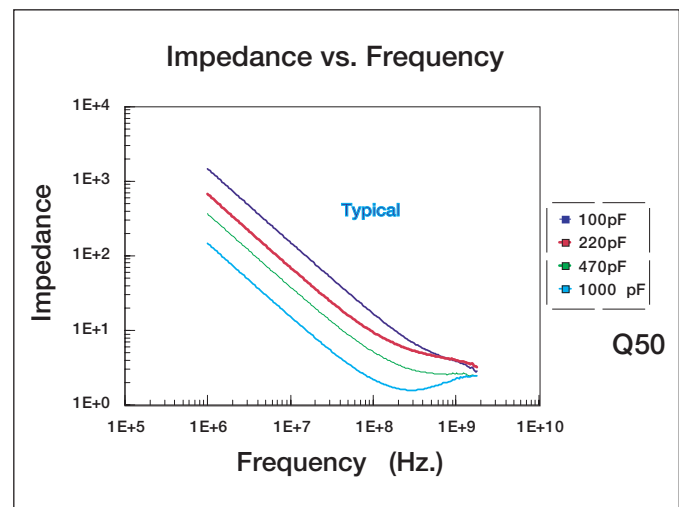
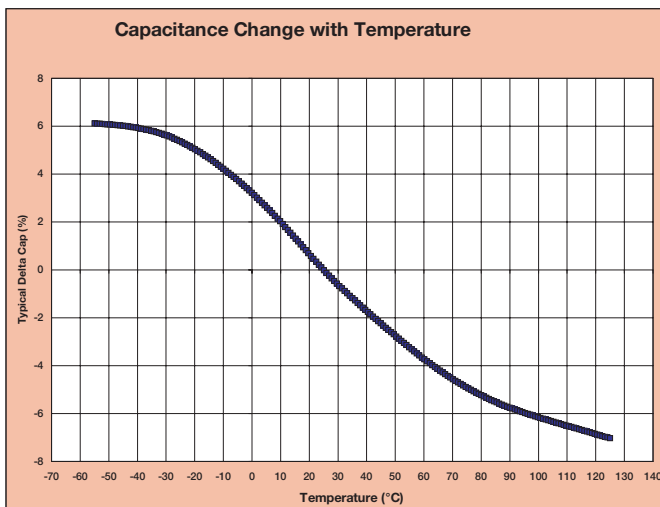



Maxi & Maxi+ Series: Single Layer Ceramics With & Without Borders

DIMENSIONS: inches (millimeters)

	GH/GB01	GH/GB02	GH/GB03	GH/GB04	GH/GB05	GH/GB06
(L) Length	.015±.005 (.381±.127)	.025±.005 (.635±.127)	.035±.005 (.889±.127)	.050±.010 (1.27±.254)	.070±.010 (1.78±.254)	.090±.010 (2.29±.254)
(W) Width	.015±.005 (.381±.127)	.025±.005 (.635±.127)	.035±.005 (.889±.127)	.050±.010 (1.27±.254)	.070±.010 (1.78±.254)	.090±.010 (2.29±.254)
(T) Thickness	.007±.002 (.178±.051)					
(B) Border	.002±.001 (.051±.025)					

GH SERIES: MAXI SINGLE LAYER CAPACITORS WITHOUT BORDERS

Cap (pF)		Cap (pF)		Cap (pF)		Cap (pF)		Cap (pF)		Cap (pF)	
Min	Max	Min	Max	Min	Max	Min	Max	Min	Max	Min	Max
68	330	330	750	750	1200	1200	2700	2700	4700	4700	8200

GH SERIES: MAXI+ SINGLE LAYER CAPACITORS WITHOUT BORDERS

Cap (pF)		Cap (pF)		Cap (pF)		Cap (pF)		Cap (pF)		Cap (pF)	
Min	Max	Min	Max	Min	Max	Min	Max	Min	Max	Min	Max
330	390	390	1000	1000	1800	1800	3300	3300	6800	6800	10000

GB SERIES: MAXI SINGLE LAYER CAPACITORS WITH BORDERS

Cap (pF)		Cap (pF)		Cap (pF)		Cap (pF)		Cap (pF)		Cap (pF)	
Min	Max	Min	Max	Min	Max	Min	Max	Min	Max	Min	Max
51	220	220	560	560	1000	1000	2200	2200	4700	4700	8200

GB SERIES: MAXI+ SINGLE LAYER CAPACITORS WITH BORDERS

Cap (pF)		Cap (pF)		Cap (pF)		Cap (pF)		Cap (pF)		Cap (pF)	
Min	Max	Min	Max	Min	Max	Min	Max	Min	Max	Min	Max
220	330	330	820	820	1500	1500	2700	2700	6800	6800	10000

HOW TO ORDER

GH	02	5	8	102	M	A	6N
Type Code	Case Size	Working Voltage Code	Dielectric Code	Capacitance Value	Capacitance Tolerance	Termination Code	Packaging Code
GH = w/o borders GB = w/ borders	01 02 03 04 05 06	5 = 50 VDC	8 = Maxi (k = 20,000) 9 = Maxi+ (k = 30,000)	EIA Cap Code in pF	K = ±10% M = ±20% Z = +80% -20%	A = Au (100 μ-in min) over Ti/W (1000 Å nom) also available N = Ti/W-Ni-Au	6N = Antistatic Waffle Pack

Performance Curves

S21 FORWARD TRANSMISSION

Capacitance = 220 pF Q = 50 @ 1 MHz
Size: L = .017" W = .017" T = .007"

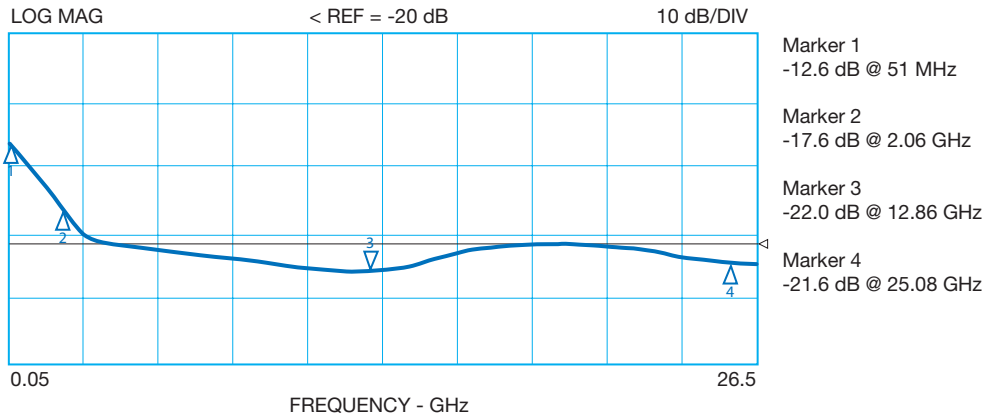

Capacitance = 470 pF Q = 50 @ 1 MHz
Size: L = .024" W = .024" T = .007"

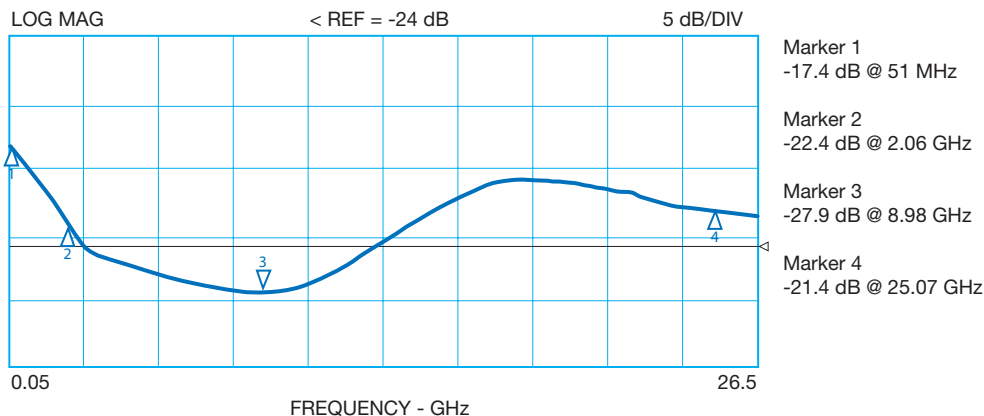

Capacitance = 1000 pF Q = 50 @ 1 MHz
Size: L = .035" W = .035" T = .007"

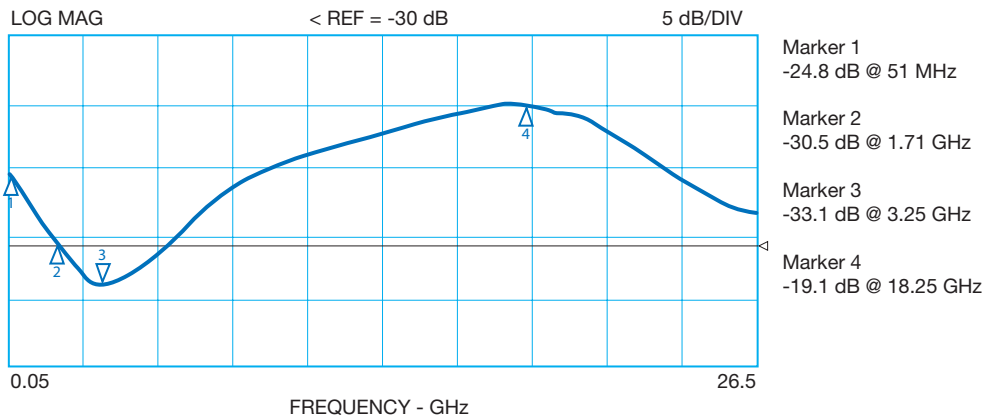

Performance Curves

S21 INSERTION LOSS

Capacitance = 220 pF Q = 50 @ 1 MHz
Size: L = .017" W = .017" T = .007"

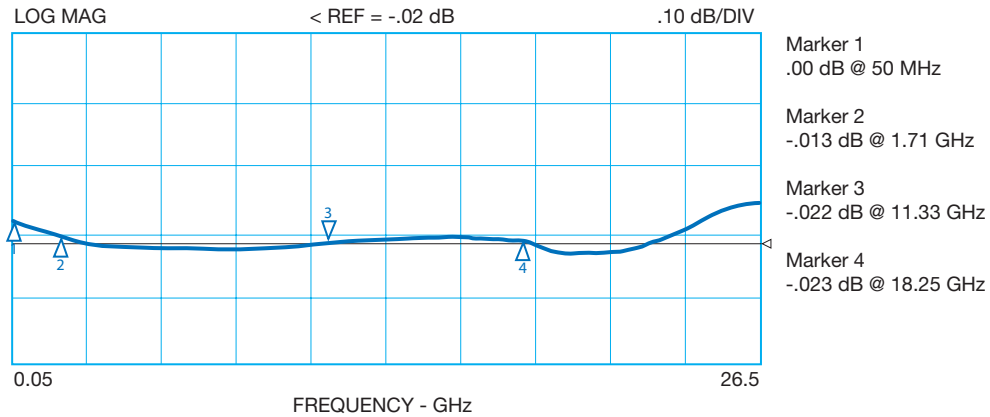

Capacitance = 470 pF Q = 50 @ 1 MHz
Size: L = .024" W = .024" T = .007"

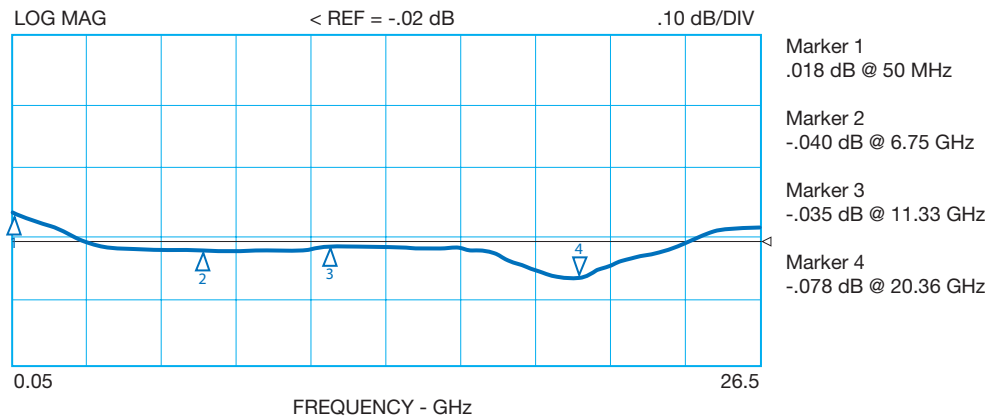

Capacitance = 1000 pF Q = 50 @ 1 MHz
Size: L = .035" W = .035" T = .007"

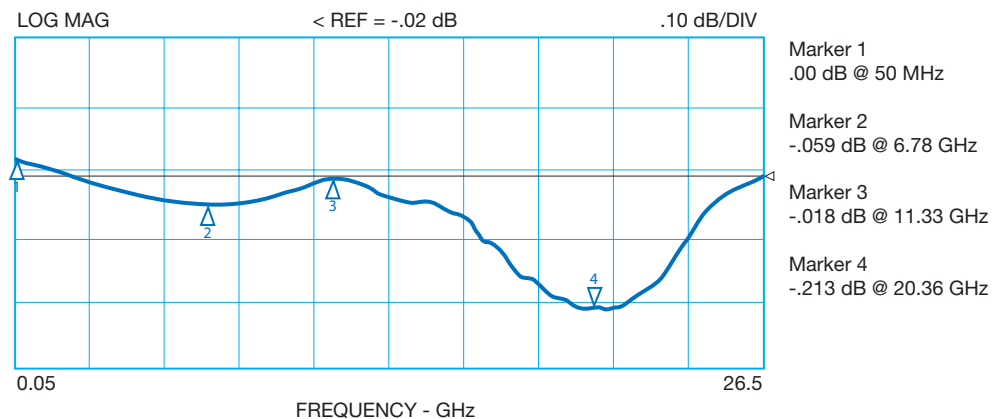



Microwave Single Layer X7S Capacitors

Z Dielectric With and Without Borders

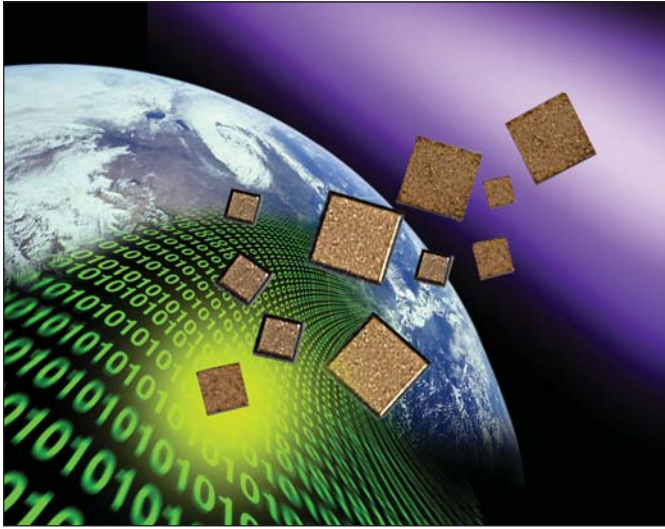

GENERAL INFORMATION

This grain boundary barrier layer (GBBL) system was developed as a replacement for conventional Z5U/Y5V dielectrics. With X7S temperature characteristics, the Z Series offers not only a significant improvement over the TCC of these two dielectrics, but does so over a much wider operating range of -55C to +125°C. Voltage ratings of 50 and 100VDC are available.

The Z Series is offered in a range of five dielectric constants (2,500, 5,000, 9,000, 14,000 and 18,000) and products are available with & without borders.

CAPACITANCE CHANGE WITH TEMPERATURE

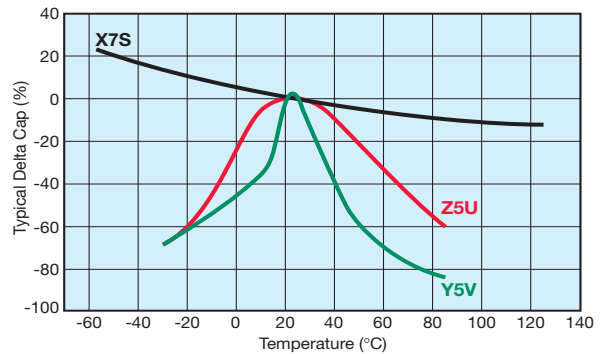

Sample kits are available

[ULTRA MAXI KIT Catalog # KITSLCZDIESAMPL](#)

includes 10 each:

GH015Z101MA6N, GH025Z221MA6N,

GH035Z471MA6N, GH045Z102MA6N

Samples of individual P/N's are also available

DIMENSIONS: inches (millimeters)

	GH/GB01	GH/GB02	GH/GB03	GH/GB04	GH/GB05	GH/GB06
(L) Length	.015±.005 (.381±.127)	.025±.005 (.635±.127)	.035±.005 (.889±.127)	.050±.010 (1.27±.254)	.070±.010 (1.78±.254)	.090±.010 (2.29±.254)
(T) Thickness	.007+.002, -.001 (.178+.051, -.025)					
(B) Border	.002±.001 (.051±.025)					

Z DIELECTRIC GH WITHOUT BORDERS

Cap (pF)		Cap (pF)		Cap (pF)		Cap (pF)		Cap (pF)		Cap (pF)	
Min	Max	Min	Max	Min	Max	Min	Max	Min	Max	Min	Max
20	200	35	470	80	800	150	2000	300	3000	500	4700

Z DIELECTRIC GH WITH BORDERS

Cap (pF)		Cap (pF)		Cap (pF)		Cap (pF)		Cap (pF)		Cap (pF)	
Min	Max	Min	Max	Min	Max	Min	Max	Min	Max	Min	Max
20	150	30	390	70	700	140	1800	280	2700	470	4500

HOW TO ORDER

GH	02	5	8	102	M	A	6N
Type Code	Case Size	Working Voltage Code	Dielectric Code	Capacitance	Capacitance Tolerance Code	Termination Code	Packaging Code
GH = No Borders GB = With Borders	01 02 03 04 05 06	5 = 50V 1 = 100V	Z = X7S (k = 2.5K-18K)	EIA Cap Code in pF	K = ±10% M = ±20% Z = +80% -20%	A = Au (100 μ-in min) over Ti/W (1000 Å nom) also available N = Ti/W-Ni-Au	6N = Antistatic Waffle Pack

Note: GH/GB01 & 02 above replace GH/GB10, 15, 20 & 25 and are slightly different dimensionally. Contact factory for details.
GH/GB03, 04, 05 & 06 replace GH/GB35, 50, 70 & 90 respectively and are dimensionally identical.



GENERAL INFORMATION

In addition to the standard SLC products shown below, AVX is now able to offer bordered versions in these same dielectric families as detailed on the opposing page utilizing micron resolution photolithography and etching processes.

With borders precisely defined, these parts will be beneficial in those applications that require enhanced visual definition during placement and wire bonding. Additionally, bordered devices have proven effective in reducing the susceptibility to conductive epoxy electrode bridging.

SLC's with double-sided borders, .010" & .012" square units and custom designs are available on request.

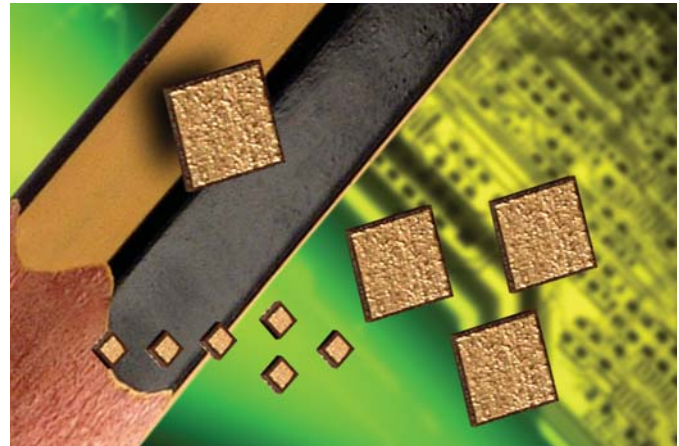

GH SERIES: SINGLE LAYER CAPACITORS WITHOUT BORDERS NP0, TEMPERATURE COMPENSATING & X7R DIELECTRICS

DIMENSIONS: inches (millimeters)

	GH10	GH15	GH20	GH25
(L) Length	.010±.003 (.254±.076)	.015±.005 (.381±.127)	.020±.005 (.508±.127)	.025±.005 (.635±.127)
(W) Width	.010±.003 (.254±.076)	.015±.000,-.003 (.381±.000,-.076)	.020±.000,-.003 (.508±.000,-.076)	.025±.000,-.003 (.635±.000,-.076)
(T) Thickness	.006±.002 (.152±.051)			

	Dielectric Code	k Factor	Min Cap Tolerance	Cap Value (pF)		Cap Value (pF)		Cap Value (pF)		Cap Value (pF)	
				Min	Max	Min	Max	Min	Max	Min	Max
NP0	A	14	±0.1 pF	0.05	0.10	0.10	0.20	0.20	0.40	0.30	0.50
	A	35	±0.1 pF	0.10	0.30	0.20	0.50	0.50	0.90	0.80	1.40
	A	80	±0.1 pF	0.20	0.60	0.50	1.2	1.00	2.00	1.70	3.00
Temp Comp	4	205	±0.25 pF	0.60	1.70	1.30	3.00	2.60	5.20	4.40	8.00
	7	370	±0.25 pF	1.00	3.00	2.40	5.50	4.80	9.50	8.00	14.00
	Y	650	±0.25 pF	1.80	5.00	4.00	10.00	8.40	16.00	14.00	25.00
X7R	C	1200	±10%	3.40	10.00	7.70	18.00	15.00	31.00	25.00	47.00
	C	2200	±10%	7.00	18.00	14.00	33.00	28.00	56.00	48.00	86.00
	C	5000	±10%	15.00	40.00	32.00	74.00	65.00	130.00	110.00	200.00

DIMENSIONS: inches (millimeters)

	GH35	GH50	GH70	GH90
(L) Length	.035±.005 (.889±.127)	.050±.010 (1.27±.254)	.070±.010 (1.78±.254)	.090±.010 (2.29±.254)
(W) Width	.035±.005 (.889±.127)	.050±.010 (1.27±.254)	.070±.010 (1.78±.254)	.090±.010 (2.29±.254)
(T) Thickness	.006±.002 (.152±.051)		.007±.002 (.178±.051)	

	Dielectric Code	k Factor	Min Cap Tolerance	Cap Value (pF)		Cap Value (pF)		Cap Value (pF)		Cap Value (pF)	
				Min	Max	Min	Max	Min	Max	Min	Max
NP0	A	14	±0.1 pF	0.60	1.20	1.30	2.70	1.70	3.20	3.80	5.00
	A	35	±0.1 pF	1.60	3.00	3.30	6.80	4.30	8.00	9.50	13.00
	A	80	±0.1 pF	3.60	6.80	7.50	15.60	10.00	18.00	22.00	29.00
Temp Comp	4	205	±0.25 pF	9.40	18.00	19.00	40.00	25.00	46.00	56.00	73.00
	7	370	±0.25 pF	17.00	32.00	35.00	72.00	45.00	84.00	100.00	130.00
	Y	650	±0.25 pF	30.00	55.00	61.00	130.00	80.00	150.00	180.00	230.00
X7R	C	1200	±10%	55.00	100.00	110.00	230.00	150.00	270.00	330.00	430.00
	C	2200	±10%	100.00	190.00	200.00	430.00	270.00	500.00	600.00	780.00
	C	5000	±10%	230.00	430.00	470.00	980.00	620.00	1100.00	1400.00	1800.00

GB SERIES: SINGLE LAYER CAPACITORS WITH BORDERS NP0, TEMPERATURE COMPENSATING & X7R DIELECTRICS

DIMENSIONS: inches (millimeters)

Case Code/Size		GB15			GB20			GB25			GB30		
Length & Width		.015±.002 (.381±.051)			.020±.002 (.508±.051)			.025±.002 (.635±.051)			.030±.002 (.762±.051)		
Thickness Min/Max		.0045/.012 (.114/.035)											
(B) Border		.002+.002,-.001 (.051+.051,-.025)											
Dielectric	k	Cap (pF)			Cap (pF)			Cap (pF)			Cap (pF)		
		Min	Max	Tol*	Min	Max	Tol*	Min	Max	Tol*	Min	Max	Tol*
A	14	0.06	0.1	A	0.1	0.2	A	0.2	0.3	A	0.3	0.4	A
A	31	0.1	0.2	A	0.3	0.4	B	0.4	0.7	B	0.6	1	B
A	60	0.3	0.4	B	0.5	0.8	C	0.8	1.3	C	1.2	2	C
4	200	0.9	1.3	D	1.5	2.7	D	2.7	4.7	M	3.9	6.8	K
7	420	1.5	2.4	D	2.7	4.7	M	4.7	8.2	M	6.8	12	K
Y	650	2.7	4.7	M	4.7	9.1	M	8.2	15	M	12	22	K
C	1100	4.7	7.5	M	8.2	15	M	15	24	M	22	36	K
C	2000	9.1	13	M	16	27	M	27	47	M	39	68	K
C	4200	20	33	M	36	62	M	56	100	M	91	150	K

DIMENSIONS: inches (millimeters)

Case Code/Size		GB35			GB40			GB50		
Length & Width		.035±.002 (.899±.051)			.040±.002 (1.016±.051)			.050±.002 (1.270±.051)		
Thickness Min/Max		.0045/.012 (.114/.035)								
(B) Border		.002+.002,-.001 (.051+.051,-.025)								
Dielectric	k	Cap (pF)			Cap (pF)			Cap (pF)		
		Min	Max	Tol*	Min	Max	Tol*	Min	Max	Tol
A	14	0.4	0.6	A	0.5	0.9	B	0.8	1.3	B
A	31	0.8	1.5	C	1.1	2	C	1.8	3	C
A	60	1.6	3	C	2.2	3.9	C	3.6	6.2	D
4	200	5.1	9.1	K	6.8	13	K	11	20	K
7	420	9.1	16	K	12	22	K	20	36	K
Y	650	18	30	K	22	39	K	36	62	K
C	1100	30	51	K	39	68	K	62	110	K
C	2000	51	91	K	68	120	K	110	200	K
C	4200	120	200	K	160	270	K	270	430	K

Note: Tol* - Letter indicates tightest available

HOW TO ORDER

GH	16	5	A	6R8	K	N	6N
Type Code	Case Code	Working Voltage	Dielectric Code	Capacitance Value	Capacitance Tolerance	Termination Code	Packaging Code
GH = w/o borders GB = w/ borders		5 = 50WVDC 1 = 100WVDC	A = NP0 4 = TC 7 = TC Y = TC C = X7R	EIA Cap Code in pF First two digits = significant figures or "R" for decimal place. Third digit = number of zeros or after "R" significant figures.	A = ±0.05pF B = ±0.1pF C = ±0.25pF D = ±0.5pF G = ±2% J = ±5% K = ±10% M = ±20%	N = Ti/W-Ni-Au Au (100µ-in min) over Ni (1500Å nom) over Ti/W (500Å nom)	6N = Antistatic Waffle Pack



Microwave SLCs

Multi-Cap Arrays

GENERAL INFORMATION

AVX Multi-Cap Arrays are available with 2, 3, 4, 5 or 6 capacitors on one single layer capacitor substrate. Dual-Caps are available in NP0, X7R, X7S (Z), Maxi and Maxi+ dielectrics. Multi-Caps are available in dielectrics Z, Maxi and Maxi+.

These arrays have advantages over single components in the form of smaller overall size, reduced handling and lower average unit costs. They are, therefore, a good choice for broad-band bypass applications where circuit board layouts can utilize these configurations.

The designs, shown along with the range of maximum capacitance values, represent typical parts. Since most applications require specific form factors, custom designs on all multi-cap arrays are available to meet individual customer requirements and are offered with quick turn around. No charge samples are generally shipped within two weeks of the design sign-off.

Both standard and custom designs are available with borders for those applications where conductive epoxy run up exposes the parts to the possibility of shorting. Maximum capacitance per pad for bordered devices will be necessarily somewhat lower than shown on the adjacent page.

2 and 3 cap arrays can be designed with different capacitance values per pad in circuit designs where identical values pad-to-pad are, for one reason or another, not altogether suitable.

Additionally, the dual-caps are available to match micro strip widths as dictated by circuit considerations. When mounted with the individual pads down, the need for wire bonding is eliminated. The maximum capacitance values indicated on the typical designs shown represent capacitance per pad. Mounted with both pads down puts two capacitors in series. The effective series capacitance (C_{Eff}), can be determined by $1/C_{Eff} = 1/C1 + 1/C2$.

Contact the factory or your local AVX representative.

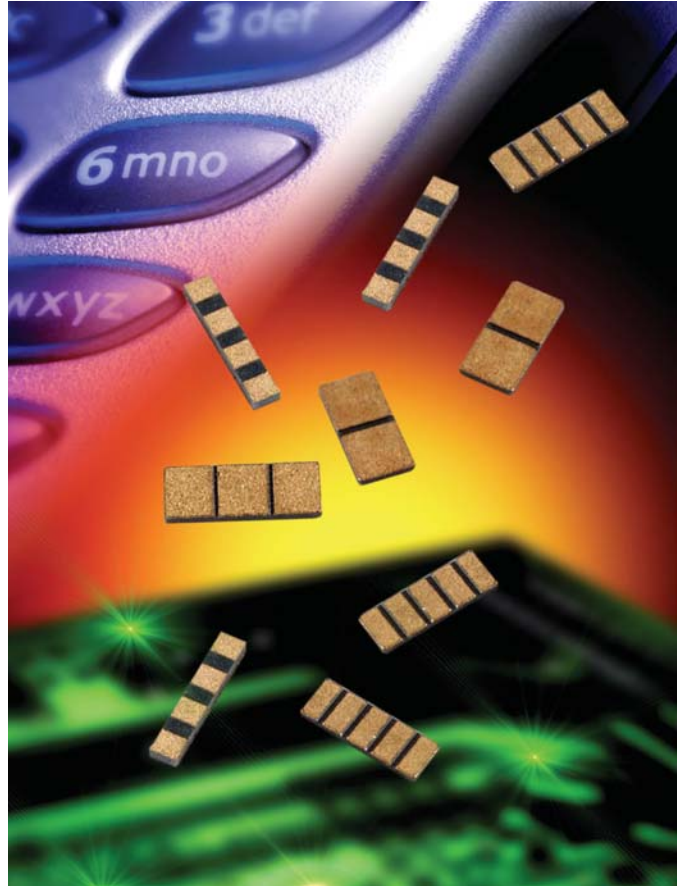

DUAL-CAP

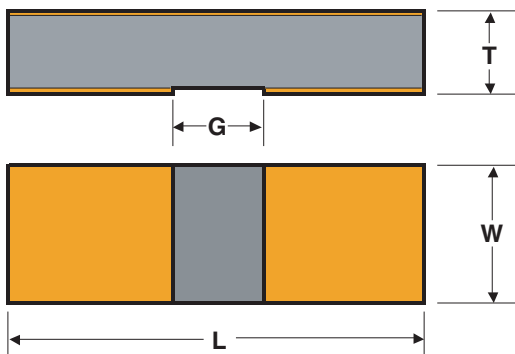

MULTI-CAP

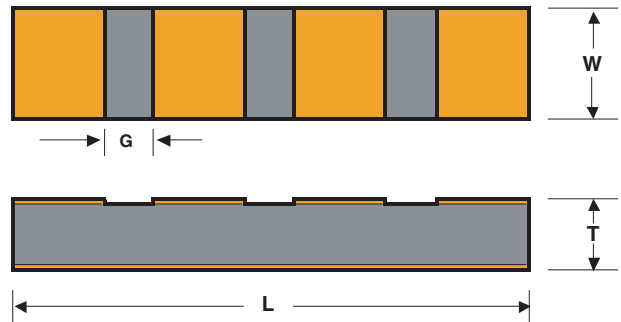

Multi-Cap Arrays

GHB SERIES: DUAL CAP SINGLE LAYER CAPACITORS

DIMENSIONS: inches (millimeters)

	GHB2	GHB3	GHB4	GHB5	
(L) Length	.050±.010 (1.27±.254)	.080±.010 (2.03±.254)			
(W) Width	.020+.000,-.003 (.508+.000,-.076)	.025+.000,-.003 (.635+.000,-.076)	.030+.000,-.003 (.762+.000,-.076)	.040+.000,-.003 (1.02+.000,-.076)	.050+.000,-.003 (1.27+.000,-.076)
(T) Thickness	.008±.002 (.203±.051)				
(G) Gap	.005 min/.010 max (.127/.254)				

Dielectric	Cap/Pad (pF)		Cap/Pad (pF)		Cap/Pad (pF)		Cap/Pad (pF)		Cap/Pad (pF)	
	Min	Max	Min	Max	Min	Max	Min	Max	Min	Max
A	0.2	1.2	0.4	2.6	0.5	3.1	0.7	4.2	0.9	5.7
C	18	75	39	160	47	200	63	260	78	330
Z	25	220	54	500	65	600	88	770	100	960
Maxi	200	350	430	780	520	940	700	1200	870	1500
Maxi+	270	450	600	1000	730	1200	980	1500	1200	1900

GH-SERIES: MULTI-CAP ARRAY SINGLE LAYER CAPACITORS

DIMENSIONS: inches (millimeters)

	GH*2	GH*Y	GH*3	GH*6
Length - Code (C) - 3 Caps	.065±.010 (1.65±.254)			
Length - Code (D) - 4 Caps	.090±.010 (2.29±.254)			
Length - Code (E) - 5 Caps	.115±.010 (2.92±.254)			
Length - Code (F) - 6 Caps	.140±.010 (3.56±.254)			
(W) Width	.020±.005 (.508±.127)	.025±.005 (.635±.127)	.030±.005 (.762±.127)	.040±.005 (1.02±.127)
(T) Thickness	.008±.002 (.203±.051)			
Pad Size (nominal)	.020x.015 (.508x.381)	.025x.015 (.635x.381)	.030x.015 (.762x.381)	.040x.015 (1.02x.381)
(G) Gap (All Arrays)	.005 min/.010 max (.127/.254)			

Dielectric	Cap/Pad (pF)		Cap/Pad (pF)		Cap/Pad (pF)		Cap/Pad (pF)	
	Min	Max	Min	Max	Min	Max	Min	Max
Z	20	120	25	150	30	180	40	250
Maxi	140	200	170	250	210	300	280	400
Maxi+	200	300	250	370	300	450	400	600

HOW TO ORDER

GH Type Code	B Array Code B = 2 C = 3 D = 4 E = 5 F = 6	5 Size Code 2 = .020" W Y = .025" W 3 = .030" W 4 = .040" W 5 = .050" W S = Special	5 Working Voltage Code 5 = 50VDC	8 Dielectric Code A = NP0 C = X7R Z = X7S 8 = Maxi 9 = Maxi+	102 Cap Code EIA Cap Code in pF	P Cap Tolerance P = +100% -0% Z = +80% -20% Dual-Caps M = ±20% available	A Termination Code A = Au (100 μ-in min) over Ti/W (1000 Å nom) also available N = Ti/W-Ni-Au	6N Packaging Code 6N = Antistatic Waffle Pack
-----------------------------	--	--	--	--	---	--	---	---

Maxi Broadband DC Block to 40GHz

GENERAL INFORMATION

The GZ Series was developed specifically to address DC Blocking issues from ~15KHz through 40GHz and incorporate small footprints to conserve board space. The three parts in this series are designed to match .015" (0.381mm) and .020" (0.508mm) micro strip widths. These assemblies (patent pending) combine high capacitance Ni-Au terminated MLC's for low frequency coverage and specially configured Maxi dielectric Single Layer Ceramics to facilitate conventional surface mounting. Most applications will experience resonance-free performance of <0.5dB thru at least 26.5GHz. Insertion loss at higher frequencies is in part dependent on installation parameters.

Custom designs (including those to match wider strip lines) are available upon request. Wire bondable designs for applications where strip line matching is not imperative, are also available. More information can be obtained by contacting the factory or your local AVX representative.

The assemblies are especially robust and capable of exceeding Resistance to Flexure Stress tests normally applied to MLC's. The high temperature connection between the MLC and SLC results in a joint whose re-melt temperature will withstand all normal soldering processes without deterioration. In applications where SN63 is used, the SLC termination will contribute <1% Au to the resultant joint—thereby, eliminating possible solder embrittlement problems.

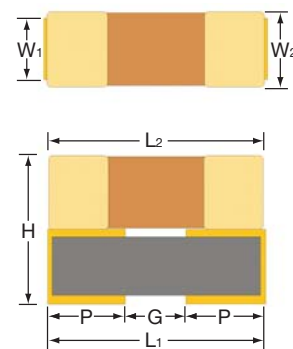

ELECTRICAL SPECIFICATIONS

PART NUMBER	GZ0415ZD104M600ZNW	GZ0402ZD104M800ZNW	GZ06023C104M800ZNW
ELECTRICAL DATA			
Capacitance - MLC	0.1 μ F \pm 20%		
Capacitance - SLC	60 pF +80%, -20%	80 pF +80%, -20%	
Voltage Rating	16 VDC @ +85°C; 10 VDC @ +125°C		25 VDC @ 125°C
Insulation Resistance	10,000 MegOhms @ 25°C; 1,000 MegOhms @ 125°C		
Operating Temp Range	-55°C to +125°C		
Temp Coefficient	X5R to +85°C; X7S to +125°C		X7R to +125°C

DIMENSIONS – Inches (Millimeters)			
L1 (SLC Length)	.043 \pm .003 (1.092 \pm .076)		.063 \pm .003 (1.600 \pm .076)
L2 (MLC Length)	.040 \pm .004 (1.016 \pm .102)		.063 \pm .003 (1.600 \pm .076)
W1 (SLC Width)	.015 \pm .002 (.381 \pm .051)	.020 \pm .002 (.508 \pm .051)	
W2 (MLC Max Width)	.024 (.061)		.036 (.914)
H (Overall Height)	.046 (1.168) Max / .042 (1.067) Typ		.056 (1.422) Max / .053 (1.346) Typ
G (Gap)	.010 (.254) Typ		.020 (.508) Typ

SLC PAD SIZE (P x W1 – Typ of 2)	.015 \pm .003 x .015 \pm .002 (.381 \pm .076 x .381 \pm .051)	.015 \pm .003 x .020 \pm .002 (.381 \pm .076 x .508 \pm .051)	.020 \pm .003 x .022 \pm .002 (.508 \pm .076 x .559 \pm .051)
---	--	--	--

MTG FOOTPRINT (L1 x W1)	.043 \pm .003 x .015 \pm .002 (1.092 \pm .076 x .381 \pm .051)	.043 \pm .003 x .020 \pm .002 (1.092 \pm .076 x .508 \pm .051)	.063 \pm .003 x .022 \pm .002 (1.600 \pm .076 x .559 \pm .051)
--------------------------------	---	---	---

TERMINATIONS	MLC – Ni-Au (plated); SLC – Ti/W-Ni-Au (sputtered)		
---------------------	--	--	--

ATTACHMENT	Conductive Epoxy and Sn/Pb, Au/Sn & SAC Alloys		
-------------------	--	--	--

PACKAGING	Waffle Pack (192 per) - 7" 8mm Tape & Reel Available (2000 pieces minimum)		
------------------	--	--	--

Maxi Broadband DC Block to 40GHz

HOW TO ORDER

GZ	0402	Z	D	104	M	800	Z	N	W or T
Style	Mounting Footprint	Voltage Rating Z = 10V Y = 16V 3 = 25V	MLC Dielectric X7R = C X5R = D	MLC Capacitance EIA Cap Code in pF	MLC Tolerance M = ±20%	SLC Capacitance EIA Cap Code in pF	SLC Tolerance Z = +80% -20%	SLC Termination Ti/W-Ni-Au	Packaging Code W = Waffle Pack T = Tape & 7" Reel

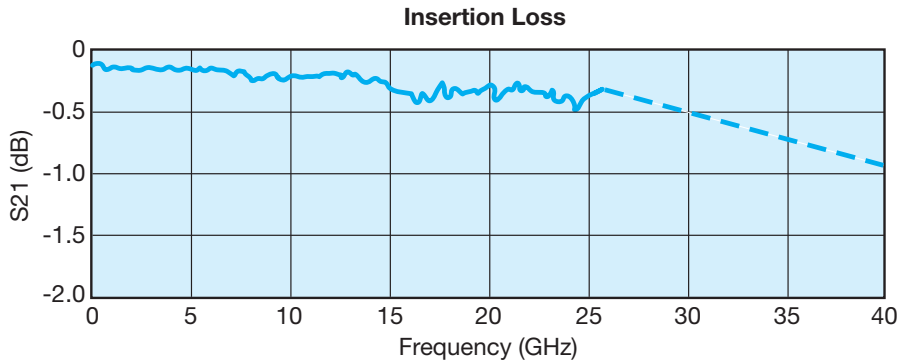
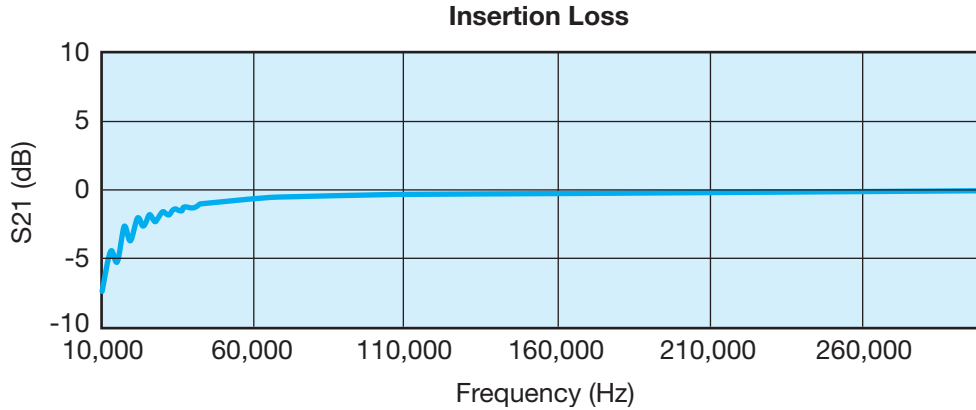

Typical performance on 10 mil alumina, 20 mil trace and 10 mil gap

ULTRA MAXI Series

The Ultra Maxi Series is the latest addition to the AVX family of proprietary high k, intergranular barrier layer dielectric systems. This series is similar to our Maxi and Maxi+ product offerings, but with the notable difference that the dielectric constant has been increased to 60,000 – double the previous high for our industry leading GBLB formulations.

These new Single Layer Ceramic Capacitors – available in voltage ratings of 6.3, 16 and 25 VDC – set a new standard for circuit miniaturization. On average, the required board mounting area will be reduced by approximately two-thirds when compared to an equivalent capacitance value in our Maxi+ series. The Ultra Maxi Series offers an ideal solution for broadband bypass applications where high performance and the smallest footprint are the primary considerations.

The Ultra Maxi Series is RoHS compliant – as are all AVX SLC products. Terminations (Au over Ti/W) provide an excellent wire bonding surface and are compatible with conductive epoxy or Au/Sn eutectic solder attach.

Samples and custom configurations are available on request.

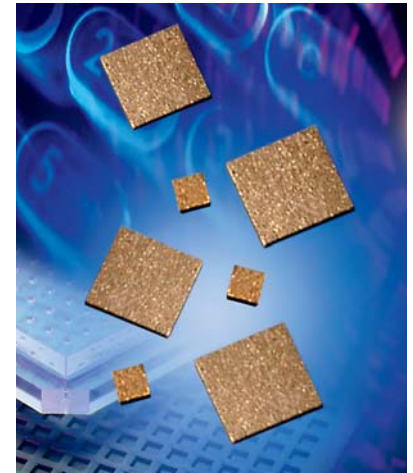

Style	Length x Width millimeters (inches)	Capacitance (pF)		
		6.3 VDC	16 VDC	25 VDC
GD10	.254 x .254 (.010 x .010)	300	220	180
GD15	.381 x .381 (.015 x .015)	650	500	400
GD20	.508 x .508 (.020 x .020)	1200	900	740
GD25	.635 x .635 (.025 x .025)	1800	1400	1200
GD30	.762 x .762 (.030 x .030)	2700	2000	1600
GD35	.889 x .889 (.035 x .035)	3600	2700	2200
GD40	1.016 x 1.016 (.040 x .040)	4800	3700	3000
GD45	1.143 x 1.143 (.045 x .045)	6000	4600	3800
GD50	1.270 x 1.270 (.050 x .050)	7500	5700	4700
GD55	1.397 x 1.397 (.055 x .055)	10000	7500	6200
Thickness:		.102 - .140 (.0040 - .0055)		.127 - .152 (.005 - .006)
L & W Tolerance:		±.051 (±.002)		

ELECTRICAL CHARACTERISTICS

- Dielectric Withstanding Voltage:** 2.5 x Rated Voltage
- IR @ Rated Voltage @ 25°C:** 10,000 Megohms
- IR @ Rated Voltage @ 125°C:** 500 Megohms
- Dissipation Factor @ 1 KHz:** 2.5% Max
- Temperature Coefficient:** ±15% from -55° to +125°C

NOTE: All GD styles packaged 400 pieces per except GD15 which is packaged 484 per

HOW TO ORDER

GD	25	6	0	182	Z	A	W
Style	L/W (mils)	Voltage 6.3V = 6 16V = Y 25V = 3	Dielectric 0 = Ultra Maxi	Capacitance Code (pF)	Capacitance Tolerance M = ±20% Z = +80%, -20%	Termination (Sputtered) Au (100 μ-in) over Ti/W (1000Å)	Packaging Code Antistatic Waffle Pack

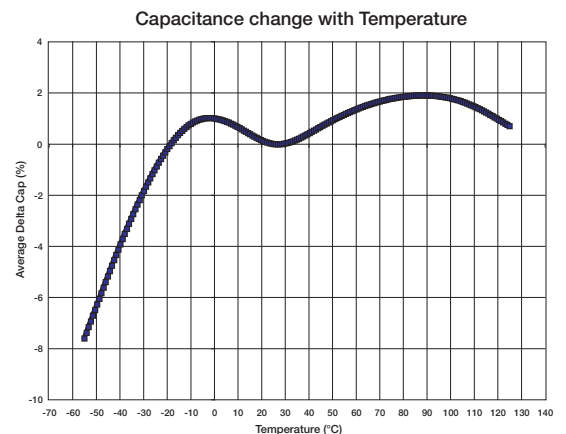

Metal Oxide Semiconductor Single Layer Capacitor

BENEFITS

- Very Stable Capacitance
- GHz Operation
- Customizable
- Small Size

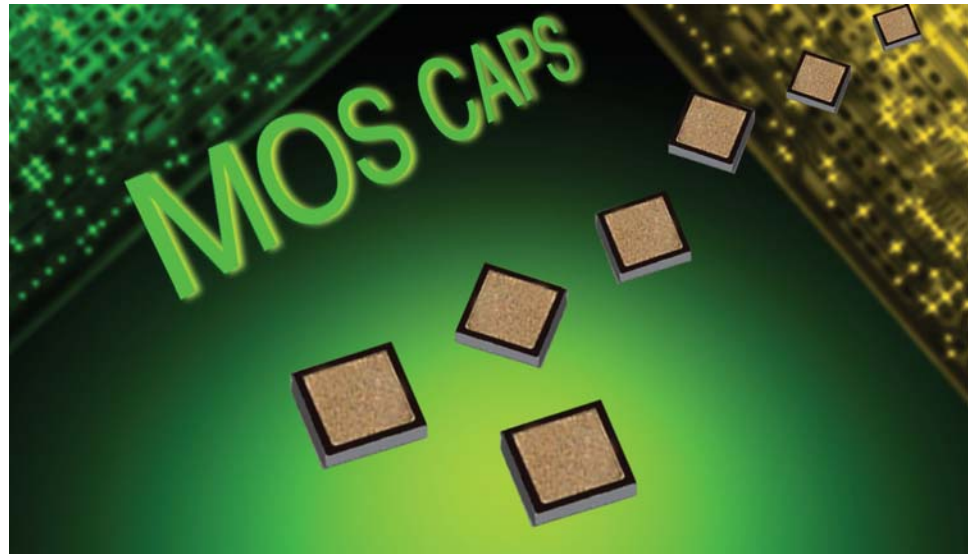

GENERAL INFORMATION

For applications in RF, microwave, and GHz ranges, AVX now offers MOS Capacitors. MOS Capacitors are Single Layer Capacitors (SLCs) that use Silicon dioxide to produce small, high Q, temperature stable, high break down voltage, low leakage capacitors. To ease assembly,

AVX offers a wide range of termination styles for epoxy or solder die attach and subsequent Gold or Aluminum wire thermosonic and ultrasonic bonding. Custom applications and designs are welcome. Please contact your local representative.

HOW TO ORDER

MS T	20 T	3 T	S T	100 T	M T	3893 T	W T
Series Code Metal on Silicon	Case Size Square Size in mils 20, 30, 40 OS = Special Order Please supply design	Working Voltage Z = 10 WVDC 3 = 25 WVDC	Dielectric Code S = SiO ₂	Capacitance EIA Capacitance Code in pF First two digits = significant figures or R for decimal place Third digit = number of zeros or after "R" significant figures	Capacitance Tolerance J = ±5% K = ±10% M = ±20%	Termination Code 1st position top layer 2nd position top bonding layer 3rd position bottom bonding layer 4th position bottom layer 1=Al, 2=Cr, 3=Au, 4=Ni, 5=Pd, 6=Ta, 7=TaN, 8=TiW, 9=TiW/Ni OSOS=Special Order Please Supply Design	Packaging Code W = Antistatic Waffle Pack

TEST METHODS

MIL Reference	Parameter	Method or Paragraph	Comment
MIL-STD-883	Bond Strength	2011.7	For TiW / Ni / Au
MIL-STD-883	Shear Strength	2019	
MIL-STD-202	Solderability	208	
MIL-STD-202	Thermal Shock	107	
MIL-STD-202	Life	108	
MIL-STD-202	Load Humidity (THB)	103 @ rated VDC	

Metal Oxide Semiconductor Single Layer Capacitor

MOS CAPACITOR SAMPLE MATRIX 50V RATED

Construction: Au / TiW / SiO₂ / Si-n* / TiW / Ni / Au, typically 0.125 x 0.125 mm bond areas
 Nominal bond pad thickness 15 kÅ; back side Au 3 kÅ minimum

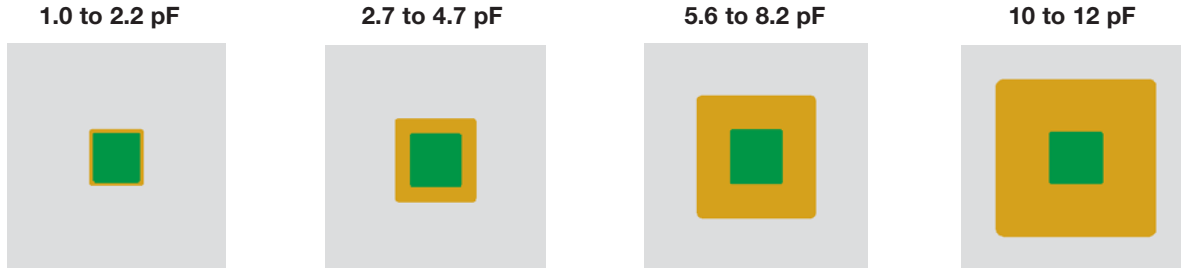

* Standard Offering Die
 Thickness 0.152 ±0.012mm (6 ±0.5 mils)

Cap (pF)	Pad (mm)	Pad (mils)	Die LxW (mm) ±50 µm	Die LxW (mils) ±2 mils
1.5	0.133	5.2	0.508 x 0.508	20 x 20
2.2	0.161	6.3	0.508 x 0.508	20 x 20
3.3	0.197	7.7	0.508 x 0.508	20 x 20
4.7	0.235	9.3	0.508 x 0.508	20 x 20
6.8	0.282	11.1	0.508 x 0.508	20 x 20
8.2	0.310	12.2	0.508 x 0.508	20 x 20
12	0.375	14.8	0.508 x 0.508	20 x 20
18	0.460	18.1	0.762 x 0.762	30 x 30
27	0.563	22.2	0.762 x 0.762	30 x 30
39	0.676	26.6	1.016 x 1.016	40 x 40
56	0.810	31.9	1.016 x 1.016	40 x 40

Note: Other capacitance values, L x W, and thickness available as special orders.



Metal Oxide Semiconductor Single Layer Capacitor

Group I (100%)				
Inspection	Test Conditions	Passing	Qty.	Failures
Cap / DF	1 MHz, 1 VAC	Cap sort: 5, 10, 20%	100%	Sort
		DF 0.1% maximum		
IR	Rated voltage, 30 second charge time	10 ⁹ Ohm minimum	100%	Sort
High Pot / DW	1.5x rated voltage	No breakdown	50	100% Sort on 1
Q	1 MHz, 50mV	1000, minutes	25	100% Sort on 1
Group II (25 pieces)				
Temp coefficient	-55 to +150°C	+50ppm / degree C	25	1
Group III (36 pieces)				
Solderability	MIL-STD-202, Method 208	No physical damage (Ref: MIL-C-49464A)	12	1
Bond Strength	MIL-STD-883, Method 2011	6 grams, gold wire 1 mil	12	
Die Shear	MIL-STD-883, Method 2019		12	
Group IV (125 pieces)				
Life	MIL-STD-202, Method 108; 2x rated; no failures to 1000 hours	No mechanical damage; IR above minimum; $\Delta cap < 0.5\%$ or 0.5 pF	125	1
Group V (80 pieces)				
Low Voltage Humidity	85% / 85%, rated voltage; no failures 1000 hours	No mechanical damage; IR above minimum; $\Delta cap < 0.5\%$ or 0.5 pF	80	1

Metal Oxide Semiconductor Single Layer Capacitor

ESAMPLE S21 AND Q VERSUS FREQUENCY:

Typical MOS Caps: 50MHz-25GHz
Au/TaN bond pad, Cr/Au back side

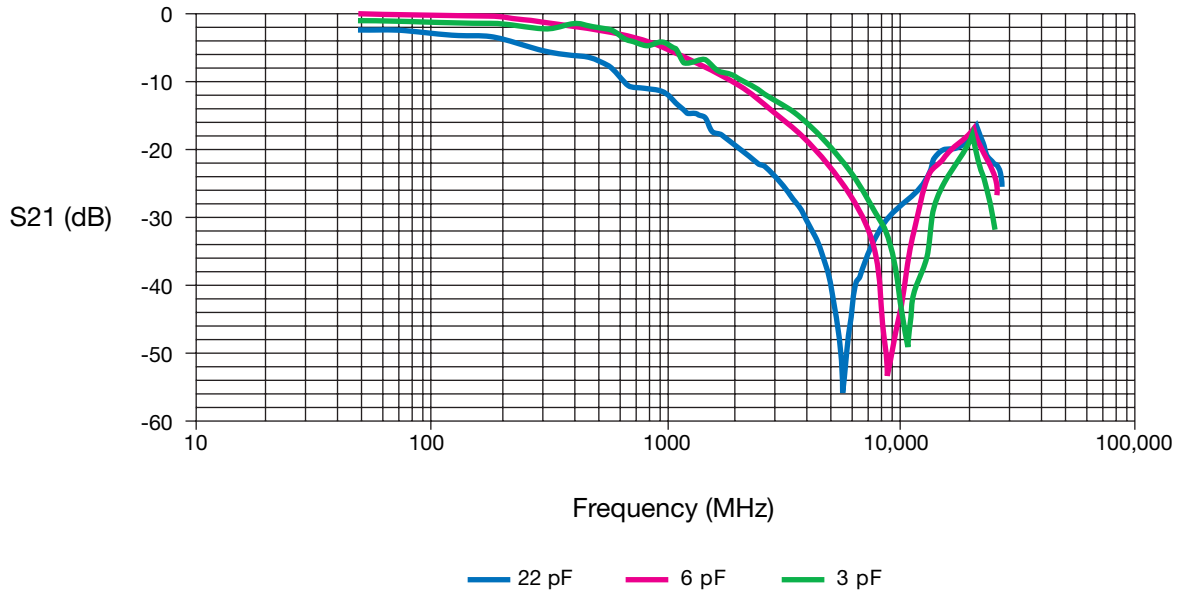

22pF Q vs. Frequency

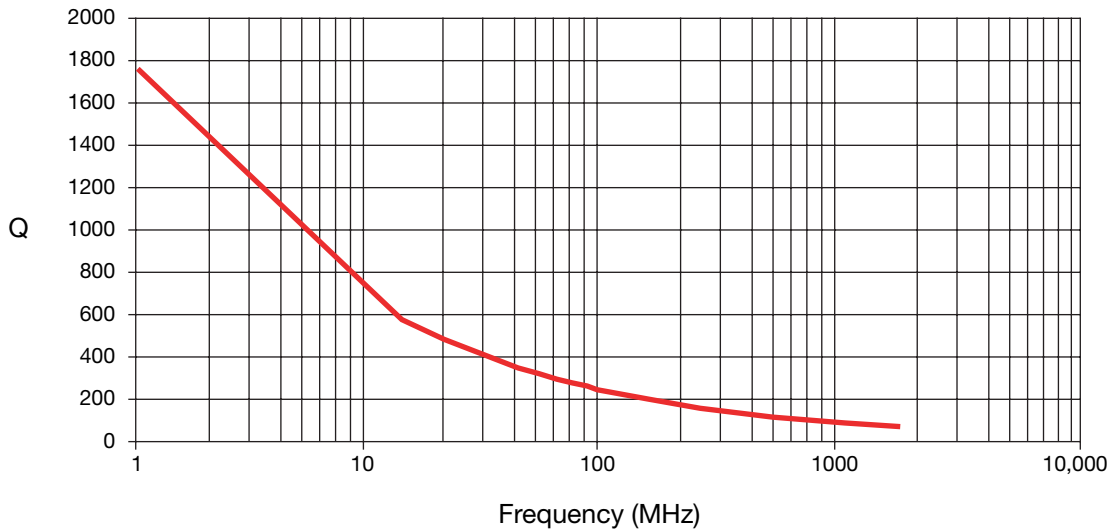

Introduction to Microwave Capacitors

Microwave Capacitors in MICs

Typical Microwave Circuit Applications

Microwave MLC, SLC, or Thin-Film capacitor applications in MIC circuits can be grouped into the following categories:

- DC Block (in series with an MIC transmission line)
- RF Bypass (in shunt with transmission lines)
- Source Bypass (in shunt with active device)
- Impedance Matching

This chapter discusses these applications and the performance parameters of microwave capacitors affecting these applications.

DC Block

In the DC block application, the chip capacitor is placed in series with the transmission line to prevent the DC voltage from one circuit from affecting another circuit.

The capacitance is chosen so that the reactance is only a fraction of an ohm at the lowest microwave frequency of interest.

The largest value capacitor is used as long as the self-resonant frequency is still much higher than the highest frequency of interest.

RF Bypass

The RF bypass application is used to effectively short out the RF to ground. The capacitor value is also picked to be as large as possible without approaching the self-resonance of the capacitor.

Source Bypass

The source bypass application is the same as the RF bypass except the capacitor is used in conjunction with an active device.

In this application the chip capacitor is butted up to the source of the microwave FET device mounted on the MIC circuit. This is done to minimize the length of the wire bond from the source of the FET to the capacitor. The shorter the wire bond, the lower the corresponding inductance.

The top side of the capacitor should be completely metalized so that the bond wire from the FET to the edge of the capacitor is minimized.

The height of the capacitor must be less than or equal to the height of the FET, usually about 0.005 inches. If the capacitor is higher than the FET, the capacitor will interfere with the bonding tool when wire bonding to the FET.

Impedance Matching

The impedance matching application is to use the chip capacitor to provide the required reactance at a specific point in the circuit.

This is usually the most critical application in terms of the capacitor maintaining a tight tolerance over temperature and from unit-to-unit.

The other applications only require that the capacitance for the DC block and RF bypass maintains a low reactance and the tolerance can be as much as $\pm 50\%$. Whereas the impedance matching function often requires $\pm 1\%$ tolerance.

In general, microwave capacitors should have the following properties:

- Low-loss
- Operate very much below the self-resonant frequency
- The power handling capability should be commensurate with the expected power performance of the circuit
- Capable of wire bonding and gap welding
- Low variation of capacitance over temperature
- Low unit-to-unit variations in capacitance
- Low dimensional variations from unit-to-unit

Typical SLC applications in MIC circuits are shown in:

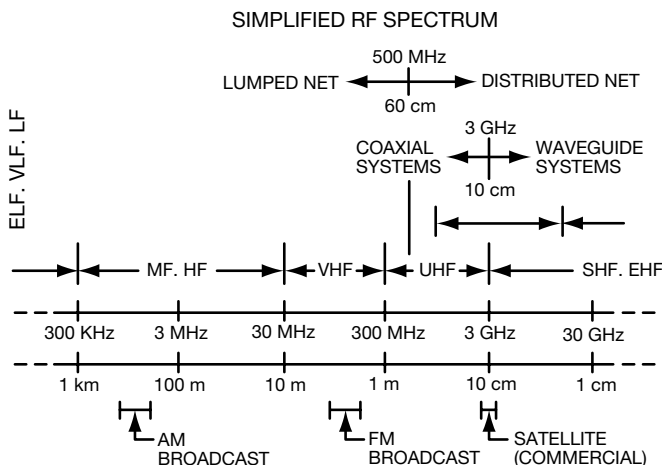

Figure 1

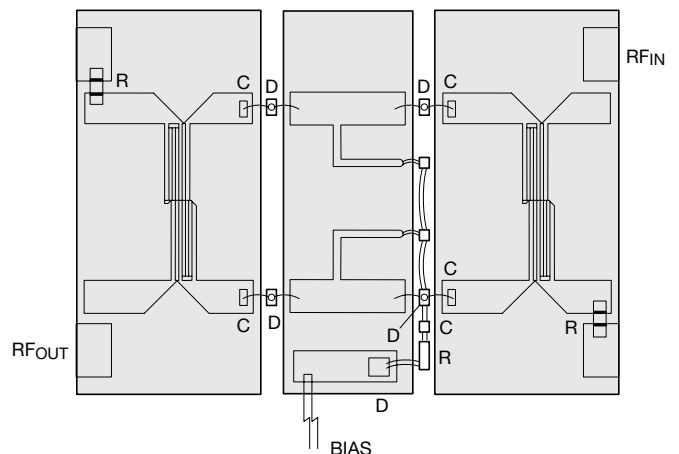

Figure 2. Typical MIC Microwave Attenuator Hybrid with SLC's. "C" indicates SLC locations.

Introduction to Microwave Capacitors

Microwave Parameters

Scattering Parameters

Generally, transmission and reflections coefficient measurements completely characterize any black box or network. Transmission and reflections parameters — attenuation (gain), phase shift, and complex impedance — can be described in terms of a set of linear parameters called “scattering” or “s” parameters. Knowing these characteristic parameters, one can predict the response of cascaded or parallel networks accurately. Unlike y or h parameters which require short circuit and open circuit terminations, “s” parameters are determined with the input and output ports terminated in the characteristic impedance of the transmission line which is a much more practical condition to obtain at RF and microwave frequencies.

To summarize, “s” parameters are more useful at microwave frequencies because:

1. Equipment to measure total voltage and total currents at the ports of the networks is not readily available.
2. Short and open circuits are difficult to achieve over a broad band of frequencies because of lead inductance and capacitance. Furthermore, these measurements typically require tuning stubs separately adjusted at each frequency to reflect short and open circuits to the device terminals, and this makes the process inconvenient and tedious.
3. Active devices such as transistors and negative resistance diodes are very often not short- or open-circuit stable.

There are four scattering parameters for a two-port network: S11, S12, S21, and S22.

S11 is the reflection coefficient at the input port with the output port terminated in a 50 ohm load.

S12 is the reverse transmission coefficient in a 50 ohm system.

S21 is the forward transmission coefficient in a 50 ohm system.

S22 is the reflection coefficient at the output port with the input port terminated into a 50 ohm load.

The reflection coefficients can be directly related to the impedance of the device by the equation:

$$\text{Eq.1. } Z_{IN}/Z_0 = (1 + S_{11})/(1 - S_{11})$$

where Z_{IN} = input impedance
 Z_0 = characteristic impedance of the transmission line

This equation also defines the Smith Chart.

Return Loss

Return loss is the ratio of the incident power to the reflected power at a point on the transmission line and is expressed in decibels. The reflected power from a discontinuity is expressed as a certain number of decibels below the incident power upon the discontinuity. It can be shown that

return loss can be related to the reflection coefficient and VSWR:

$$\text{Eq. 2. } RL \text{ (dB)} = 10 * \log (P_{inc}/P_{ref}) \\ = 20 * \log (E_{inc}/E_{ref}) = 20 * \log (1/Rho)$$

$$\text{Eq. 3. } Rho = (VSWR - 1)/(VSWR + 1)$$

$$\text{Eq. 4. } VSWR = (1 + Rho)/(1 - Rho)$$

where Rho = reflection coefficient

RL = return loss

Pinc = power incident

Pref = power reflected

Einc = voltage incident

Eref = voltage reflected

VSWR = voltage standing wave ratio

By the above equation, when the reflection coefficient is 1, the return loss is zero. In this case, no signal is lost and all the signal incident upon the discontinuity was returned to the source. As the reflection coefficient approaches zero, the return loss approaches infinity. That is, the more perfect the load, the less the reflection from that load.

The return loss can be improved by an attenuator.

Assume that we connect a perfectly matched 3 dB attenuator into a short circuit as shown in Figure 3.

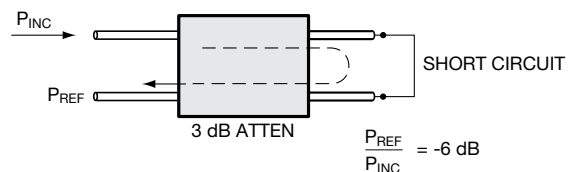

Figure 3

The indicated 100 mw is decreased to 50 mw at the output of the 3 dB attenuator. This 50 mw is reflected from the short circuit back through the attenuator in the reverse direction and one-half of this reflected power is lost in the 3 dB attenuator. The reflected power at the input is 25 mw. Notice the return loss is equal to twice the attenuation because it is the “round trip” loss. This example shows that VSWR is decreased when attenuation exists on a transmission line and also that a high VSWR can be decreased by placing an attenuator in the line.

Mismatch Loss

Mismatch loss is a measure of power loss caused by reflection. It is the ratio of incident power to the difference between incident and reflected power and is expressed in dBs as follows:

$$\text{Eq. 5. } \text{Mismatch loss (dB)} = 10 * \log [P_{inc}/(P_{inc} - P_{ref})] \\ = 10 * \log [1/(1-Rho = 2)]$$

Introduction to Microwave Capacitors

Microwave Parameters

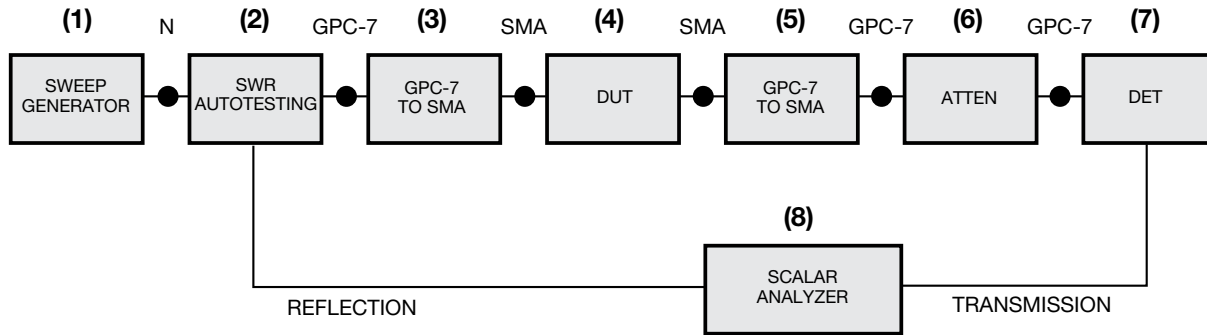

- (1) Wiltron 6647A 10MHz - 18GHz sweepers
- (2) Wiltron 560-97-A50
- (3) OSM 2082-2700-00
- (4) Device under test
- (5) OSM 2082-2700-00
- (6) OSM 7082-6193-10
- (7) Wiltron 560-7A50

- Test set-up for:
- (1) Insertion loss
 - (2) VSWR

Figure 4

The mismatch loss for various values of VSWR is tabulated as follows:

Table I

VSWR	Mismatch Loss
1.00	0.00 dB
1.20	0.04 dB
1.40	0.12 dB
1.50	0.18 dB
1.70	0.30 dB
2.00	0.51 dB
2.50	0.88 dB
3.00	1.25 dB

Insertion Loss Measurement

Insertion loss is measured by the substitution method. The insertion loss of the measurement system is used as a reference. Then the DUT (Device Under Test) is inserted into the setup and the new insertion loss is measured. The difference between the two losses is the insertion loss of the DUT.

The insertion loss is measured using the test setup as shown in Figure 5.

In order to accurately measure the insertion loss, source VSWR and load VSWR must be extremely low. It is assumed during calibration (loss of the measurement system with the DUT removed from the test setup) that the VSWR of the generator and the load does not contribute any mismatch losses. As discussed in the section on mismatch loss, any VSWR above 1.2:1 may cause a minimum error of 0.04 dB. In addition, the two VSWRs may be additive or subtractive depending on the phasing of the reflections. For example, source and load VSWRs of 1.2:1 can add to create an error of 0.08 dB. The mismatches usually exhibit themselves as amplitude ripple as a function of frequency. It is important when measuring low insertion losses that precautions are taken to ensure low source and load VSWRs and to keep the

mismatch losses due to the two VSWRs to a small fraction of the expected insertion loss of the DUT.

In using the scalar network analyzer it is a temptation to normalize the amplitude response regardless what the actual response is during calibration. It is advisable to eliminate the amplitude ripple first before normalizing the scalar analyzer. One way is to make use of the fact that VSWRs can be improved by the use of matched attenuators. Often, 10 dB attenuators are placed before and after the DUT to provide a minimum of 20 dB return loss which corresponds to source and load VSWRs of less than 1.20:1. This will reduce the uncertainties due to mismatch losses to less than 0.02 dB.

Return Loss Measurement

The return loss is measured by the following method: The test port is terminated by a short circuit so that all the incident power is reflected. A detector on the bridge measures this power and this power is used as the reference for the incident power. The test port is then terminated by the DUT and the reflected power now measured. The difference between the power levels is the return loss.

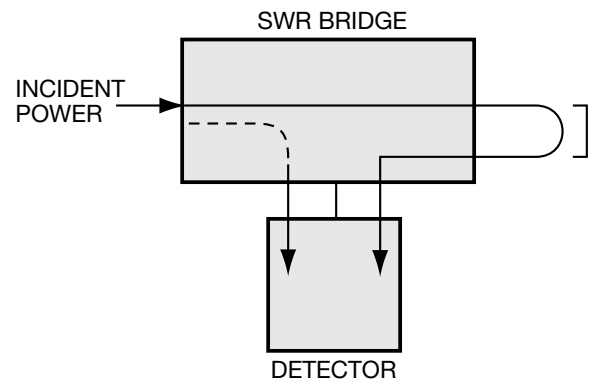
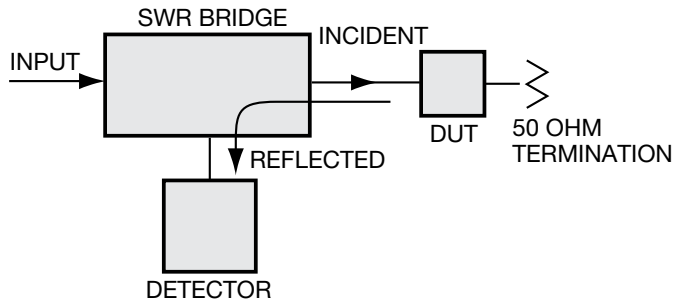

Figure 5. Return Loss Measurement: Establishing a Reference

Introduction to Microwave Capacitors

Microwave Parameters



DUT IN PLACE

Figure 6

- All incident power is reflected at the short circuit.
- The detector measures the reflected power.
- An SWR bridge usually has a directivity of 35 to 40 dB. In other words, only a minute fraction of the incident power reaches the detector (the dotted line path) that is not reflected off the short circuit.
- The DUT is substituted for the short circuit and the opposite port is terminated by a matched termination (50 ohms).
- The reflected power depends on the DUT and is sensed by the detector.
- The return loss is the difference between this reflected power and that measured with a reference short circuit.
- A significant improvement in calibrating a 0 dB return loss reference by averaging the short circuit and open circuit reflected powers.
- The dotted line in the figure below shows the reflections due to an open circuit.
- The solid line in the figure below shows the reflections due to a short circuit.
- Since the phase difference between short circuit and open circuit is 180 degrees.
- By taking the average between these two voltages, the actual full reflection is very closely approximated.

AVERAGING THE SHORT CIRCUIT AND OPEN CIRCUIT REFERENCES FOR HIGHER ACCURACY

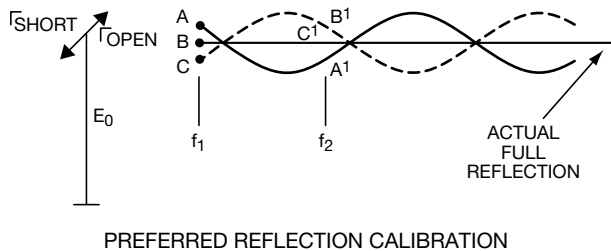

Figure 7

Note that the insertion loss and return loss can be measured simultaneously by using the dual trace feature of the Wiltron Scalar Analyzer. Furthermore, the two measurements can be done by using a controller such as the HP85 computer for semi-automatic testing.

The calibration for 0 dB return loss can be improved by averaging the short circuit and open circuit reflected powers. Since the phase difference is 180 degrees, the average closely approximates the actual full reflection.

Decibels

The decibel, abbreviated “dB,” is one-tenth of the international transmission unit known as the “bel.” The origin of the bel is the logarithm to the base 10 of the power ratio. It is the power to which the number 10 must be raised in order to equal the given number. The number 10 is raised to the second power, or squared, in order to get 100. Therefore, the log of 100 is 2.

The decibel is expressed mathematically by the equation:

Eq. 6 $dB = 10 * \log (P_2/P_1)$
 $P_2 = \text{larger power}$
 $P_1 = \text{lower power}$

The use of log tables can be avoided in practical applications where exact values of the power are not required. One only needs to know that a factor of 2 is equal to 3 dB and a factor of 10 is equal to 10 dB and the rest of the conversions are derived from these two relationships. The use of dBs reduces multiplication into an addition. For example:

3dB =	2
6dB = 2 x 2 =	4
9dB = 2 x 2 x 2 =	8
10dB =	10
20dB =	100

The technique is based on the fact that 3, 6, and/or 9 dB can be added or subtracted (in some combination) to any decibel value. Adding or subtracting 10 to a decibel value simply multiplies or divides the number by ten. Examples:

1. 17dB = 20dB - 3dB
 20dB is 10dB + 10dB or is equal to 100.
 3dB is equal to 2

Therefore, 20 dB - 3dB = 100/2 = 50

2. 36dB = 30dB + 6dB
 1000 x 4 = 4000

Decibel:

The decibel is not a unit of power but merely is a logarithmic expression of a ratio of two numbers. The unit of power may be expressed in terms of dBm, where “m” is the unit, meaning above or below one milliwatt. Since one mw is neither above nor below 1 mw, 1 mw = 0 dBm.

Nepers:

An alternate unit called the neper is defined in terms of the logarithm to the base “e.” $e = 2.718$.

1 neper = 8.686dB

1dB = 0.1151 neper



Introduction to Microwave Capacitors

Electrical Model

Capacitance

Microwave chip capacitors, although closely approximating an ideal capacitor, nonetheless also contain parasitic elements that are important at microwave frequencies. The equivalent circuit is shown below:

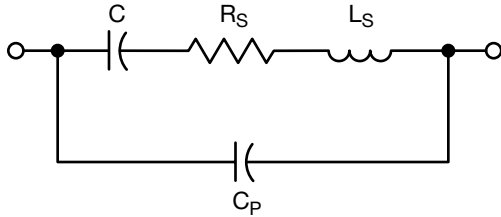

Figure 8. Equivalent Circuit of a Microwave Capacitor

- where, C = desired capacitance
- L_s = parasitic series inductance
- R_s = series resistance
- C_p = parasitic parallel capacitance,

R_p, the parallel resistance is not shown as it is of concern only at dc and low frequencies.

The primary capacitance, C, is typically determined by measurement at 1 MHz where the effects of R_s, L_s, and C_p become negligible compared to the reactance of C. The value of C determined at this low frequency is also valid at microwave frequencies when the dielectric constant has a very low variation versus frequency, as is typical in the modern dielectrics employed in microwave capacitors.

The equivalent impedance of the capacitor at any frequency is:

$$\text{Eq. 7. } Z_s = \frac{1}{sC_p + \frac{1}{R_s + sL_s + \frac{1/s}{C_s}}}$$

where $s = j2\pi f$, f = frequency

Series and Parallel Resonance

Ideally, the impedance magnitude of a series mounted capacitor will vary monotonically from infinite at dc to zero at infinite frequency. However, the parasitics associated with any capacitor result in a nonideal response.

Figure 9 shows the magnitude, $|Z(f)|$, as a function of frequency.

Figure 10 shows $Z(f)$ on the Smith Chart, which includes magnitude and phase.

Eq. 8. In general, an impedance is represented by $Z=R + j X$. The Smith Chart maps the entire impedance half plane for $R > 0$ into the interior of a unit circle. The Smith Chart is a mapping of the reflection coefficient, S₁₁, of an impedance. $S_{11} = (Z - Z_0) / (Z + Z_0)$. Z₀ is a reference impedance, typically 50 ohms, and is in the center of the chart. The central horizontal axis is for $X = 0$, with $R < 50$ to the left of center, and $R > 50$ to the right of center.

Figures 9 and 10 also show the point of series resonance (LS in series with C), and parallel resonance (LS in parallel with CP).

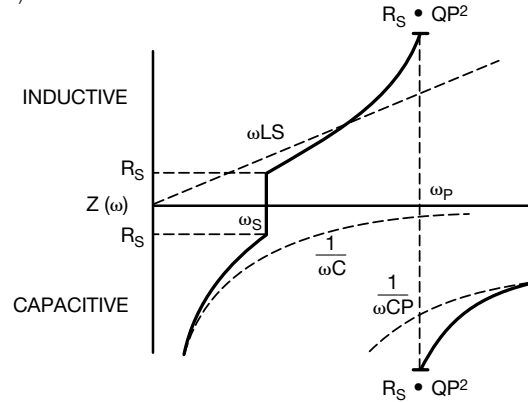

Figure 9. SLC Impedance Magnitude vs. Frequency

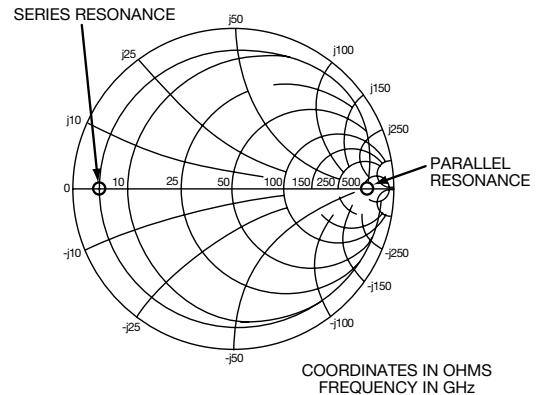

Figure 10. SLC Impedance on Smith Chart

Because there is always some parasitic inductance associated with capacitors, there will be a frequency at which the inductive reactance will equal that of the capacitor. This is known as the series resonant frequency (SRF). At the SRF, the capacitor will appear as a small resistor (R_s). The transmission loss through a series mounted capacitor at its series resonant frequency will be low.

At frequencies above the SRF, the capacitor begins to act like an inductor.

When used as a DC block, the capacitor will begin to exhibit gradually higher insertion loss above the SRF. In other words, the capacitor will cause a high frequency rolloff of its transmission amplitude response.

When used as an RF bypass, as for the source of an FET, the inductance will cause the FET to become unstable which can cause oscillations or undesirable effects on the gain response of the FET amplifier.

Beyond the SRF, there is a frequency called the parallel resonant frequency (PRF). This occurs when the reactance of the series inductor equals that of the parallel capacitor.



Introduction to Microwave Capacitors

Electrical Model

At this parallel resonant frequency, the capacitor will appear as a large resistor whose value is RPRF defined as:

$$\text{Eq. 9. } R_{PRF} = R_s \times Q_p \times Q_p; \text{ where, } Q_p = \frac{1/R_s}{W_p/C_p}$$

$$W_p = 2\pi f_{PRF}$$

The parasitic parallel capacitance is usually very small which results in a parallel resonant frequency that is much higher than the series resonance.

For capacitor usage in RF impedance matching and tuning applications, the maximum practical frequency for use is up to 0.5 times the SRF.

For DC filtering and RF shunting applications, best performance is obtained near the SRF.

At frequencies above the SRF, but below the PRF, the SLC can be used as a low loss inductor with a built-in DC block for bypassing and decoupling.

The series resonant frequency (SRF) of an SLC can be measured by mounting the capacitor in series on a 50 ohm transmission line as shown in Figure 11.

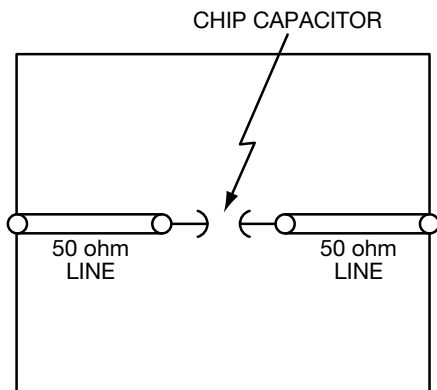

Figure 11

At its series resonant frequency (SRF), the SLC will appear as a small resistance. This measurement can be performed with a vector network analyzer such as the Hewlett Packard 8510. The SRF is at the frequency for which the phase of the input reflection coefficient, S11, is crossing the real axis on the Smith Chart at 180 degrees.

The resonant frequency will be lowered by the inductance associated with the bonding attachment to the capacitor (i.e., bonding wires, ribbons, leads, etc.). The actual resonant frequency of the capacitor by itself can be determined by taking out the effects of the bonding attachment inductance. Using the low frequency measurements of the primary capacitance alone, the inductance of the capacitor can be derived from the resonant frequency. With AVX SLC's, the inductance is low enough so that the practical operating frequencies achieved can be beyond 20 GHz.

Equivalent Series Resistance

The equivalent series resistance is the RS in the electrical model. At the SRF, the ESR can be readily determined on the Smith Chart display of the capacitor's impedance. However, the ESR is not necessarily constant with frequency and its value is typically determined by an insertion loss measurement of the capacitor at the desired frequency.

The insertion loss is a combination of reflective and absorptive components. The absorptive component is the part associated with the value of the ESR (i.e., the loss in RS). Because of the low values of ESR in microwave capacitors (on the order of 0.01 ohm), the insertion loss measurement is very difficult to make, but can be made with a test fixture similar to that shown in Figure 11, but with the input and output 50 ohm impedances transformed down to some more convenient impedance level, Rref, to obtain a more accurate measurement.

When used as a DC block in the transmission line test fixture, the forward transmission coefficient, S21, and the input reflection coefficient, S11, can be measured to determine:

$$\text{Eq. 10. Dissipative Loss. } DL = (1 - |S_{11}|^2) / (|S_{21}|^2)$$

$$\text{Eq. 11. Reflection Loss. } RL = (1 - |S_{11}|^2) \text{ where } S_{11} \text{ and } S_{21} \text{ are expressed as complex phasors.}$$

From the dissipative loss, DL, the ESR can be determined as:

$$\text{Eq. 12. } ESR = R_{ref} * [1 - \sqrt{DL}] / [1 + \sqrt{DL}]$$

The ESR typically increases with operating temperature and self-heating under high power. This increase can be seen directly in the lab by measuring the insertion loss of the capacitor as a function of temperature.

A low ESR is especially necessary in SLC's when used in series with transistors in low noise amplifiers, high gain amplifiers, or high power amplifiers. For example, an ESR of 1 ohm in series with a base input impedance of 1 ohm would result in a serious compromise in amplifier gain and noise figure by up to 3 dB.

Power Rating

The RF power rating of chip capacitors is dependent on:

- Thermal Breakdown
- Voltage Breakdown

Thermal Breakdown

Thermal breakdown is self-heating caused by RF power dissipated in the capacitor.

If the resultant heat generated is greater than what can be conducted away through the leads or other means of heat sinking, the capacitor temperature will rise.

Introduction to Microwave Capacitors

Electrical Model

As the capacitor temperature increases, the dissipation factor and ESR of the capacitor also increase which creates a thermal runaway situation.

The small signal insertion loss is used to determine the percentage of power which is dissipated in the capacitor.

For instance, if the insertion loss is:

- 0.01 dB then .2% of the incident power is lost as heat
- 0.10 dB then 2% of the incident power is lost as heat
- 1.00 dB then 20% of the incident power is lost as heat

The capacitor will heat up according to the amount of power dissipated in the capacitor and the heat sinking provided.

Even very low ESR, 0.01 ohm at 1 GHz, can be significant when passing power through a series mounted capacitor into a typically low impedance bipolar transistor base input with an input impedance of only 1 ohm. If 1% of 10 watts is dissipated in the capacitor, this 100 milliwatt of power causes a very large increase in the capacitor temperature dependent on its heat sinking in the MIC circuit.

Voltage Breakdown

The voltage breakdown also limits the maximum power handling capability of the capacitor.

The voltage breakdown properties of the capacitors is dependent on the following:

- dielectric material
- voids in the material
- form factor
- separation of the electrodes

Most microwave capacitors have a DC voltage rating of 50 VDC. This is much greater than typical DC voltages of 3 to 15 volts present on an MIC circuit.

Dielectric Constant Measurement at Microwave Frequencies

The measurement of dielectric constants at low frequencies is easily done by measuring the capacitance of a substrate of known dimensions and calculating the dielectric constant.

The resonance method is used in measuring dielectric constants at microwave frequencies of metallized ceramic substrates. This is based on the model of the high dielectric constant substrate as a parallel plate dielectrically loaded waveguide resonator. By observing the resonant frequencies and knowing the dimensions of the substrate, the dielectric constant is calculated by fitting the resonances into a table of expected fundamental and higher order modes. This method can be measured by connecting the corners of the substrates to the center conductors of either an APC-7 or Type N connector. The test setup is the same as for insertion loss measurements. This method as described in the literature for an alumina substrate with a dielectric constant of approximately 10 and a substrate height of 0.025 inches can be measured to an accuracy of 2%. The Napoli-Hughes Method uses an open circuit assumption for the unmetallized edges which can be radiative. This inaccuracy is reduced if thinner substrates or if higher dielectric constant substrates are used which will tend to reduce radiation. Higher accuracy can be achieved by metallizing all six sides of the substrate except for the corners where the RF is coupled to the substrate. This method as reported by Howell provided more consistent results.

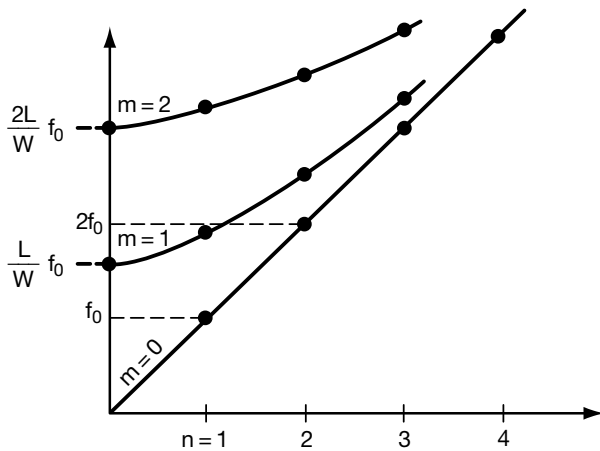

Figure 12

Dispersion Curve of a Rectangular Resonator

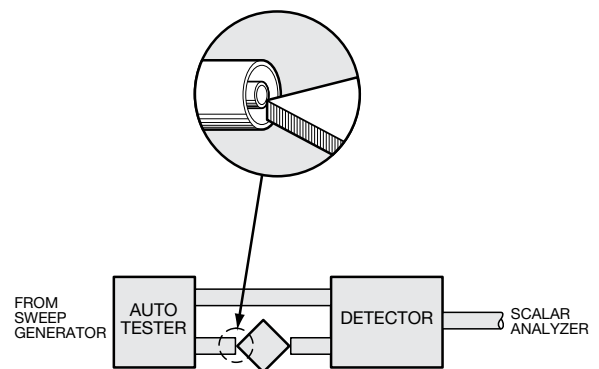

Figure 13

Test Configuration for Resonance Measurements

Introduction to Microwave Capacitors Transmission Lines

Propagation Constant and Characteristic Impedance

The incident waves of voltage and current decrease in magnitude and vary in phase as one goes toward the receiving end of the transmission line which has losses. The propagation constant is a measure of the phase shift and attenuation along the line.

- attenuation per unit length of line is called the attenuation constant. (dB or nepers per unit length)
- phase constant, phase shift per unit length. (radians per unit length)
- angular frequency, $2 * \pi * f$

$(R+j\omega L)$ - complex series impedance per unit length of line.

$(G+j\omega C)$ - complex shunt admittance per unit length of line.

Eq. 13. $Z_0 \rightarrow$ for lossless case: $Z_0 = \sqrt{\frac{L}{C}}$

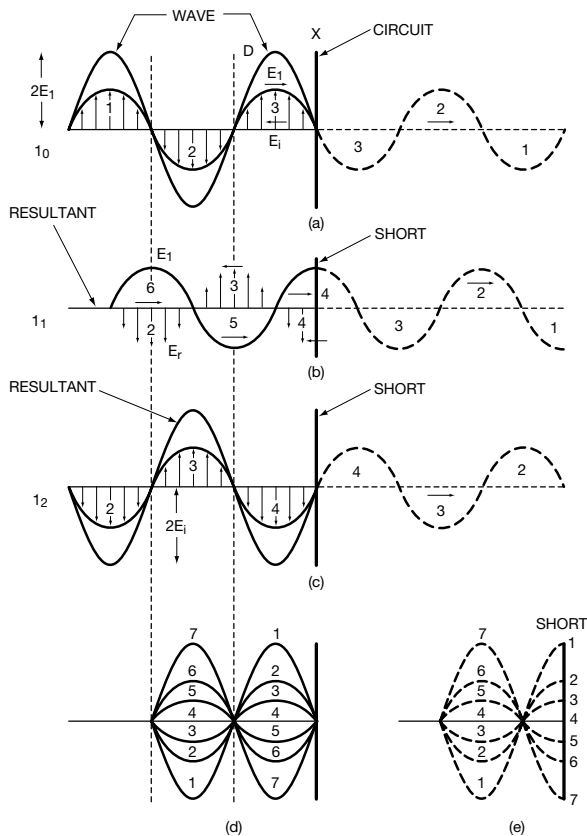

Figure 14

This figure shows generation of standing waves on a shorted transmission line. Dotted lines to the right of the short circuit represent the distance the wave would have traveled in absence of the short. Dotted vectors represent the reflected wave. The heavy solid line represents the vector sum of the incident and reflected waves. (d) and (e) represent instantaneous voltages and currents at different intervals of time.

Standing Waves

Standing waves on the lossless transmission line:

An incident wave will not be reflected if the transmission line is terminated in either matched load or if the transmission line is infinitely long. Otherwise, reflected waves will be present. In other words, any impedance will cause reflections.

Let us consider the case of a lossless transmission line terminated in a short line. In this case all of the incident wave will be reflected. See Figure 15.

The dotted sine wave to the right of the short circuit in the diagram indicates the position and distance the wave would have traveled in the absence of the short circuit. With the short circuit placed at X, the wave travels the same distance back toward the generator. In order to satisfy the boundary conditions, the voltage at the short circuit must be zero at all times. This is accomplished by a reflected wave which is equal in magnitude and reversed in polarity (shown by the superimposed reflected wave and the resultant total voltage on the line). Note that the total voltage is twice the amplitude of the incident voltage at a quarter wavelength back toward the generator and the total voltage is zero at one-half wavelength from the short.

DISTRIBUTED PARAMETER MODEL OF A SECTION OF TRANSMISSION LINES:

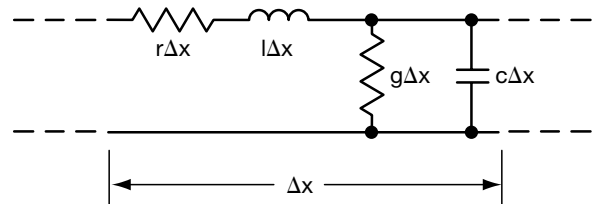

where G = Conductance per unit length
 R = Resistance per unit length
 C = Capacitance per unit length
 L = Inductance per unit length
 ΔX = Incremental length

Figure 15

PURE TRAVELING WAVE

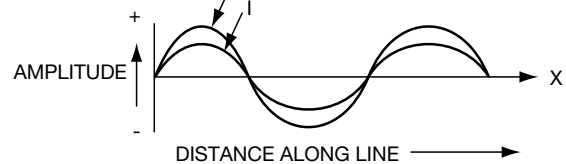

V = Instantaneous voltage
 I = Instantaneous current

Pure traveling waves: V & I in the lossless case are in phase. V & I also reverse polarity every half wavelength.

Figure 16

Introduction to Microwave Capacitors Transmission Lines

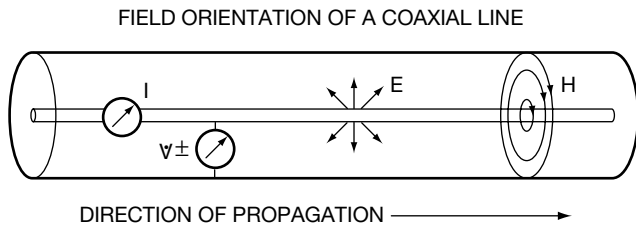

Figure 17

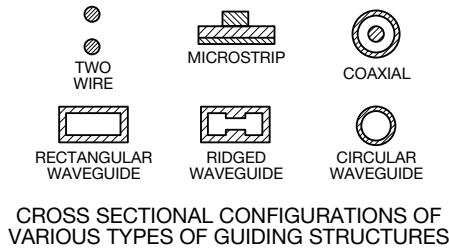

Figure 18

The total voltage pattern is called a standing wave. Standing waves exist as the result of two waves of the same frequency traveling in opposite directions on a transmission line.

The total voltage at any instant has a sine wave distribution along the line with zero voltage at the short and zero points at half wave intervals from the short circuit. The points of zero voltages are called voltage nodes and the points of maximum voltage halfway between these nodes are called antinodes.

Open Circuit:

At a distance of one-quarter wavelength from the short, the voltage is found to be twice the amplitude of the incident voltage, which is equivalent to an open circuit. Therefore, this same distribution would be obtained if an open circuit were placed a quarter wavelength from the short. In the case the first node is located a quarter wavelength from the open and the first antinode is right as the open. The node-to-node spacing remains half wavelength as is the antinode-to-antinode spacing.

Voltage Standing Wave Ratio:

The voltage standing wave ratio is defined as the ratio of the maximum voltage to the minimum voltage on a transmission line. This ratio is most frequently referred to as VSWR (Viswar).

$$\text{Eq. 14. } VSWR = \frac{E_{\max}}{E_{\min}} = \frac{E_i + E_r}{E_i - E_r} = \frac{1 + \text{Rho}}{1 - \text{Rho}}$$

where Rho = reflective coefficient

If the transmission line is terminated in a short or open circuit, the reflected voltage, E_r , is equal to the incident voltage, E_i . From the above equation the reflection coefficient is 1.0, and the VSWR is infinite. If a matched termination is connected to the line, the reflected wave is zero, the reflection coefficient is zero, and the VSWR is zero.



Introduction to Microwave Capacitors

Incorporation of Capacitors into Microwave Integrated Circuit Hybrids

Microwave Integrated Circuit Hybrids

A Microwave Integrated Circuit Hybrid (MIC) is a microwave circuit that uses integrated circuit production techniques involving such factors as thin or thick films, substrates, dielectrics, conductors, resistors, and microstrip lines, to build passive assemblies on a dielectric. Active elements such as microwave diodes and transistors are usually added after photo resist, masking, etching, and deposition processes have been completed. MICs usually are enclosed as shielded microstrip to prevent electromagnetic interference with other components or systems. This section will discuss some of the important characteristics of MICs, such as:

- MIC substrates
- MIC metallization
- MIC components

MIC Substrates:

Microstrip employs circuitry that is large compared to the wavelength of the frequency used with the circuit. For this reason, the etched metal patterns often are distributed circuits with transmission lines etched directly onto the MIC substrate. Figure 19 shows the pertinent dimensional parameters for a microstrip transmission line.

For the current discussion we are most interested in the higher microwave frequencies. The MIC circuit design requires a uniform and predictable substrate characteristic. Several types of substrates in common usage are: alumina, sapphire, quartz, and beryllium oxide. Key requirements for a MIC substrate are that it have:

- Low dielectric loss
- Uniform dielectric constant
- Smooth finish
- Low expansion coefficient

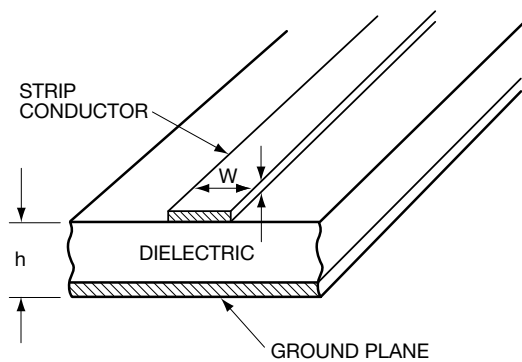

Figure 19. MIC Microstrip Outline

The characteristic impedance of the microstrip line is dependent primarily on the following:

- Width of the conductor: Increase in the width "W" of the conductor will decrease the ZO of the microstrip line.
- Height of the substrate: Increase in the height "H" of the substrate will increase the ZO of the microstrip line.

- Dielectric Constant: Increase of the dielectric constant of the substrate will decrease the ZO of the microstrip line.

Table II shows a brief listing of substrate properties.

Table II

Material	Alumina	Sapphire	Quartz	Beryllium Oxide
Relative Dielectric Constant, E_r	9.8*	11.7	3.8	6.6
Loss Tangent at 10 GHz	0.0001	0.0001	0.0001	0.0001
Thermal Conductivity K, in W/CM/Deg. C	0.3	0.4	0.01	2.5

*Alumina E_r depends on vendor and purity.

The dependence of ZO to the above parameters is as shown:

Eq. 15. $ZO(f) = 377 * H(W)/\text{Sqrt}(E_r)$

where, H = height of the substrate

W = width of the microstrip conductor

E_r = dielectric constant of the substrate

A graph of ZO versus W/H for several values of dielectric constants is shown below:

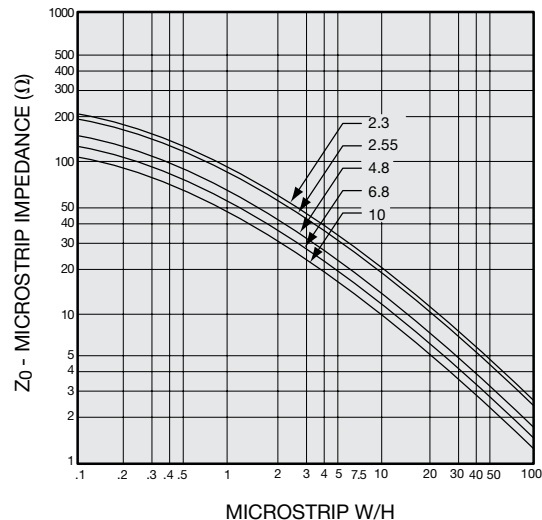

Figure 20

The most popular substrate material is alumina which has a dielectric constant of between 9.6 and 10.0 depending on the vendor and the purity. Other substrates are used where the specified unique properties of the material (beryllia for high power, ferrites for magnetic properties) are demanded by design.



Introduction to Microwave Capacitors

Incorporation of Capacitors into Microwave Integrated Circuit Hybrids

MIC Metallization:

MIC metallization is a thin film of two or more layers of metals. A base metallization layer is deposited onto the substrate, another layer may be optionally deposited on top of this, and then a final gold layer is deposited onto the surface. The base metallization is chosen for its adhesion to the substrate and for compatibility with the next layer.

The base metallization is usually lossy at microwave frequencies. The losses due to this metallization can be kept to a minimum if its thickness does not exceed one "skin depth" of the metal.

Skin effect defines a phenomenon at microwave frequencies where the current travelling along a conductor does not penetrate the conductor but remains on the surface of the conductor. The "skin depth" indicates how far the microwave current will penetrate into the metal. The "skin depth" is smaller as the frequency increases.

By keeping the lossy metallization as thin as possible, more of the microwave current will propagate in the top metallization gold layer and loss is minimized.

Typical metallization schemes used in the industry are:

- Chromium-Gold: Cr-Au
- Nichrome-Gold: NiCr-Au
- Chromium-Copper-Gold: Cr-Cu-Au
- Titanium-Tungsten-Gold: TiW-Au
- Others

MIC Components:

Microstrip has advantages over other microwave circuit topologies in that active semiconductors and passive components can easily be incorporated to make active hybrid circuits. It is possible to mix high and low frequency circuitry to attain a "system-on-a substrate."

Passive Components:

On MIC circuits, the passive components are either distributed or lumped elements. The distributed components are usually realized by etched patterns on the substrate metallization. The lumped components are capacitors, resistors, and inductors; and whenever possible components are derived by etching them directly on the MIC metallization thin film. Chip components are used when they offer advantages such as:

- Component values are beyond that realizable by thin film techniques on the MIC substrates,
- Smaller size is required,
- High power capability is required.

Capacitors, resistors, and inductors are discussed in the following:

Capacitors:

A lumped capacitor can be realized by the parallel gap capacitance of an area of metallization on the top of the substrate to the ground plane. Values of capacitance that can be obtained by this method are usually less than a few picofarads. At microwave frequencies if the capacitor size in any one dimension begins to approach a quarter-wavelength, a resonance will occur.

Large values of capacitance can be achieved with a dielectric constant between the capacitor plates while maintaining the small size required for MIC circuits.

Chip capacitors can be fabricated on substrate with a dielectric constant up to 5000. This higher dielectric constant allows a much smaller size capacitor for a given capacitance value which is a very desirable feature both from the real estate aspect and the self-resonance aspect.

Resistors:

MIC resistors are often realized by using a resistive base layer on the MIC substrate metallization, and by etching the proper pattern to expose the resistive layer in the MIC circuitry.

The exact value of the resistor is determined by:

- resistivity of the resistive base layer, and
- length and width of the resistor.

Thin film resistive base layers are usually the following:

- tantalum nitride, or
- nickel-chrome (nichrome).

When chip resistors are used, they are mounted and connected in the same way as the chip capacitors.

Inductors:

Inductors are often realized by using narrow etched microstrip lines which provides inductance on the order of 1 to 5 nanohenrys.

Higher values up to 50 nanohenrys are obtained by etching a round or square spiral onto the MIC metallization.

Even higher values can be obtained by using wound wire inductors or chip inductors which are wire coils encased in a ceramic.

Both types of discrete inductors are attached to the circuit by the same means as the capacitors.

Introduction to Microwave Capacitors

Incorporation of Capacitors into Microwave Integrated Circuit Hybrids

Active components:

The active devices in the MIC circuit can be made of entirely different materials than the substrates and are usually attached to the substrates by eutectic soldering or conductive epoxy.

Typical active devices on MIC circuits are the following:

- GaAs FETs
- Bipolar Transistors
- Schottky Barrier Diodes
- PIN Diodes
- Various other Semiconductors

The active devices can be either in:

- a plastic or ceramic package with metal leads, or
- chip form.

The packaged devices are commonly used at a lower frequency range than the chip devices since they exhibit more parasitic circuit elements that limit their performance at higher frequency.

The advantages of packaged devices are protection of the devices during transport and mounting, ease of characterization, and ease of mounting onto the MIC circuit.

Chip Component Attach:

The methods of attachment of the chip components to the substrate are usually by:

- eutectic solder die attach, and
- epoxy die attach.

1. Eutectic Die Attach

The eutectic die attach method can be used with several alloys. Eutectic defines the exact alloy combination at which the solidus to liquidus transition takes place at one particular

temperature. Other combinations have transition states with wider temperature ranges. For instance, the eutectic temperature for the following alloys are:

Table III

Alloy	Eutectic Composition	Eutectic Temperature
Gold Germanium	88% Au 12% Ge	356°C
Gold Tin	80% Au 20% Sn	280°C

For best results, the eutectic attach is performed under an inert gas atmosphere, typically nitrogen, to reduce oxidation at high temperatures. The eutectic must be selected so that the die attach operations will not interfere with prior soldering operations and itself will not be disturbed by subsequent process steps. The metallization should be able to undergo 400°C without any blistering or other adhesion degradation.

2. Epoxy Die Attach

The epoxy die attach method uses silver or gold conductive particles in an epoxy. The epoxy for chip attach on MIC circuits is a one-part type which cures at temperatures of from 125°C to 200°C. The curing time is a function of temperature. A cure time of 30 minutes at 150°C is a good compromise for high reliability and a reasonable cure time.

Chip Components Interconnection:

The chip components are interconnected to the MIC circuit by means of:

- wire bonding, and
- miniature parallel gap welding.

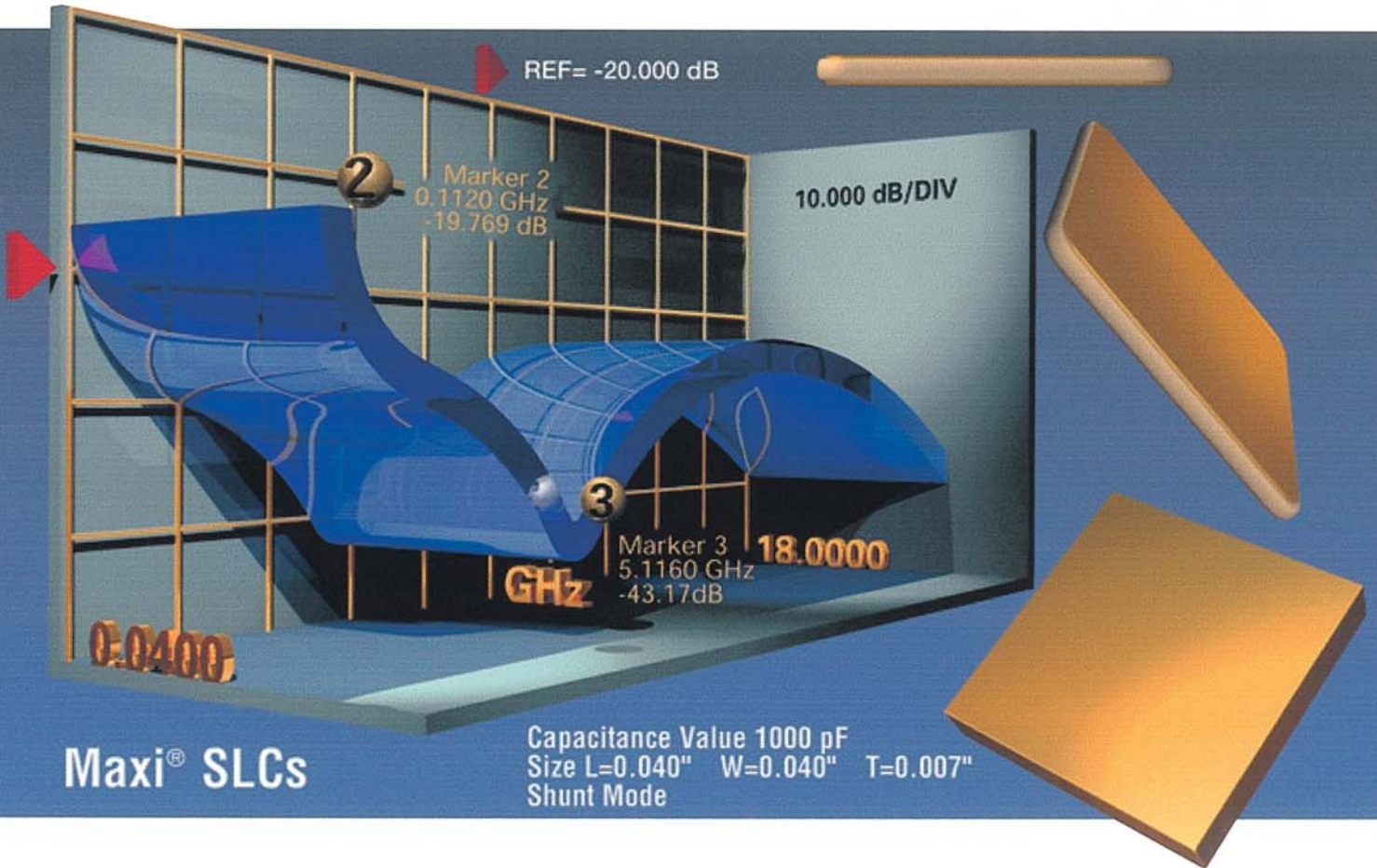

Maxi® SLCs

The numbers speak for themselves

Only AVX's single layer capacitors (SLCs) provide this level of high frequency performance with the industry's highest volumetric efficiency. Constructed with our exclusive Maxi® or Maxi-Plus material, these high frequency capacitors have the built-in characteristics of an extremely broadband by-pass capacitor with the capability to operate in the millimeter bands. Choose SLCs with or without borders in standard sizes ranging from 0.010 inch to 0.090 inch square. Also, AVX offers custom configurations to meet your specific mechanical and electrical applications.

CAPACITANCE CHANGE WITH TEMPERATURE (X7R) <15% FROM -55°C to +125°C

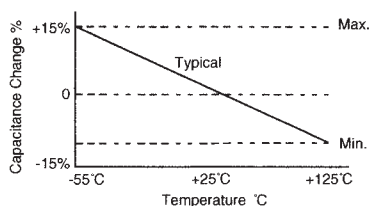

For more information on AVX Maxi® Single Layer Capacitors, visit:

www.avxcorp.com
or call 1-843-946-0414

AMERICAS

**AVX Myrtle Beach, SC
Corporate Offices**
Tel: 843-448-9411
FAX: 843-448-1943

AVX Northwest, WA
Tel: 360-699-8746
FAX: 360-699-8751

AVX North Central, IN
Tel: 317-848-7153
FAX: 317-844-9314

AVX Midwest, MN
Tel: 952-974-9155
FAX: 952-974-9179

AVX Mid/Pacific, CA
Tel: 510-661-4100
FAX: 510-661-4101

AVX Southwest, AZ
Tel: 602-678-0384
FAX: 602-678-0385

AVX South Central, TX
Tel: 972-669-1223
FAX: 972-669-2090

AVX Southeast, GA
Tel: 404-608-8151
FAX: 770-972-0766

AVX Canada

Tel: 905-238-3151
FAX: 905-238-0319

AVX South America
Tel: ++55-11-2193-7200
FAX: ++55-11-2193-7210

EUROPE

**AVX Limited, England
European Headquarters**
Tel: ++44 (0) 1252-770000
FAX: ++44 (0) 1252-770001

AVX/ELCO, England
Tel: ++44 (0) 1638-675000
FAX: ++44 (0) 1638-675002

AVX S.A., France
Tel: ++33 (1) 69-18-46-00
FAX: ++33 (1) 69-28-73-87

AVX GmbH, Germany
Tel: ++49 (0) 8131-9004-0
FAX: ++49 (0) 8131-9004-44

AVX srl, Italy

Tel: ++390 (0)2 614-571
FAX: ++390 (0)2 614-2576

AVX Czech Republic
Tel: ++420 465-358-111
FAX: ++420 465-323-010

ASIA-PACIFIC

**AVX/Kyocera, Singapore
Asia-Pacific Headquarters**
Tel: (65) 6286-7555
FAX: (65) 6488-9880

AVX/Kyocera, Hong Kong
Tel: (852) 2-363-3303
FAX: (852) 2-765-8185

AVX/Kyocera, Korea
Tel: (82) 2-785-6504
FAX: (82) 2-784-5411

AVX/Kyocera, Taiwan
Tel: (886) 2-2698-8778
FAX: (886) 2-2698-8777

AVX/Kyocera, Malaysia
Tel: (60) 4-228-1190
FAX: (60) 4-228-1196

Elco, Japan

Tel: 045-943-2906/7
FAX: 045-943-2910

Kyocera, Japan - AVX

Tel: (81) 75-604-3426
FAX: (81) 75-604-3425

Kyocera, Japan - KDP

Tel: (81) 75-604-3424
FAX: (81) 75-604-3425

**AVX/Kyocera, Shanghai,
China**

Tel: 86-21 6341 0300
FAX: 86-21 6341 0330

AVX/Kyocera, Beijing, China

Tel: 86-10 8458 3385
Fax: 86-10 8458 3382

ASIA-KED

KED, Hong Kong
Tel: (852) 2305 1080
FAX: (852) 2305 1405

KED, Shanghai
Tel: (86) 21 6859 9898
FAX: (86) 21 5887 2542

KED, Beijing
Tel: (86) 10 5869 4655
FAX: (86) 10 5869 4677

KED, South Korea
Tel: (82) 2 783 3288
FAX: (82) 2 783 3207

KED, Taiwan
Tel: (886) 2 2950 0268
FAX: (886) 2 2950 0520

KED, Singapore
Tel: (65) 6255 3122
FAX: (65) 6255 5092

Contact:



SUNSTAR商斯达实业集团是集研发、生产、工程、销售、代理经销、技术咨询、信息服务等为一体的高科技企业，是专业高科技电子产品生产厂家，是具有 10 多年历史的专业电子元器件供应商，是中国最早和最大的仓储式连锁规模经营大型综合电子零部件代理分销商之一，是一家专业代理和分销世界各大品牌 IC 芯片和电子元器件的连锁经营综合性国际公司。在香港、北京、深圳、上海、西安、成都等全国主要电子市场设有直属分公司和产品展示展销窗口门市部专卖店及代理分销商，已在全国范围内建成强大统一的供货和代理分销网络。我们专业代理经销、开发生产电子元器件、集成电路、传感器、微波光电元器件、工控机/DOC/DOM 电子盘、专用电路、单片机开发、MCU/DSP/ARM/FPGA 软件硬件、二极管、三极管、模块等，是您可靠的一站式现货配套供应商、方案提供商、部件功能模块开发配套商。专业以现代信息产业（计算机、通讯及传感器）三大支柱之一的传感器为主营业务，专业经营各类传感器的代理、销售生产、网络信息、科技图书资料及配套产品设计、工程开发。我们的专业网站——中国传感器科技信息网（全球传感器数据库）www.SENSOR-IC.COM 服务于全球高科技生产商及贸易商，为企业科技产品开发提供技术交流平台。欢迎各厂商互通有无、交换信息、交换链接、发布寻求代理信息。欢迎国外高科技传感器、变送器、执行器、自动控制产品厂商介绍产品到中国，共同开拓市场。本网站是关于各种传感器-变送器-仪器仪表及工业自动化大型专业网站，深入到工业控制、系统工程计 测量、自动化、安防报警、消费电子等众多领域，把最新的传感器-变送器-仪器仪表买卖信息，最新技术供求，最新采购商，行业动态，发展方向，最新的技术应用和市场资讯及时的传递给广大科技开发、科学研究、产品设计人员。本网站已成功为石油、化工、电力、医药、生物、航空、航天、国防、能源、冶金、电子、工业、农业、交通、汽车、矿山、煤炭、纺织、信息、通信、IT、安防、环保、印刷、科研、气象、仪器仪表等领域从事科学研究、产品设计、开发、生产制造的科技人员、管理人员、和采购人员提供满意服务。我们公司专业生产、代理、经销、销售各种传感器、变送器、敏感元器件、开关、执行器、仪器仪表、自动化控制系统：专业从事设计、生产、销售各种传感器、变送器、各种测控仪表、热工仪表、现场控制器、计算机控制系统、数据采集系统、各类环境监控系统、专用控制系统应用软件以及嵌入式系统开发及应用等工作。如热敏电阻、压敏电阻、温度传感器、温度变送器、湿度传感器、湿度变送器、气体传感器、气体变送器、压力传感器、压力变送、称重传感器、物（液）位传感器、物（液）位变送器、流量传感器、流量变送器、电流（压）传感器、溶氧传感器、霍尔传感器、图像传感器、超声波传感器、位移传感器、速度传感器、加速度传感器、扭距传感器、红外传感器、紫外传感器、火焰传感器、激光传感器、振动传感器、轴角传感器、光电传感器、接近传感器、干簧管传感器、继电器传感器、微型电泵、磁敏（阻）传感器、压力开关、接近开关、光电开关、色标传感器、光纤传感器、齿轮测速传感器、时间继电器、计数器、计米器、温控仪、固态继电器、调压模块、电磁铁、电压表、电流表等特殊传感器。同时承接传感器应用电路、产品设计和自动化工程项目。

更多产品请看本公司产品专用销售网站：

商斯达中国传感器科技信息网：<http://www.sensor-ic.com/>

商斯达工控安防网：<http://www.pc-ps.net/>

商斯达电子元器件网：<http://www.sunstare.com/>

商斯达微波光电产品网：[HTTP://www.rfoe.net/](http://www.rfoe.net/)

商斯达消费电子产品网：<http://www.icasic.com/>

商斯达军工产品网：<http://www.junpinic.com/>

商斯达实业科技产品网：<http://www.sunstars.cn/> 传感器销售热线：

地址：深圳市福田区福华路福庆街鸿图大厦 1602 室

电话：0755-83607652 83376489 83376549 83370250 83370251 82500323

传真：0755-83376182 (0) 13902971329 MSN: SUNS888@hotmail.com

邮编：518033 E-mail: szss20@163.com QQ: 195847376

深圳赛格展销部：深圳华强北路赛格电子市场 2583 号 电话：0755-83665529 25059422

技术支持：0755-83394033 13501568376

欢迎索取免费详细资料、设计指南和光盘；产品凡多，未能尽录，欢迎来电查询。

北京分公司：北京海淀区知春路 132 号中发电子大厦 3097 号

TEL: 010-81159046 82615020 13501189838 FAX: 010-62543996

上海分公司：上海市北京东路 668 号上海赛格电子市场 D125 号

TEL: 021-28311762 56703037 13701955389 FAX: 021-56703037

西安分公司：西安高新开发区 20 所(中国电子科技集团导航技术研究所)

西安劳动南路 88 号电子商城二楼 D23 号

TEL: 029-81022619 13072977981 FAX: 029-88789382

SUNSTAR商斯达实业集团是集研发、生产、工程、销售、代理经销、技术咨询、信息服务等为一体的高科技企业，是专业高科技电子产品生产厂家，是具有10多年历史的专业电子元器件供应商，是中国最早和最大的仓储式连锁规模经营大型综合电子零部件代理分销商之一，是一家专业代理和分销世界各大品牌IC芯片和电子元器件的连锁经营综合性国际公司。在香港、北京、深圳、上海、西安、成都等全国主要电子市场设有直属分公司和产品展示展销窗口门市部专卖店及代理分销商，已在全国范围内建成强大统一的供货和代理分销网络。我们专业代理经销、开发生产电子元器件、集成电路、传感器、微波光电元器件、工控机/DOC/DOM电子盘、专用电路、单片机开发、MCU/DSP/ARM/FPGA软件硬件、二极管、三极管、模块等，是您可靠的一站式现货配套供应商、方案提供商、部件功能模块开发配套商。专业以现代信息产业（计算机、通讯及传感器）三大支柱之一的传感器为主营业务，专业经营各类传感器的代理、销售生产、网络信息、科技图书资料及配套产品设计、工程开发。我们的专业网站——中国传感器科技信息网（全球传感器数据库）www.SENSOR-IC.COM 服务于全球高科技生产商及贸易商，为企业科技产品开发提供技术交流平台。欢迎各厂商互通有无、交换信息、交换链接、发布寻求代理信息。欢迎国外高科技传感器、变送器、执行器、自动控制产品厂商介绍产品到中国，共同开拓市场。本网站是关于各种传感器-变送器-仪器仪表及工业自动化大型专业网站，深入到工业控制、系统工程计 测量、自动化、安防报警、消费电子等众多领域，把最新的传感器-变送器-仪器仪表买卖信息，最新技术供求，最新采购商，行业动态，发展方向，最新的技术应用和市场资讯及时的传递给广大科技开发、科学研究、产品设计人员。本网站已成功为石油、化工、电力、医药、生物、航空、航天、国防、能源、冶金、电子、工业、农业、交通、汽车、矿山、煤炭、纺织、信息、通信、IT、安防、环保、印刷、科研、气象、仪器仪表等领域从事科学研究、产品设计、开发、生产制造的科技人员、管理人员、和采购人员提供满意服务。我们公司专业生产、代理、经销、销售各种传感器、变送器、敏感元器件、开关、执行器、仪器仪表、自动化控制系统：专业从事设计、生产、销售各种传感器、变送器、各种测控仪表、热工仪表、现场控制器、计算机控制系统、数据采集系统、各类环境监控系统、专用控制系统应用软件以及嵌入式系统开发及应用等工作。如热敏电阻、压敏电阻、温度传感器、温度变送器、湿度传感器、湿度变送器、气体传感器、气体变送器、压力传感器、压力变送、称重传感器、物（液）位传感器、物（液）位变送器、流量传感器、流量变送器、电流（压）传感器、溶氧传感器、霍尔传感器、图像传感器、超声波传感器、位移传感器、速度传感器、加速度传感器、扭距传感器、红外传感器、紫外传感器、火焰传感器、激光传感器、振动传感器、轴角传感器、光电传感器、接近传感器、干簧管传感器、继电器传感器、微型电泵、磁敏（阻）传感器、压力开关、接近开关、光电开关、色标传感器、光纤传感器、齿轮测速传感器、时间继电器、计数器、计米器、温控仪、固态继电器、调压模块、电磁铁、电压表、电流表等特殊传感器。同时承接传感器应用电路、产品设计和自动化工程项目。

更多产品请看本公司产品专用销售网站：

商斯达中国传感器科技信息网：<http://www.sensor-ic.com/>

商斯达工控安防网：<http://www.pc-ps.net/>

商斯达电子元器件网：<http://www.sunstare.com/>

商斯达微波光电产品网：[HTTP://www.rfoe.net/](http://www.rfoe.net/)

商斯达消费电子产品网：<http://www.icasic.com/>

商斯达军工产品网：<http://www.junpinic.com/>

商斯达实业科技产品网：<http://www.sunstars.cn/>传感器销售热线：

地址：深圳市福田区福华路福庆街鸿图大厦1602室

电话：0755-83607652 83376489 83376549 83370250 83370251 82500323

传真：0755-83376182 (0) 13902971329 MSN: SUNS888@hotmail.com

邮编：518033 E-mail: szss20@163.com QQ: 195847376

深圳赛格展销部：深圳华强北路赛格电子市场2583号 电话：0755-83665529 25059422

技术支持：0755-83394033 13501568376

欢迎索取免费详细资料、设计指南和光盘；产品凡多，未能尽录，欢迎来电查询。

北京分公司：北京海淀区知春路132号中发电子大厦3097号

TEL: 010-81159046 82615020 13501189838 FAX: 010-62543996

上海分公司：上海市北京东路668号上海赛格电子市场D125号

TEL: 021-28311762 56703037 13701955389 FAX: 021-56703037

西安分公司：西安高新开发区20所(中国电子科技集团导航技术研究所)

西安劳动南路88号电子商城二楼D23号

TEL: 029-81022619 13072977981 FAX:029-88789382