



MMIC VCO w/ HALF FREQUENCY OUTPUT 9.05 - 10.15 GHz

Typical Applications

Low noise MMIC VCO w/Half Frequency, for:

- VSAT Radio
- Point to Point/Multi-Point Radio
- Test Equipment & Industrial Controls
- Military End-Use

Features

- Dual Output: $F_o = 9.05 - 10.15$ GHz
 $F_o/2 = 4.525 - 5.075$ GHz
- Pout: +13 dBm
- Phase Noise: -115 dBc/Hz @100 kHz Typ.
- No External Resonator Needed
- 32 Lead Ceramic 5x5mm SMT Package: 25mm²

Functional Diagram

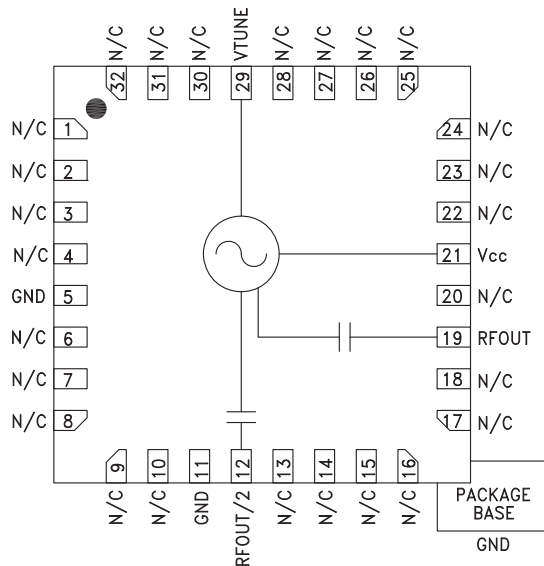

General Description

The HMC511LP5 & HMC511LP5E are GaAs InGaP Heterojunction Bipolar Transistor (HBT) MMIC VCOs. The HMC511LP5 & HMC511LP5E integrate resonators, negative resistance devices, varactor diodes and feature a half frequency output. The VCO's phase noise performance is excellent over temperature, shock, and process due to the oscillator's monolithic structure. Power output is +13 dBm typical from a +5V supply. The voltage controlled oscillator is packaged in a leadless QFN 5x5 mm surface mount package, and requires no external matching components.

Electrical Specifications, $T_A = +25^\circ C$, $V_{cc} = +5V$

Parameter	Min.	Typ.	Max.	Units
Frequency Range	F_o	9.05 - 10.15		GHz
	$F_o/2$	4.525 - 5.075		GHz
Power Output	RFOUT	+9	+16	dBm
	RFOUT/2	+5	+11	dBm
SSB Phase Noise @ 100 kHz Offset, $V_{tune} = +5V$ @ RFOUT		-115		dBc/Hz
Tune Voltage	V_{tune}	2	13	V
Supply Current (I_{cc}) ($V_{cc} = +5.0V$)		200	265	mA
Tune Port Leakage Current ($V_{tune} = 13V$)			10	μA
Output Return Loss		2		dB
Harmonics/Subharmonics	1/2	38		dBc
	2nd	15		dBc
	3rd	30		dBc
Pulling (into a 2.0:1 VSWR)		8		MHz pp
Pushing @ $V_{tune} = 5V$		15		MHz/V
Frequency Drift Rate		0.9		MHz/ $^\circ C$

For price, delivery, and to place orders, please contact Hittite Microwave Corporation:

SUNSTAR 微波光电 <http://www.hittite.com> / TEL:0755-83396822 FAX:0755-83376182 E-MAIL: szss20@163.com

Order On-line at www.hittite.com



HMC511LP5 / 511LP5E

MMIC VCO w/ HALF FREQUENCY OUTPUT 9.05 - 10.15 GHz

Frequency vs. Tuning Voltage, T= 25°C

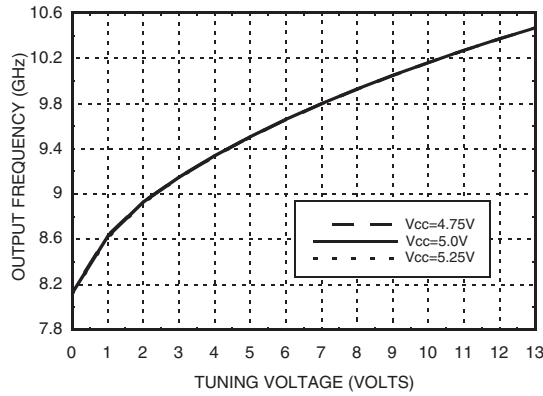

Frequency vs. Tuning Voltage, Vcc= +5V

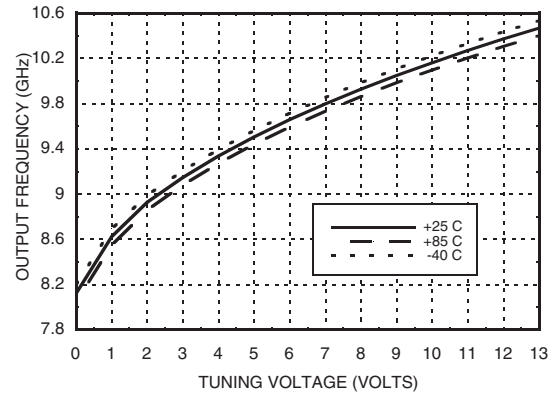

Sensitivity vs. Tuning Voltage, Vcc= +5V

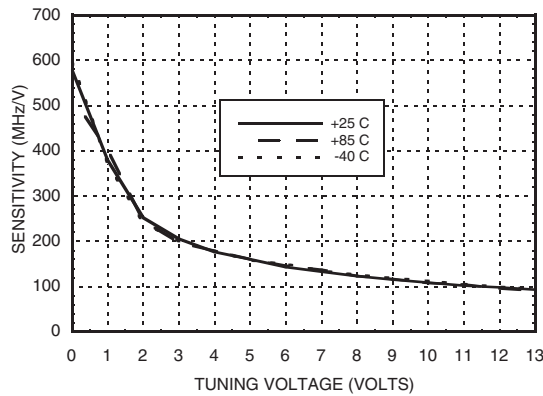

Output Power vs. Tuning Voltage, Vcc= +5V

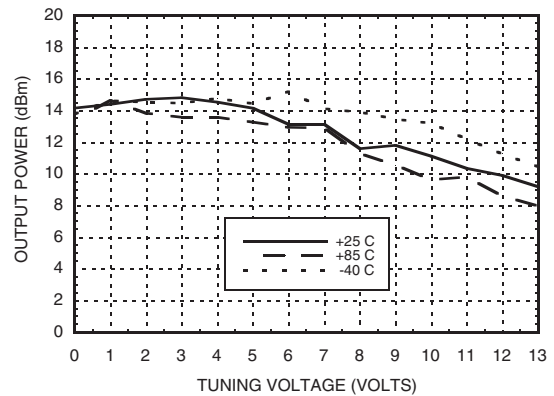

SSB Phase Noise vs. Tuning Voltage

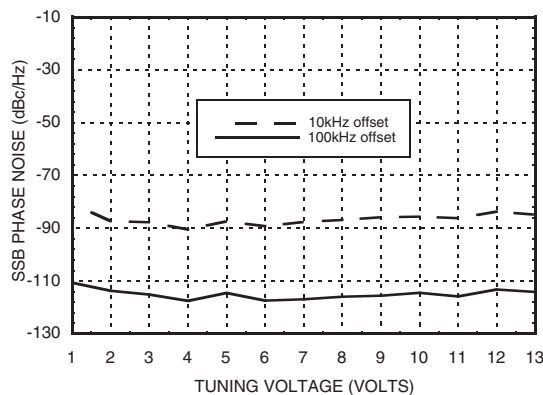

SSB Phase Noise @ Vtune = +5V

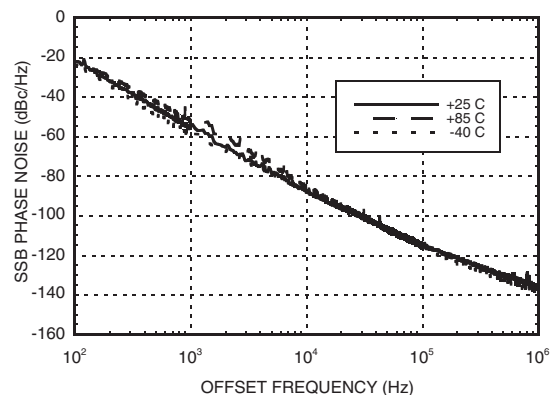



HMC511LP5 / 511LP5E

MMIC VCO w/ HALF FREQUENCY OUTPUT 9.05 - 10.15 GHz

**RFOUT/2 Frequency
vs. Tuning Voltage, Vcc= +5V**

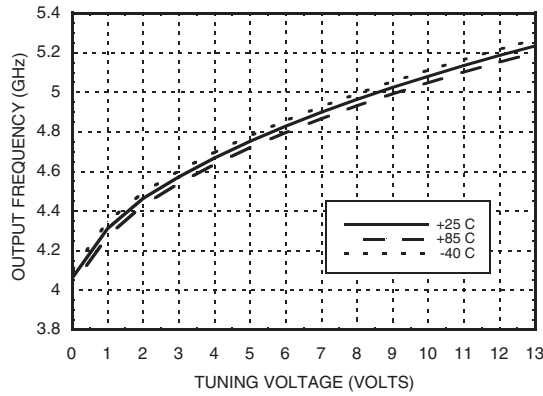

**RFOUT/2 Output Power
vs. Tuning Voltage, Vcc= +5V**

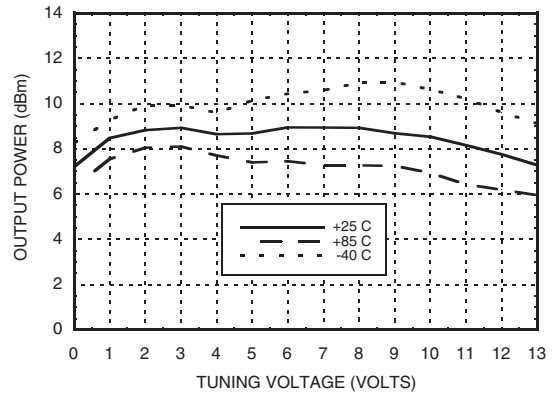

Absolute Maximum Ratings

Vcc	+5.5 Vdc
Vtune	0 to +15V
Junction Temperature	135 °C
Continuous Pdiss (T=85 °C) (derate 31.5 mW/C above 85 °C)	1.58 W
Thermal Resistance (junction to ground paddle)	31.6 °C/W
Storage Temperature	-65 to +150 °C
Operating Temperature	-40 to +85 °C
ESD Sensitivity (HBM)	Class 1A

Typical Supply Current vs. Vcc

Vcc (V)	Icc (mA)
4.75	245
5.0	265
5.25	285

Note: VCO will operate over full voltage range shown above.



**ELECTROSTATIC SENSITIVE DEVICE
OBSERVE HANDLING PRECAUTIONS**



MMIC VCO w/ HALF FREQUENCY OUTPUT 9.05 - 10.15 GHz

Outline Drawing

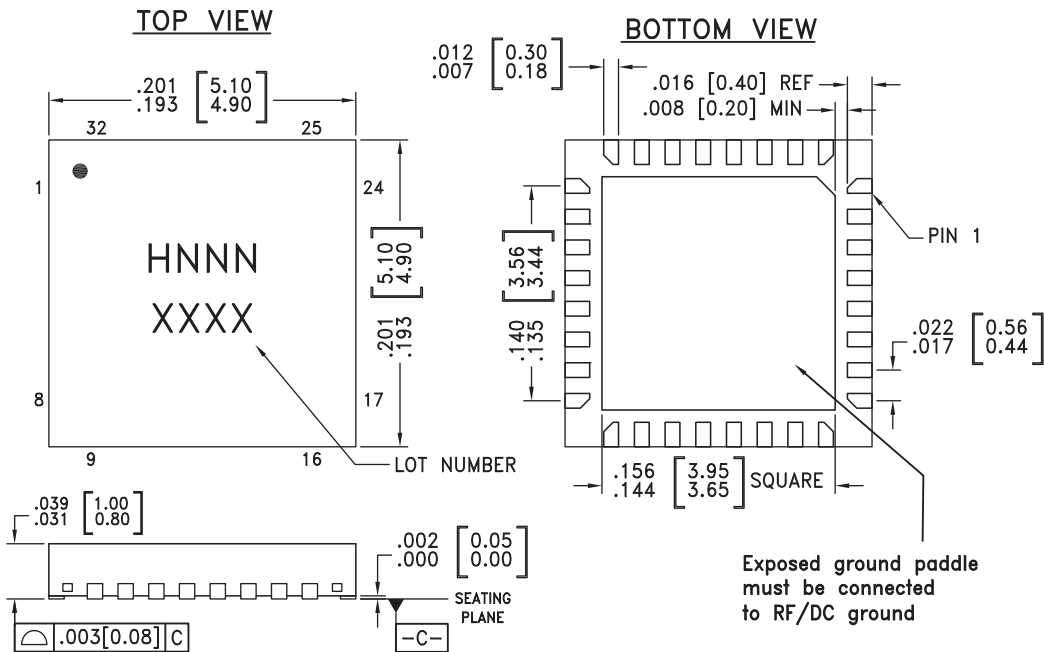

- NOTES:
1. LEADFRAME MATERIAL: COPPER ALLOY
 2. DIMENSIONS ARE IN INCHES [MILLIMETERS]
 3. LEAD SPACING TOLERANCE IS NON-CUMULATIVE.
 4. PAD BURR LENGTH SHALL BE 0.15mm MAXIMUM.
PAD BURR HEIGHT SHALL BE 0.05mm MAXIMUM.
 5. PACKAGE WARP SHALL NOT EXCEED 0.05mm.
 6. ALL GROUND LEADS AND GROUND PADDLE MUST BE SOLDERED TO PCB RF GROUND.
 7. REFER TO HITTITE APPLICATION NOTE FOR SUGGESTED LAND PATTERN.

Package Information

Part Number	Package Body Material	Lead Finish	MSL Rating	Package Marking ^[3]
HMC511LP5	Low Stress Injection Molded Plastic	Sn/Pb Solder	MSL3 ^[1]	H511 XXXX
HMC511LP5E	RoHS-compliant Low Stress Injection Molded Plastic	100% matte Sn	MSL3 ^[2]	H511 XXXX

[1] Max peak reflow temperature of 235 °C
 [2] Max peak reflow temperature of 260 °C
 [3] 4-Digit lot number XXXX



**MMIC VCO w/ HALF FREQUENCY
OUTPUT 9.05 - 10.15 GHz**

Pin Descriptions

Pin Number	Function	Description	Interface Schematic
1 - 4, 6 - 10, 13 - 18, 20, 22 - 28, 30 - 32	N/C	No Connection. These pins may be connected to RF/ DC ground. Performance will not be affected.	
12	RFOUT/2	Half frequency output (AC coupled).	
19	RFOUT	RF output (AC coupled).	
21	Vcc	Supply Voltage, +5V	
29	VTUNE	Control Voltage Input. Modulation port bandwidth dependent on drive source impedance.	
5, 11 Paddle	GND	Package bottom has an exposed metal paddle that must be connected to RF/DC ground.	

12

VCOS WITH Fo/2 OUTPUT - SMT

For price, delivery, and to place orders, please contact Hittite Microwave Corporation:

SUNSTAR 微波光电 <http://www.hittite.com> TEL:0755-83396822 FAX:0755-83376182 E-MAIL: szss20@163.com

Order On-line at www.hittite.com

Evaluation PCB

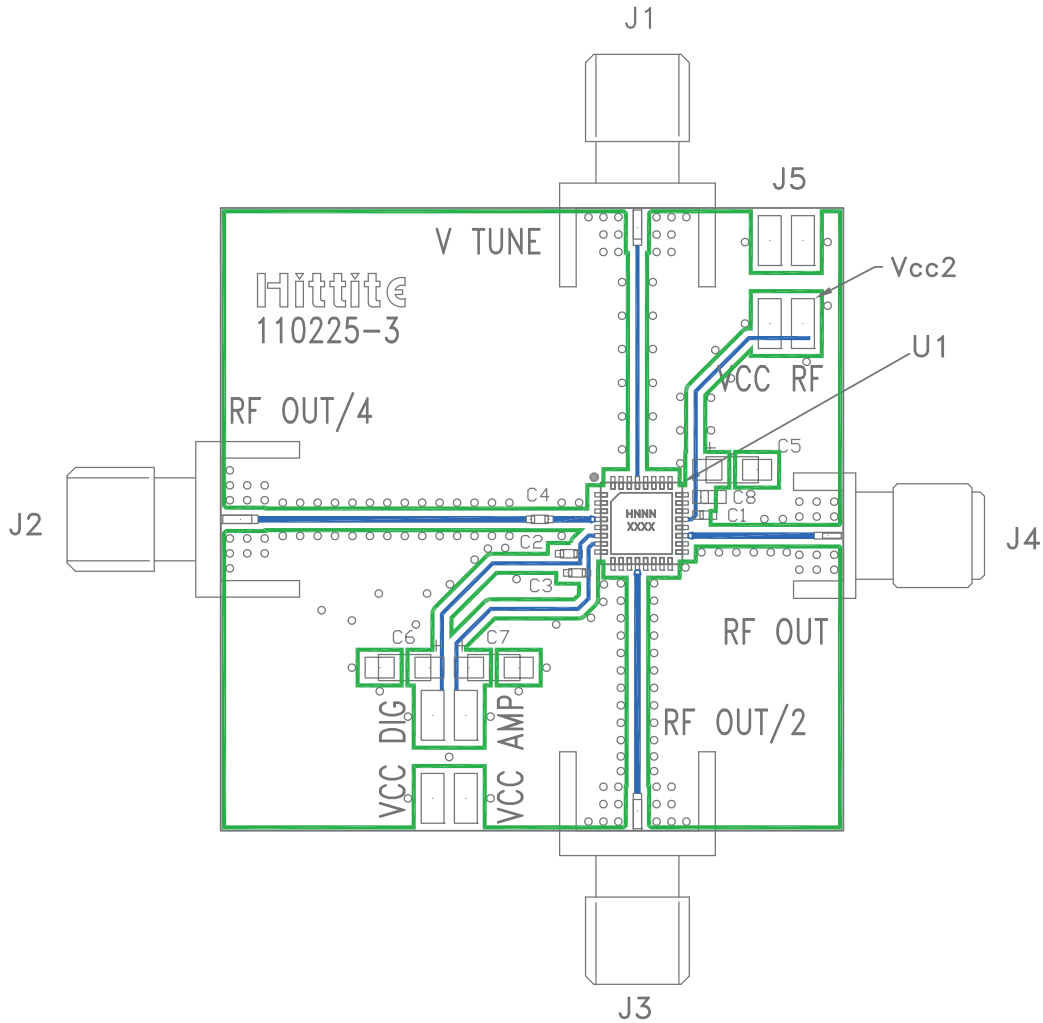

List of Materials for Evaluation PCB 110227 [1]

Item	Description
J1 - J4	PCB Mount SMA RF Connector
J5	2 mm DC Header
C1 - C3	100 pF Capacitor, 0402 Pkg.
C4	1,000 pF Capacitor, 0402 Pkg.
C5 - C7	2.2 μF Tantalum Capacitor
U1	HMC511LP5(E) VCO
PCB [2]	110225 Eval Board

[1] Reference this number when ordering complete evaluation PCB

[2] Circuit Board Material: Arlon 25FR

The circuit board used in the final application should use RF circuit design techniques. Signal lines should have 50 ohm impedance while the package ground leads and backside ground paddle should be connected directly to the ground plane similar to that shown. A sufficient number of via holes should be used to connect the top and bottom ground planes. The evaluation circuit board shown is available from Hittite upon request.