



GaAs MMIC SMT DOUBLE-BALANCED MIXER, 0.7 - 2.0 GHz

Typical Applications

The HMC207S8 / HMC207S8E is ideal for:

- Base Stations
- Cable Modems
- Portable Wireless

Features

- Conversion Loss: 9 dB
- LO / IF Isolation: 45 dB
- LO / RF Isolation: 40 dB
- Input IP3: +17 dBm

Functional Diagram

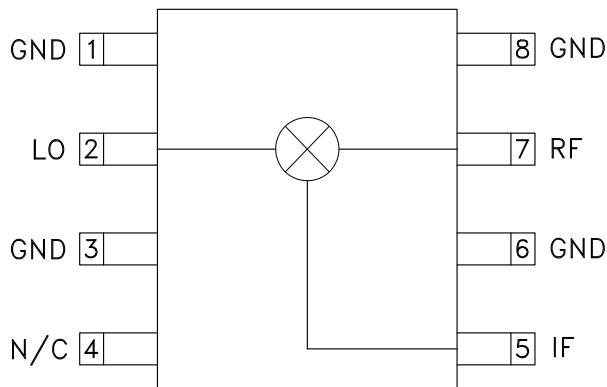

General Description

The HMC207S8 & HMC207S8E are miniature double-balanced mixers in 8 lead plastic surface mount Small Outline IC (SOIC) packages. This passive MMIC mixer is constructed of GaAs Schottky diodes and novel planar transformer baluns on the chip. The device can be used as an upconverter, downconverter, biphas modulator (de)modulator, or phase comparator. The consistent MMIC performance will improve system operation and assure regulatory compliance. The high LO suppression of 45 to 50 dB yields excellent carrier suppression for modulator applications.

Electrical Specifications, $T_A = +25^\circ C$, As a Function of LO Drive

Parameter	LO = +13 dBm IF = 70 MHz			LO = +10 dBm IF = 70 MHz			Units
	Min.	Typ.	Max.	Min.	Typ.	Max.	
Frequency Range, RF & LO	0.7 - 2.0			0.8 - 1.2			GHz
Frequency Range, IF	DC - 0.3			DC - 0.3			GHz
Conversion Loss		9	10.5		7.5	10	dB
Noise Figure (SSB)		9	10.5		7.5	10	dB
LO to RF Isolation	32	40		40	45		dB
LO to IF Isolation	38	45		40	45		dB
RF to IF Isolation	17	23		18	22		dB
IP3 (Input)	14	17		12	15		dBm
1 dB Gain Compression (Input)	8	11		7	10		dBm

For price, delivery, and to place orders, please contact Hittite Microwave Corporation:

SUNSTAR 微波光电 <http://www.hittite.com> / TEL:0755-83396822 FAX:0755-83376182 E-MAIL: szss20@163.com

Order On-line at www.hittite.com



HMC207S8 / 207S8E

GaAs MMIC SMT DOUBLE-BALANCED MIXER, 0.7 - 2.0 GHz

Conversion Loss vs Temperature @ LO = +13 dBm

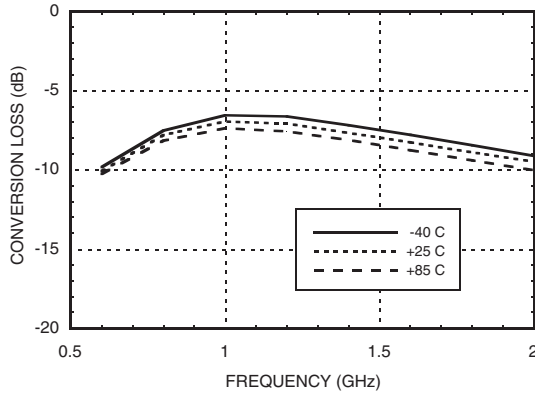

Isolation @ LO = +13 dBm

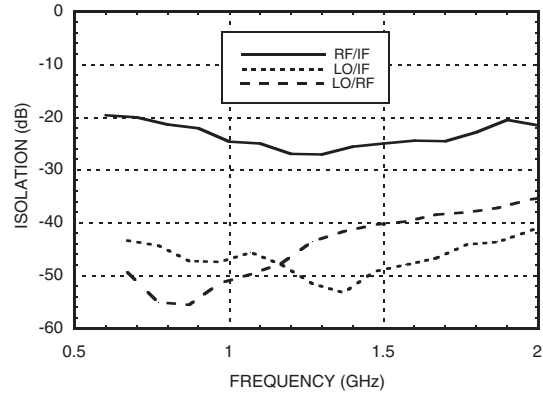

Conversion Loss vs. LO Drive

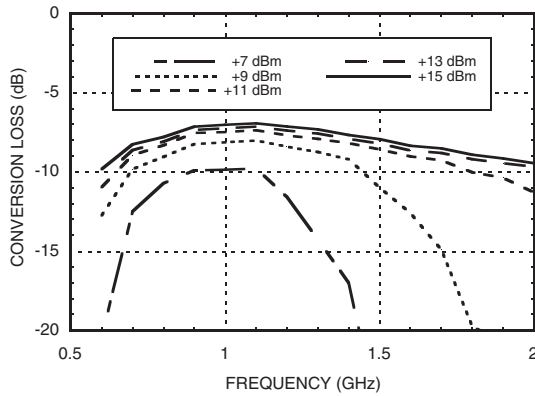

Return Loss @ LO = +13 dBm

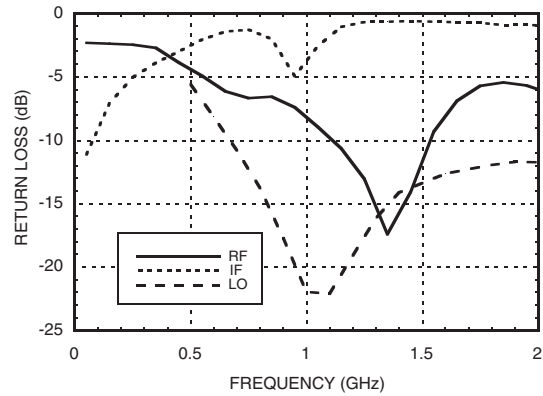

IF Bandwidth @ LO = +13 dBm

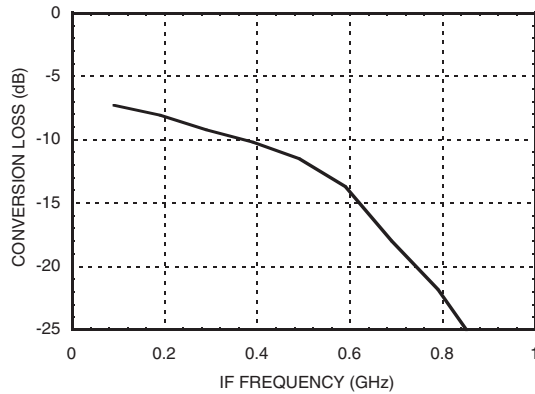

P1dB vs. Temperature @ LO = +13 dBm

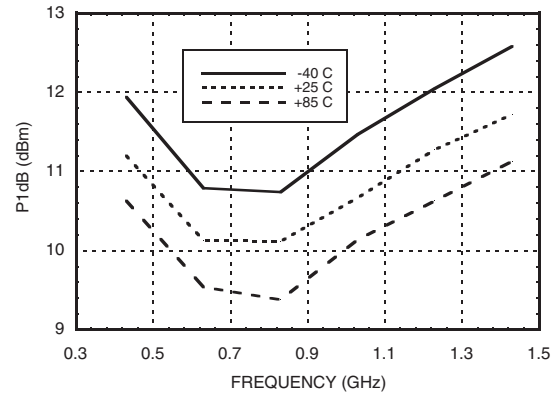

GaAs MMIC SMT DOUBLE-BALANCED MIXER, 0.7 - 2.0 GHz



Input IP3 vs. LO Drive

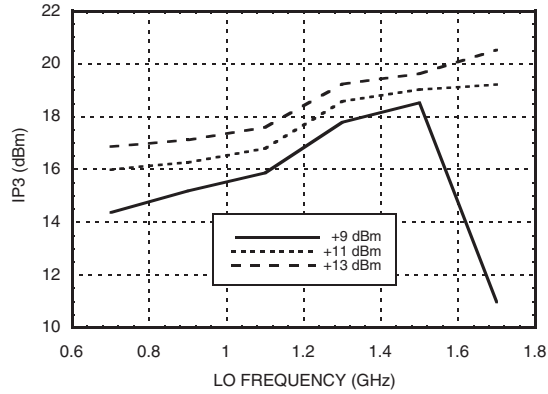

Input IP3 vs. Temperature @ LO = +13 dBm

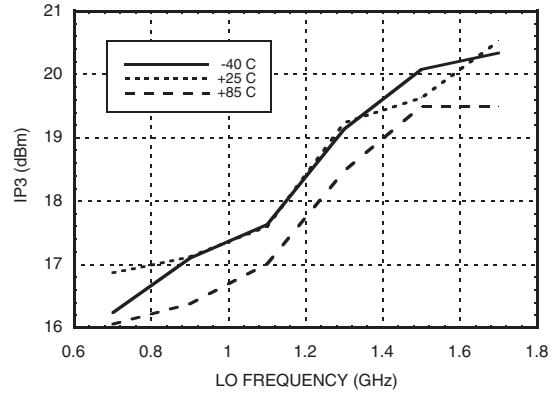

Input IP2 vs. LO Drive

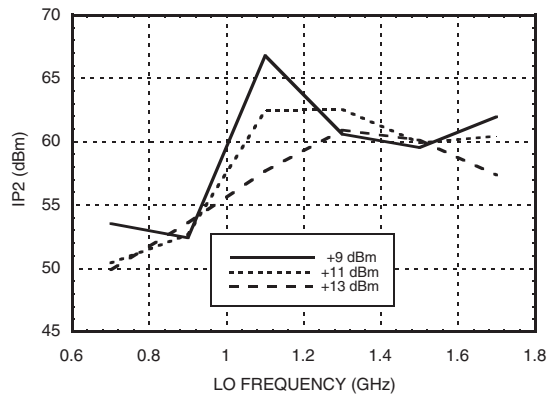

Input IP2 vs. Temperature @ LO = +13 dBm

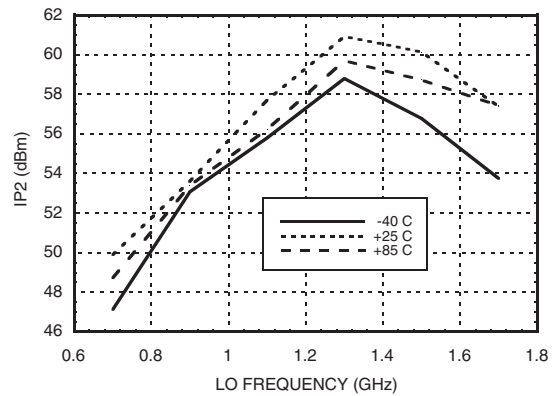



HMC207S8 / 207S8E

GaAs MMIC SMT DOUBLE-BALANCED MIXER, 0.7 - 2.0 GHz

MxN Spurious Outputs

mRF	nLO				
	0	1	2	3	4
0	xx	19	27	20	36
1	17	0	43	43	39
2	64	66	63	74	75
3	91	94	92	65	86
4	>105	>105	>105	97	97

RF = 0.9 GHz @ -10 dBm
 LO = 0.97 GHz @ +13 dBm
 All values in dBc relative to the IF

Harmonics of LO

LO Freq. (GHz)	nLO Spur at RF Port			
	1	2	3	4
0.7	49	38	54	50
0.9	54	35	53	59
1.1	49	34	53	57
1.3	42	34	46	56
1.5	40	36	43	58
1.7	38	42	40	61

LO = +13 dBm
 Values in dBc below input LO level measured at RF Port.

Absolute Maximum Ratings

RF / IF Input	+13 dBm
LO Drive	+27 dBm
Storage Temperature	-65 to +150 °C
Operating Temperature	-40 to +85 °C
ESD Sensitivity (HBM)	Class 1A



ELECTROSTATIC SENSITIVE DEVICE
 OBSERVE HANDLING PRECAUTIONS



Outline Drawing

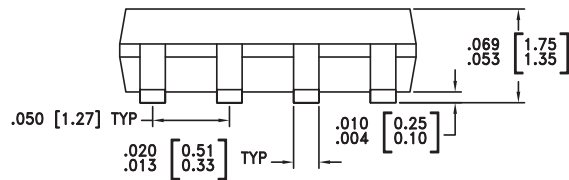
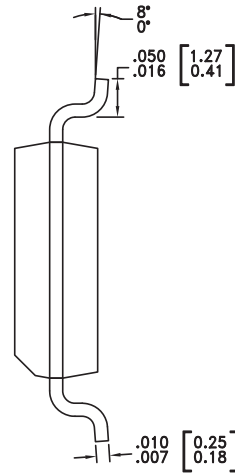
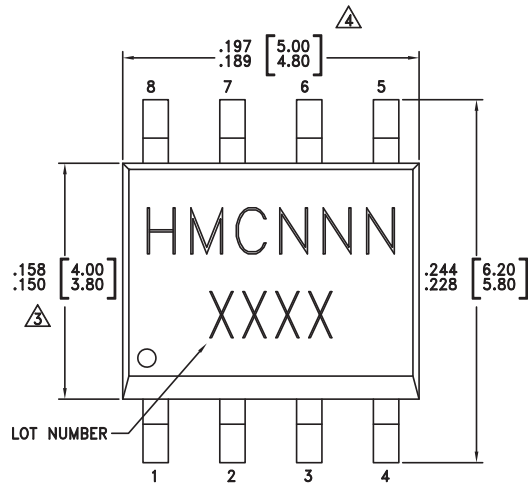

NOTES:

1. LEADFRAME MATERIAL: COPPER ALLOY
2. DIMENSIONS ARE IN INCHES [MILLIMETERS].
- ⚠ DIMENSION DOES NOT INCLUDE MOLDFLASH OF 0.15mm PER SIDE.
- ⚠ DIMENSION DOES NOT INCLUDE MOLDFLASH OF 0.25mm PER SIDE.
5. ALL GROUND LEADS MUST BE SOLDERED TO PCB RF GROUND.

Package Information

Part Number	Package Body Material	Lead Finish	MSL Rating	Package Marking ^[3]
HMC207S8	Low Stress Injection Molded Plastic	Sn/Pb Solder	MSL1 ^[1]	HMC207 XXXX
HMC207S8E	RoHS-compliant Low Stress Injection Molded Plastic	100% matte Sn	MSL1 ^[2]	HMC207 XXXX

[1] Max peak reflow temperature of 235 °C
 [2] Max peak reflow temperature of 260 °C
 [3] 4-Digit lot number XXXX

For price, delivery, and to place orders, please contact Hittite Microwave Corporation:

SUNSTAR 微波光电 <http://www.hittite.com> / TEL:0755-83396822 FAX:0755-83376182 E-MAIL: szss20@163.com
 Order On-line at www.hittite.com

Evaluation PCB

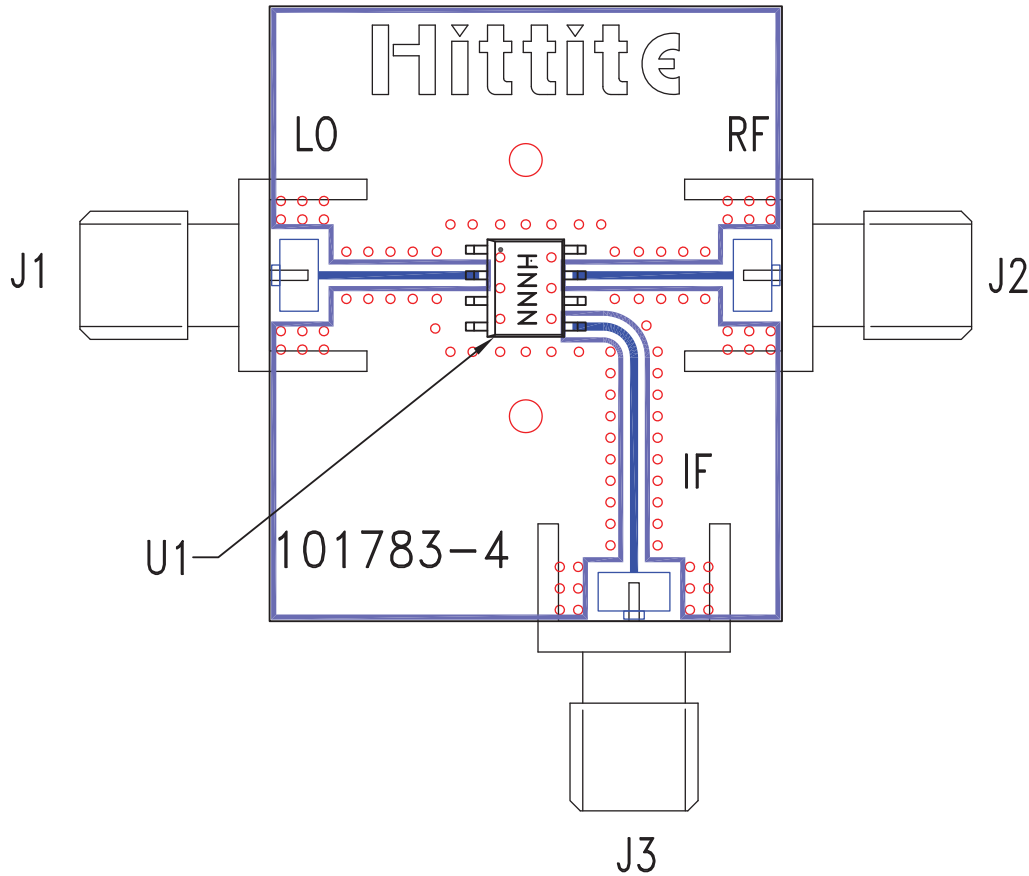

List of Materials for Evaluation PCB 101785 [1]

Item	Description
J1 - J3	PCB Mount SMA RF Connector
U1	HMC207S8 / HMC207S8E Mixer
PCB [2]	101783 Evaluation Board

[1] Reference this number when ordering complete evaluation PCB

[2] Circuit Board Material: Rogers 4350

The circuit board used in the final application should use RF circuit design techniques. Signal lines should have 50 ohm impedance while the package ground leads should be connected directly to the ground plane similar to that shown. A sufficient number of via holes should be used to connect the top and bottom ground planes. The evaluation circuit board shown is available from Hittite upon request.