



## 13 Gbps, 2:1 SELECTOR w/ PROGRAMMABLE OUTPUT VOLTAGE & POSITIVE SUPPLY

### Typical Applications

The HMC748LC3C is ideal for:

- 2:1 Multiplexer up to 13 Gbps
- RF ATE Applications
- Broadband Test & Measurement
- Serial Data Transmission up to 13 Gbps
- Redundant Path Switching
- Built-in Test

### Features

- Supports High Data Rates: up to 13 Gbps
- Single-ended inputs
- Differential & Single-ended outputs
- Fast Rise and Fall Times: 22 / 22 ps
- Low Power Consumption: 250 mW typ.
- Programmable Differential Output Voltage Swing: 600 - 1200 mV
- Propagation Delay: 125 ps
- Single Supply: +3.3V
- 16 Lead Ceramic 3x3mm SMT Package: 9mm<sup>2</sup>

### Functional Diagram

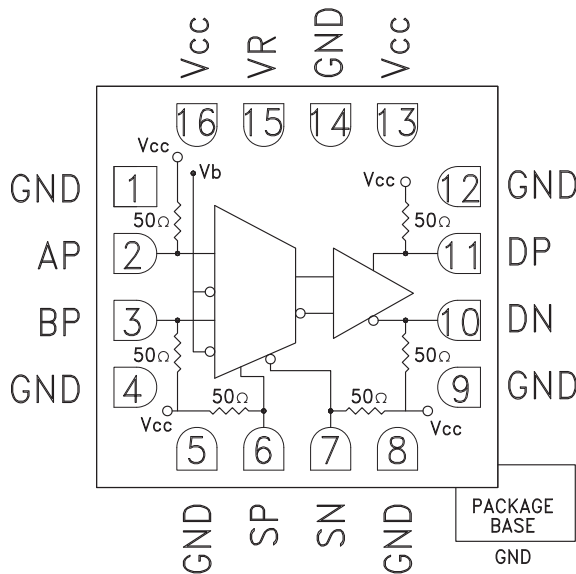

### General Description

The HMC748LC3C is a 2:1 Selector designed to support data transmission rates of up to 13 Gbps, and selector port operation of up to 13 GHz. The selector routes one of the two single-ended inputs to the differential output upon assertion of the proper select port. The HMC748LC3C also features an output level control pin, VR, which allows for loss compensation or for signal level optimization.

All single-ended input signals to the HMC748LC3C are terminated with 50 Ohms to Vcc on-chip, and may be either AC or DC coupled. The outputs of the HMC748LC3C may be operated either differentially or single-ended. Inputs or outputs can be connected directly to a 50 Ohm to Vcc terminated system, while DC blocking capacitors may be used if the terminating system is 50 Ohms to ground. The HMC748LC3C operates from a single +3.3V DC supply and is housed in a ceramic RoHS compliant 3x3 mm SMT package.

### Electrical Specifications, $T_A = +25^\circ\text{C}$ , $V_{cc} = +3.3\text{V}$

Parameter	Conditions	Min.	Typ.	Max	Units
Power Supply Voltage		3.0	3.3	3.6	V
Power Supply Current			76		mA
Maximum Data Rate			13		Gbps
Maximum Select Rate			13		GHz
Maximum Serial Transmission Rate			26		Gbps
Input High Voltage		2.8		3.8	V
Input Low Voltage		2.1		3.3	V
Input Return Loss	Frequency <13 GHz		10		dB
Output Amplitude	Single-Ended, peak-to-peak		550		mVpp
	Differential, peak-to-peak		1100		mVpp
Output High Voltage			3.25		V

For price, delivery, and to place orders, please contact Hittite Microwave Corporation:

SUNSTAR 微波光电 <http://www.hittite.com> / TEL:0755-83396822 FAX:0755-83376182 E-MAIL: szss20@163.com  
Order On-line at [www.hittite.com](http://www.hittite.com)



### 13 Gbps, 2:1 SELECTOR w/ PROGRAMMABLE OUTPUT VOLTAGE & POSITIVE SUPPLY

#### Electrical Specifications (continued)

Parameter	Conditions	Min.	Typ.	Max	Units
Output Low Voltage			2		V
Output Rise / Fall Time	Differential, 20% - 80%		22 / 22		ps
Output Return Loss	Frequency <13 GHz		10		dB
Random Jitter, Jr	rms <sup>[1]</sup>			0.2	ps rms
Deterministic Jitter, Jd	peak-to-peak, 2 <sup>15</sup> -1 PRBS input <sup>[2]</sup>		2		ps, pp
Propagation Delay, A or B to D <sub>OUT</sub> , t <sub>d</sub>			125		ps
Propagation Delay Select to Data, t <sub>ds</sub>			135		ps
Set Up & Hold Time, t <sub>SH</sub>			6		ps

[1] Upper limit of random jitter, Jr, determined by measuring and integrating output phase noise with a sinusoidal input at 5, 10, and 13.5 GHz over temperature

[2] Deterministic jitter calculated by simultaneously measuring the jitter of a 200 mV, 12.5 GHz, 2<sup>15</sup>-1 PRBS input, and a single-ended output

#### DC Current vs. Supply Voltage [1] [2]

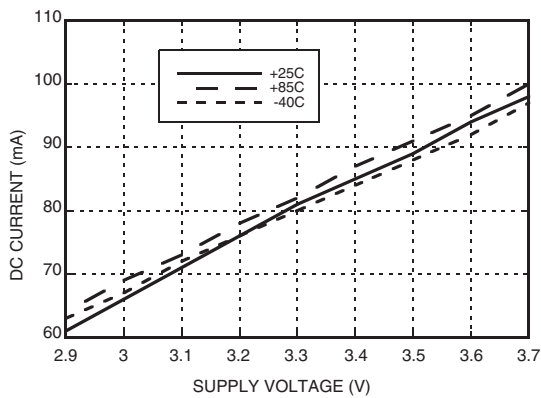

#### Output Differential vs. Supply Voltage [1] [2]

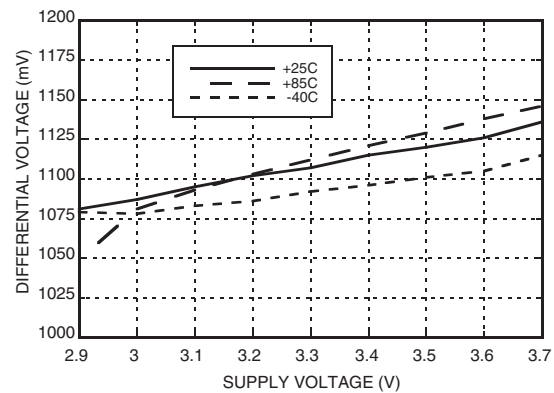

#### Rise / Fall Time vs. Supply Voltage [1] [2]

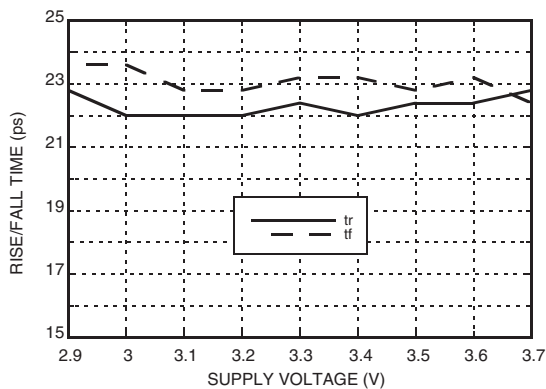

#### Output Differential vs. Frequency [1]

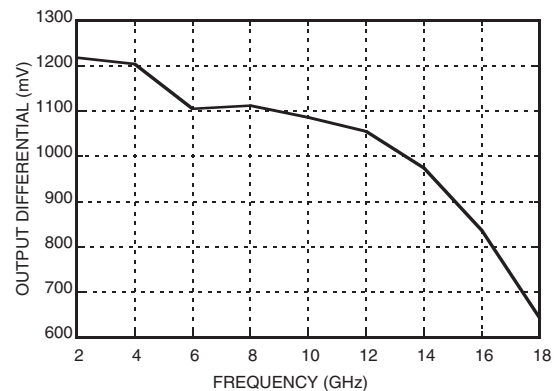

[1] VR = +3.3V

[2] Frequency = 13 GHz



v02.1209

**13 Gbps, 2:1 SELECTOR w/ PROGRAMMABLE OUTPUT VOLTAGE & POSITIVE SUPPLY**

7

HIGH SPEED LOGIC - SMT

**Output Differential vs. VR [2]**

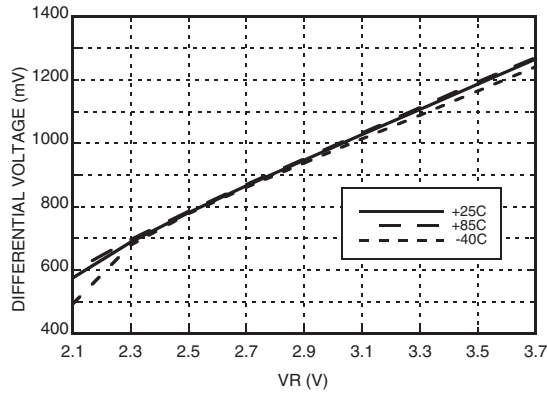

**Rise / Fall Time vs. VR [2]**

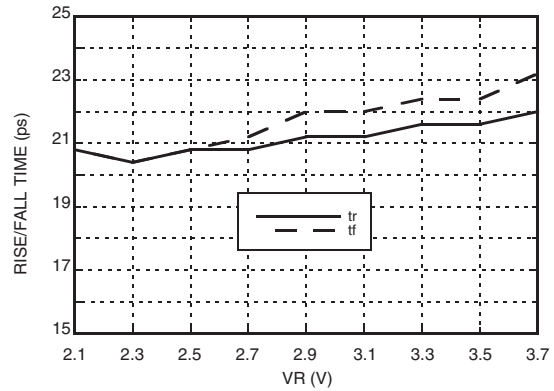

**Input Return Loss vs. Frequency**

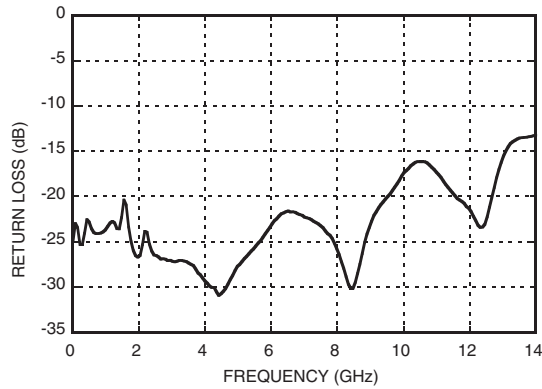

**Output Return Loss vs. Frequency**

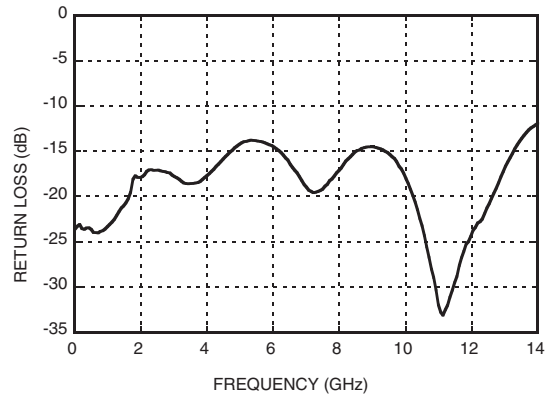

**Select Port Return Loss vs. Frequency**

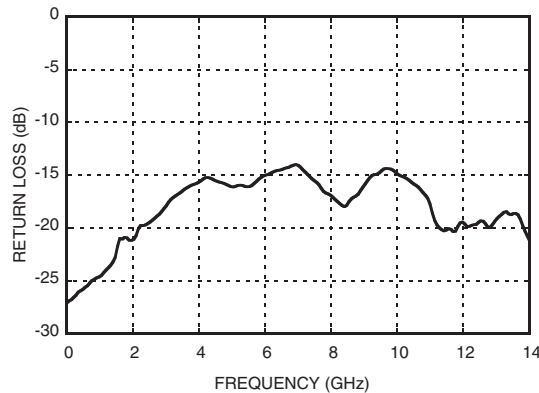

[1] VR = +3.3V

[2] Frequency = 13 GHz



v02.1209

**13 Gbps, 2:1 SELECTOR w/ PROGRAMMABLE OUTPUT VOLTAGE & POSITIVE SUPPLY**

**Eye Diagram**

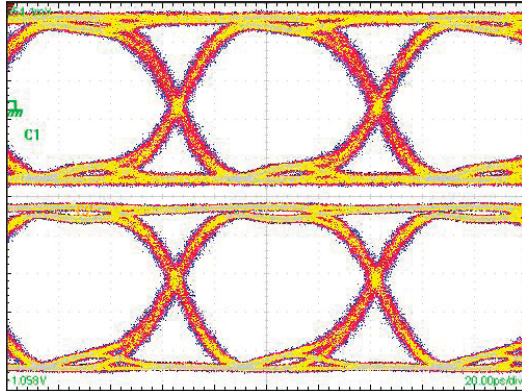

[1] Test Conditions:  
 Waveform generated with an Agilent N4903A J-Bert.  
 Rate = 13 GHz  
 Eye Diagram data presented on a Tektronix CSA 8000  
 Device is AC coupled to scope.

**Timing Diagram**

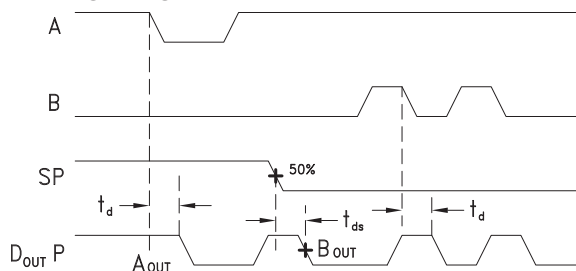

$t_d$  = propagation delay, A or B to Dout  
 $t_{ds}$  = propagation delay, Select to Dout

**Truth Table**

Inputs		Outputs
SP	SN	DP
L	H	A -> D
H	L	B -> D

H - Positive voltage level  
 L - Negative voltage level

Notes:  
 D = DP - DN  
 S = SP - SN



### 13 Gbps, 2:1 SELECTOR w/ PROGRAMMABLE OUTPUT VOLTAGE & POSITIVE SUPPLY

#### Absolute Maximum Ratings

Power Supply Voltage (Vcc)	-0.5V to +3.7V
Input Signals	Vcc - 2V to Vcc + 0.5V
Output Signals	+1V to +3.7V
Storage Temperature	-65°C to +150°C
Operating Temperature	-40°C to +85°C



ELECTROSTATIC SENSITIVE DEVICE  
OBSERVE HANDLING PRECAUTIONS

7

HIGH SPEED LOGIC - SMT

#### Outline Drawing

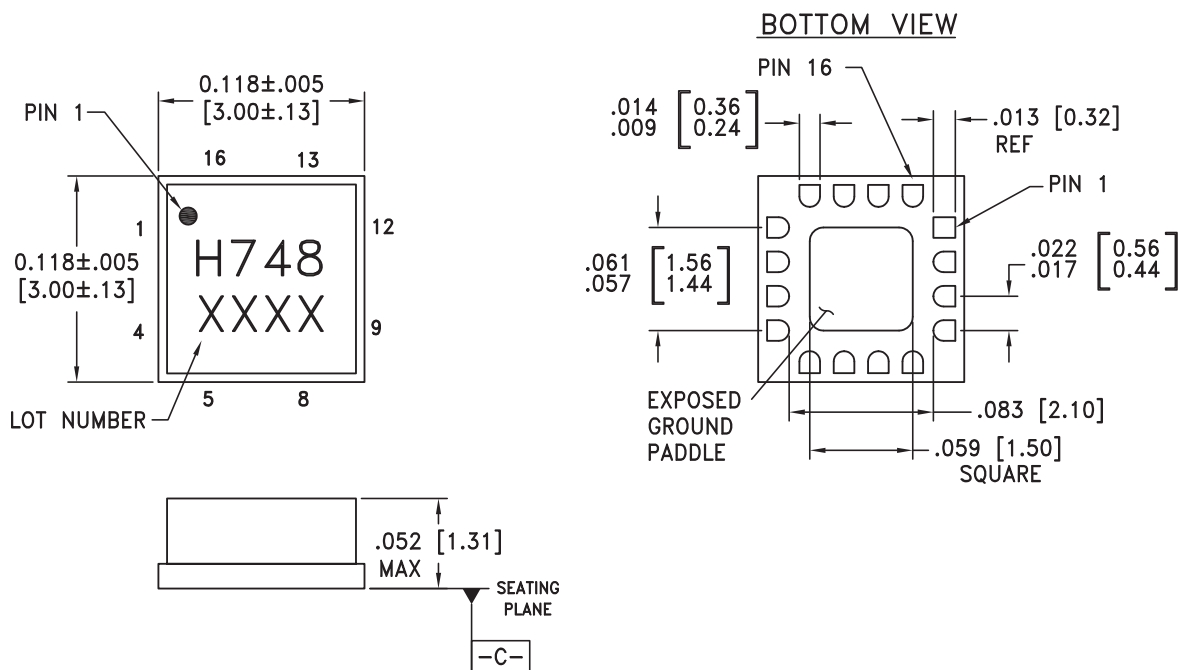

NOTES:

1. PACKAGE BODY MATERIAL: ALUMINA
2. LEAD AND GROUND PADDLE PLATING:  
30-80 MICROINCHES GOLD OVER 50 MICROINCHES MINIMUM NICKEL.
3. DIMENSIONS ARE IN INCHES [MILLIMETERS].
4. LEAD SPACING TOLERANCE IS NON-CUMULATIVE.
5. PACKAGE WARP SHALL NOT EXCEED 0.05mm DATUM -C-
6. ALL GROUND LEADS MUST BE SOLDERED TO PCB RF GROUND.
7. PADDLE MUST BE SOLDERED TO GND.



**13 Gbps, 2:1 SELECTOR w/ PROGRAMMABLE  
 OUTPUT VOLTAGE & POSITIVE SUPPLY**

**Pin Descriptions**

Pin Number	Function	Description	Interface Schematic
1, 4, 5, 8, 9, 12	GND	Signal Grounds	
2, 3	AP, BP	Data Inputs	
6, 7	SP, SN	Select Inputs	
10, 11	DN, DP	Data Outputs	
13, 16	Vcc	Positive Supply	
14, Package Base	GND	Supply Ground	
15	VR	Output level control. Output level may be adjusted by applying a voltage to VR per "Output Differential vs. VR" plot.	



**13 Gbps, 2:1 SELECTOR w/ PROGRAMMABLE OUTPUT VOLTAGE & POSITIVE SUPPLY**

**Evaluation PCB**

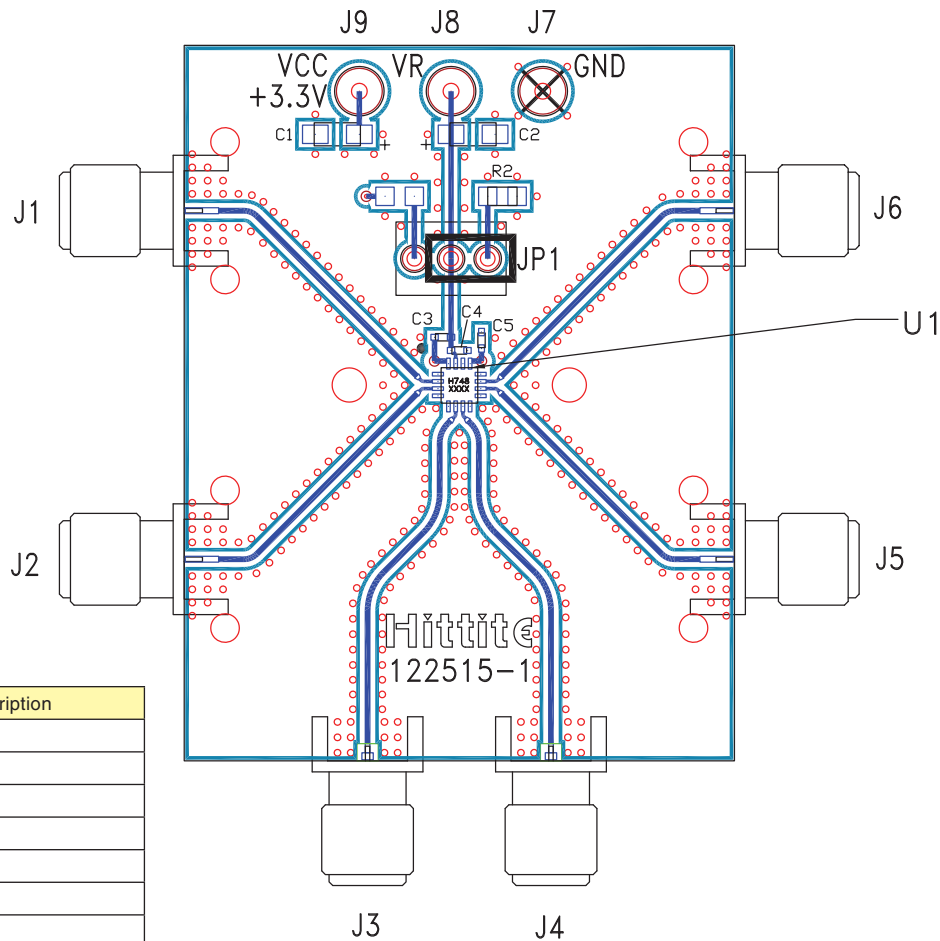

Item	Description
J1	AP
J2	BP
J3	SP
J4	SN
J5	DN
J6	DP
J7	GND
J8	VR
J9	Vcc

**List of Materials for Evaluation PCB 122517 [1]**

Item	Description
J1 - J6	PCB Mount SMA RF Connectors
J7 - J9	DC Pin
JP1	Shorting Jumper
C1, C2	4.7 $\mu$ F Capacitor, Tantalum
C3 - C5	100 pF Capacitor, 0402 Pkg.
R2	10 Ohm Resistor, 0603 Pkg.
U1	HMC748LC3C High Speed Logic, 2:1 Selector
PCB [2]	122515 Evaluation Board

[1] Reference this number when ordering complete evaluation PCB

[2] Circuit Board Material: Arlon 25FR

The circuit board used in the application should use RF circuit design techniques. Signal lines should have 50 Ohm impedance while the package ground leads should be connected directly to the ground plane similar to that shown. The exposed package base should be connected to GND. A sufficient number of via holes should be used to connect the top and bottom ground planes. The evaluation circuit board shown is available from Hittite upon request.



**13 Gbps, 2:1 SELECTOR w/ PROGRAMMABLE OUTPUT VOLTAGE & POSITIVE SUPPLY**

**Application Circuit**

