



v02.0805

HMC183QS24 / 183QS24E

GaAs MMIC SP8T NON-REFLECTIVE SWITCH, DC - 2 GHz



Typical Applications

The HMC183QS24 / HMC183QS24E is ideal for:

- Basestation Infrastructure

Features

Low Insertion Loss (1 GHz): 0.8dB

Integrated 3:8 Decoder

24 Lead QSOP Package

Functional Diagram

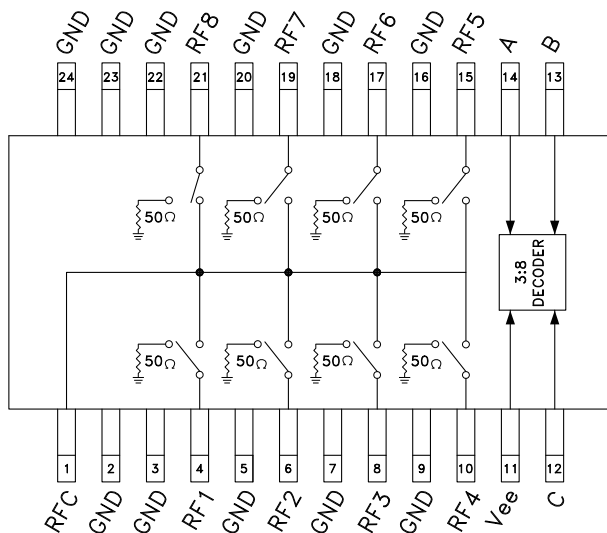

General Description

The HMC183QS24 & HMC183QS24E are low-cost non-reflective SP8T switches in 24-lead QSOP packages for use in antenna diversity, switched filter banks, gain/attenuation selection, and general channel multiplexing applications. A 3:8 decoder is integrated on the switch, requiring only 3 control lines with a negative bias to select an RF path. The 3:8 decoder replaces 16 control lines normally required by GaAs SP8T switches. Switch outputs are terminated when "off". The QSOP24 package occupies the same area as a 14-lead SOIC. See positive bias/TTL version HMC253QS24.

Electrical Specifications,

$T_A = +25^\circ C$, For 0/-5V Control and Vee = -5V in a 50 Ohm System

Parameter	Frequency	Min.	Typ.	Max.	Units
Insertion Loss	DC - 1.0 GHz		0.8	1.2	dB
	DC - 1.5 GHz		1.0	1.5	dB
	DC - 2.0 GHz		1.3	1.8	dB
Isolation	DC - 0.5 GHz	38	42		dB
	DC - 1.0 GHz	32	36		dB
	DC - 1.5 GHz	29	33		dB
	DC - 2.0 GHz	26	30		dB
Return Loss	DC - 1.0 GHz	16	20		dB
	DC - 1.5 GHz	10	14		dB
	DC - 2.0 GHz	7	11		dB
Return Loss	DC - 1.0 GHz	12	15		dB
	DC - 1.5 GHz	10	13		dB
	DC - 2.0 GHz	10	13		dB
Input Power for 1 dB Compression	50 MHz		18		dBm
	0.5 - 2.0 GHz		20		dBm
Input Third Order Intercept (Two-Tone Input Power = +7 dBm Each Tone)	50 MHz	30	35		dBm
	0.5 - 2.0 GHz	37	42		dBm
Switching Characteristics	DC - 2.0 GHz	tRISE, tFALL (10/90% RF)	35		ns
		tON, tOFF (50% CTL to 10/90% RF)	50		ns

For price, delivery, and to place orders, please contact Hittite Microwave Corporation:
20 Alpha Road, Chelmsford, MA 01824 Phone: 978-250-3343 Fax: 978-250-3373

Order On-line at www.hittite.com



v02.0805



HMC183QS24 / 183QS24E

GaAs MMIC SP8T NON-REFLECTIVE SWITCH, DC - 2 GHz

Insertion Loss

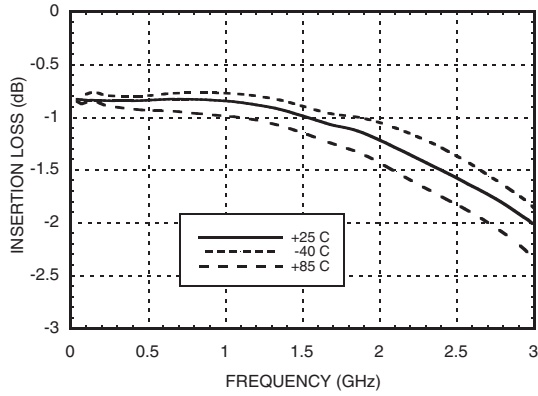

Isolation

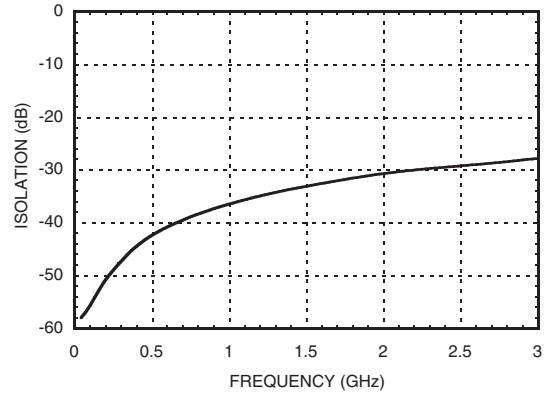

Return Loss

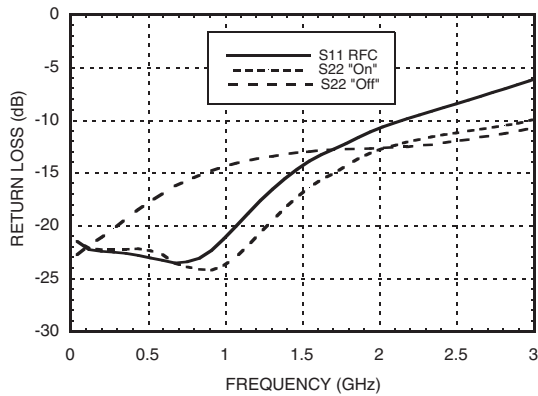

Isolation Between Several RF I/Os

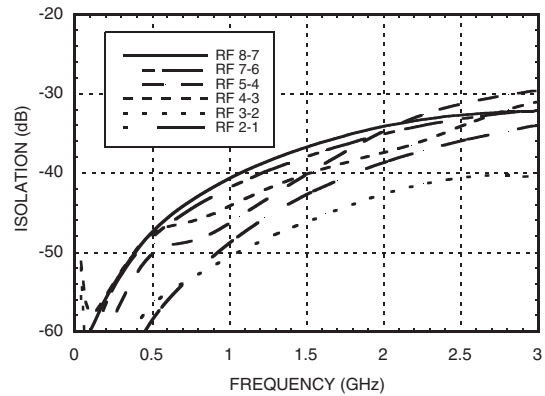

Bias Voltage & Current

Vee Range = -5.0 Vdc ± 10%		
Vee (Vdc)	Iee (Typ.) (mA)	Iee (Max.) (mA)
-5.0	6.0	9.0

Control Voltages

State	Bias Condition
Low	0 to -3 VDC 2.70 uA Typ.
High	-5 to -4.2 VDC @ 5 uA Typ.

For price, delivery, and to place orders, please contact Hittite Microwave Corporation:
20 Alpha Road, Chelmsford, MA 01824 Phone: 978-250-3343 Fax: 978-250-3373

Order On-line at www.hittite.com



v02.0805



HMC183QS24 / 183QS24E

GaAs MMIC SP8T NON-REFLECTIVE SWITCH, DC - 2 GHz

Absolute Maximum Ratings

Bias Voltage Range (Port Vee)	-7.0 Vdc
Control Voltage Range (A & B)	Vee -0.5 to +1.0 Vdc
Storage Temperature	-65 to +150 °C
Operating Temperature	-40 to +85 °C
Maximum Input Power	+26 dBm (<500 MHz) +29 dBm (>500 MHz)

Truth Table

Control Input			Signal Path State
A	B	C	RFCOM to:
High	High	High	RF1
Low	High	High	RF2
High	Low	High	RF3
Low	Low	High	RF4
High	High	Low	RF5
Low	High	Low	RF6
High	Low	Low	RF7
Low	Low	Low	RF8



ELECTROSTATIC SENSITIVE DEVICE
OBSERVE HANDLING PRECAUTIONS

10

SWITCHES - SMT

Outline Drawing

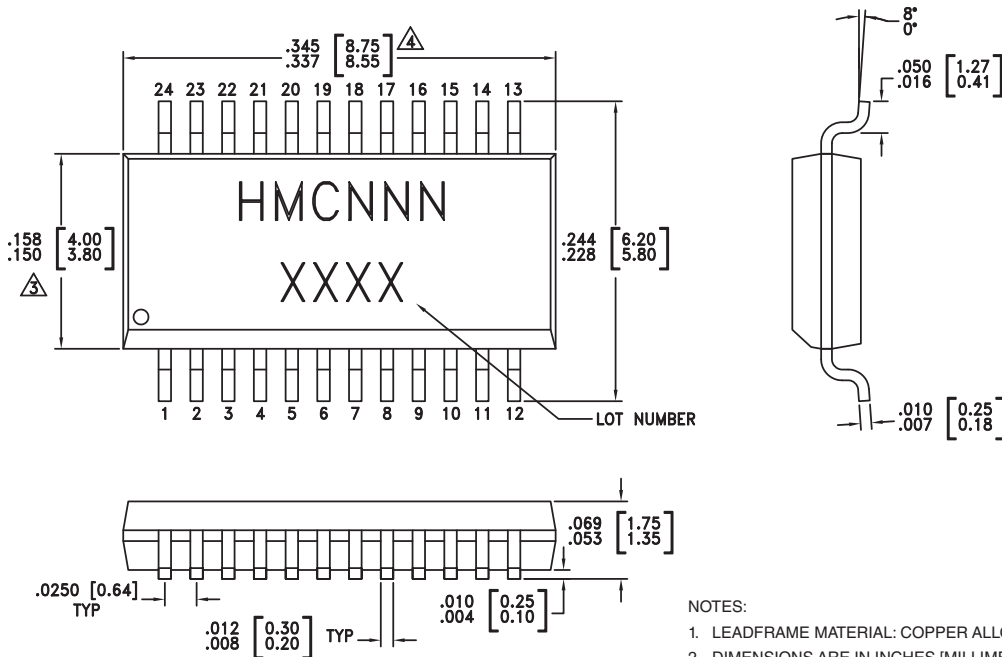

NOTES:

- LEADFRAME MATERIAL: COPPER ALLOY
- DIMENSIONS ARE IN INCHES [MILLIMETERS].
- DIMENSION DOES NOT INCLUDE MOLDFLASH OF 0.15mm PER SIDE.
- DIMENSION DOES NOT INCLUDE MOLDFLASH OF 0.25mm PER SIDE.
- ALL GROUND LEADS MUST BE SOLDERED TO PCB RF GROUND.

Package Information

Part Number	Package Body Material	Leadframe Plating	MSL Rating	Package Marking ^[3]
HMC183QS24	Low Stress Injection Molding Plastic Silica and Silicon Impregnated	Sn/Pb Solder	MSL1 ^[1]	HMC183 XXXX
HMC183QS24E	RoHS-compliant Low Stress Injection Molding Plastic Silica and Silicon Impregnated	100% Matte Tin	MSL1 ^[2]	HMC183 XXXX

[1] Max peak reflow temperature of 235 °C

[2] Max peak reflow temperature of 260 °C

[3] 4-Digit lot number XXXX

For price, delivery, and to place orders, please contact Hittite Microwave Corporation:
20 Alpha Road, Chelmsford, MA 01824 Phone: 978-250-3343 Fax: 978-250-3373

Order On-line at www.hittite.com



v02.0805

HMC183QS24 / 183QS24E

GaAs MMIC SP8T NON-REFLECTIVE SWITCH, DC - 2 GHz



Evaluation Circuit Board

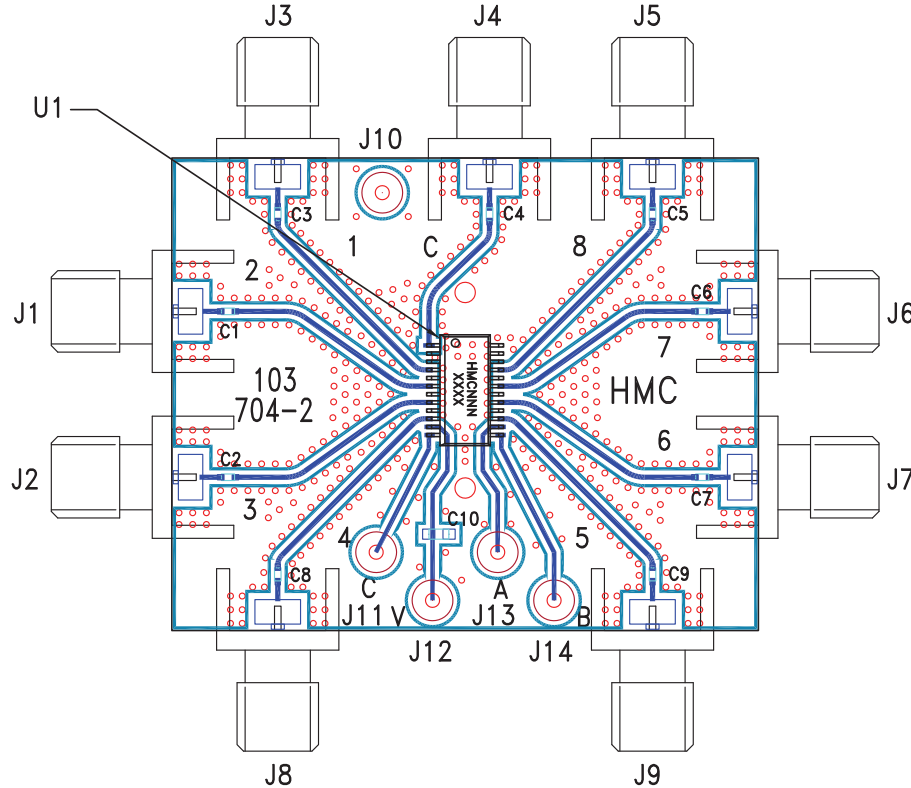

10

SWITCHES - SMT

List of Materials for Evaluation PCB 103706 [1]

Item	Description
J1 - J9	PCB Mount SMA RF Connector
J10 - J14	DC Pin
C1 - C9	100 pF capacitor, 0402 Pkg.
C10	10,000 pF capacitor, 0603 Pkg.
U1	HMC183QS24 / HMC183QS24E SP8T Switch
PCB*	103704 Evaluation PCB

[1] Reference this number when ordering complete evaluation PCB

[2] Circuit Board Material: Rogers 4350

The circuit board used in the final application should be generated with proper RF circuit design techniques. Signal lines at the RF port should have 50 ohm impedance and the package ground leads and package bottom should be connected directly to the ground plane similar to that shown above. The evaluation circuit board shown above is available from Hittite Microwave Corporation upon request.

For price, delivery, and to place orders, please contact Hittite Microwave Corporation:
20 Alpha Road, Chelmsford, MA 01824 Phone: 978-250-3343 Fax: 978-250-3373

Order On-line at www.hittite.com