

## GaAs MMIC 1 WATT POWER AMPLIFIER, 2.3 - 2.8 GHz



### Typical Applications

The HMC755LP4E is Ideal for:

- Cellular/3G & LTE/4G
- WiMAX, WiBro & Fixed Wireless
- Military & SATCOM
- Test Equipment

### Features

- High Gain: 31 dB
- High PAE: 28% @ +33 dBm Pout
- Low EVM: 2.5% @ Pout = +25 dBm with 54 Mbps OFDM Signal
- High Output IP3: +43 dBm
- Integrated Detector & Power Control
- 24 Lead 4x4mm QFN Package: 16mm<sup>2</sup>

### Functional Diagram

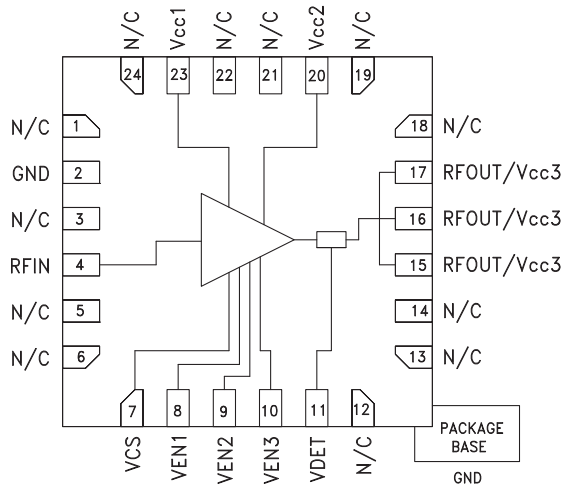

### General Description

The HMC755LP4E is a high gain, high linearity GaAs InGaP HBT MMIC Power amplifier covering 2.3 to 2.8 GHz. The amplifier provides 31 dB of gain and +33 dBm of saturated power from a single +5V supply. The power control pins (VEN1, 2, 3) can be used to reduce the RF output power/quiescent current, or for full power down of the PA. The integrated output power detector (VDET) is internally coupled and requires no external components. For +25 dBm OFDM output power (64 QAM, 54 Mbps), the HMC755LP4E achieves an error vector magnitude (EVM) of only 2.5% making it ideal for WiMAX/LTE/4G Applications. The amplifier is packaged in a compact QFN SMT package and requires a minimum of external matching components.

### Electrical Specifications, $T_A = +25\text{ }^\circ\text{C}$ , $V_{cc1, 2, 3} = +5\text{V}$ , $V_{EN1, 2, 3} = +5\text{V}$ , $V_{cs} = +5\text{V}$

Parameter	Min.	Typ.	Max.	Units
Frequency Range	2.3 - 2.8			GHz
Gain	28	31		dB
Gain Variation Over Temperature		0.05		dB/ °C
Input Return Loss		10		dB
Output Return Loss		7		dB
Output Power for 1dB Compression (P1dB)	28	31		dBm
Saturated Output Power (Psat)		33		dBm
Output Third Order Intercept (IP3) [1]		43		dBm
Error Vector Magnitude @ 2.5 GHz (54 Mbps OFDM Signal @ +22 dBm Pout)		2.5		%
Supply Current (Icc1 + Icc2 + Icc3)	400	480	600	mA
Control Current (Ien1 + Ien2 + Ien3)		16		mA
Bias Current (Ics)		12		mA

[1] Two-tone output power of +25 dBm per tone, 1 MHz spacing.



## HMC755LP4E

### GaAs MMIC 1 WATT POWER AMPLIFIER, 2.3 - 2.8 GHz

**Broadband Gain & Return Loss**

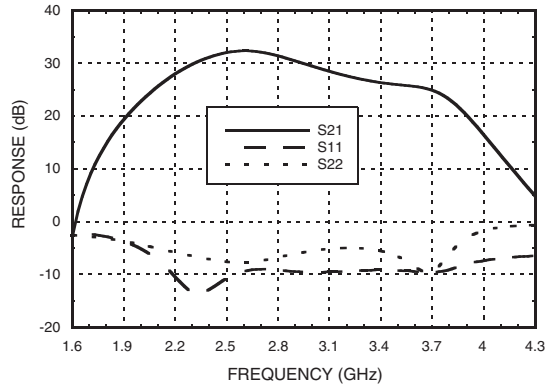

**Gain vs. Temperature**

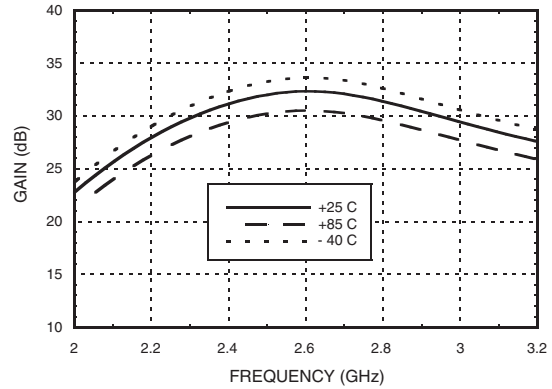

**Input Return Loss vs. Temperature**

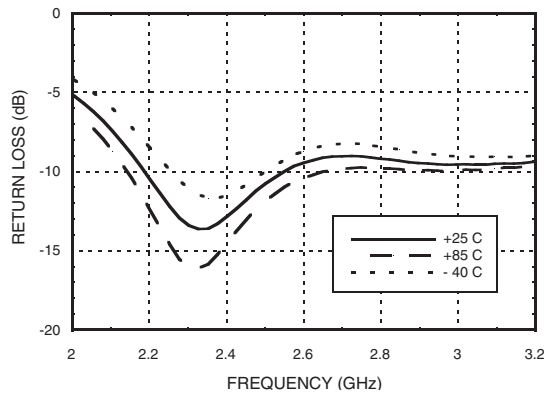

**Output Return Loss vs. Temperature**

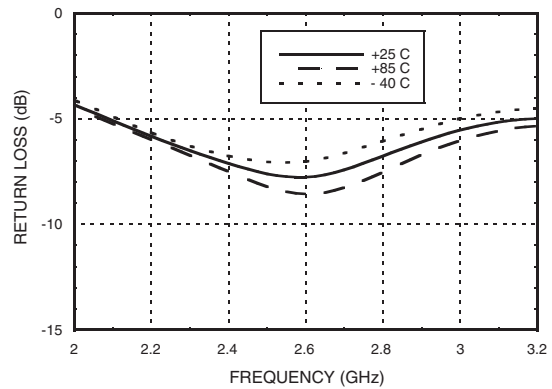

**Reverse Isolation vs. Temperature**

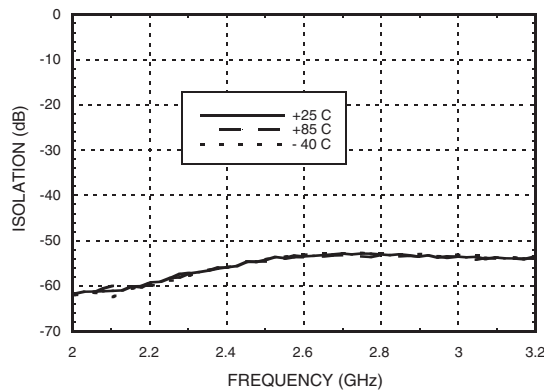



## HMC755LP4E

### GaAs MMIC 1 WATT POWER AMPLIFIER, 2.3 - 2.8 GHz

**P1dB vs. Temperature**

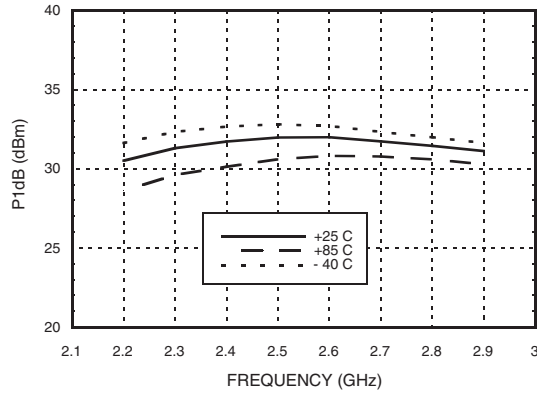

**Psat vs. Temperature**

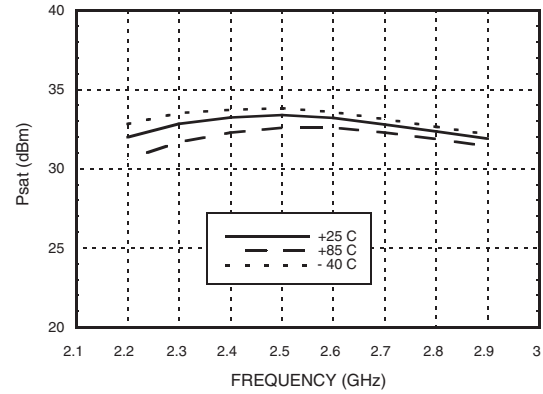

**Output IP3 vs. Temperature @ 26 dBm**

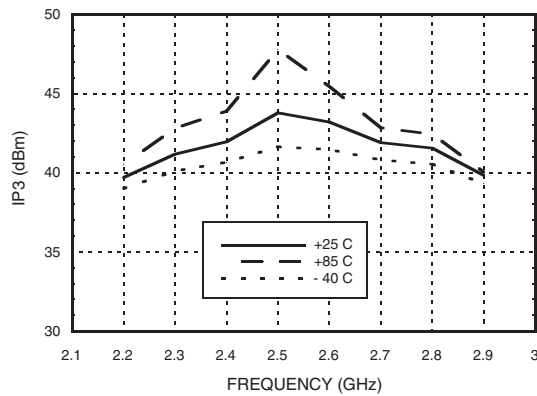

**Output IP3 vs. Temperature @ 2.4 GHz**

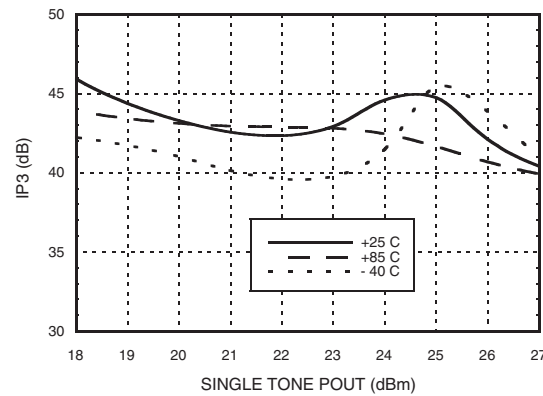

**VDET Output Voltage vs. Temperature**

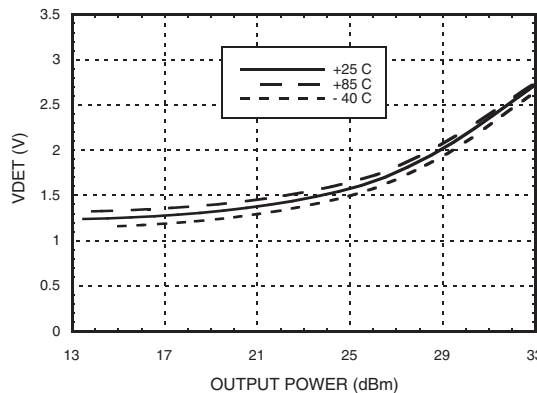

**Power Compression @ 2.5 GHz**

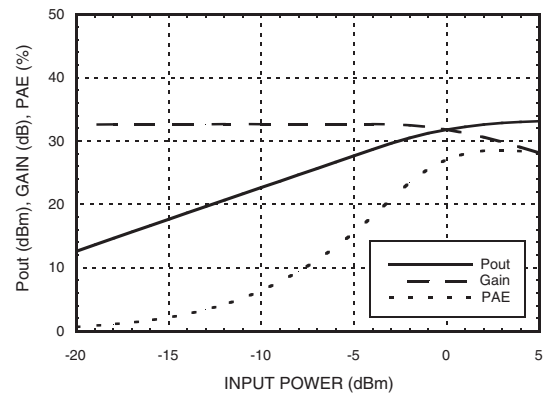



## HMC755LP4E

### GaAs MMIC 1 WATT POWER AMPLIFIER, 2.3 - 2.8 GHz

**Gain & Power vs. Supply Voltage**

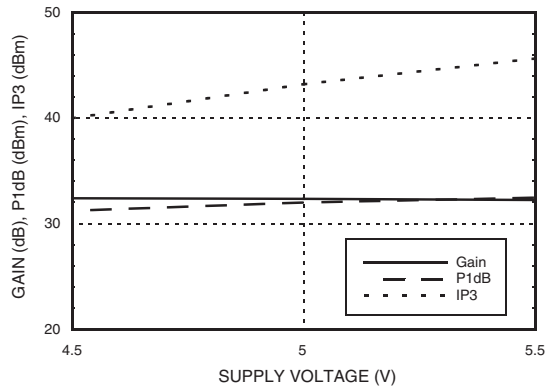

**Noise Figure vs. Temperature**

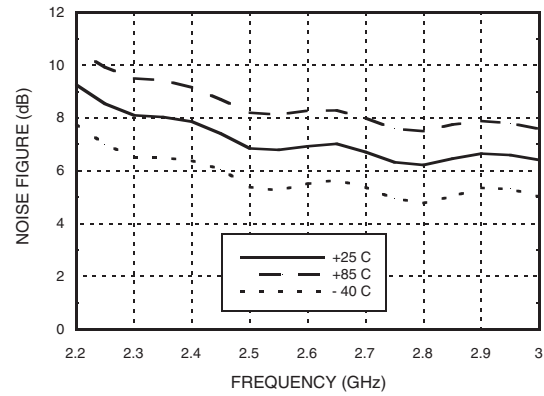

**Power Dissipation**

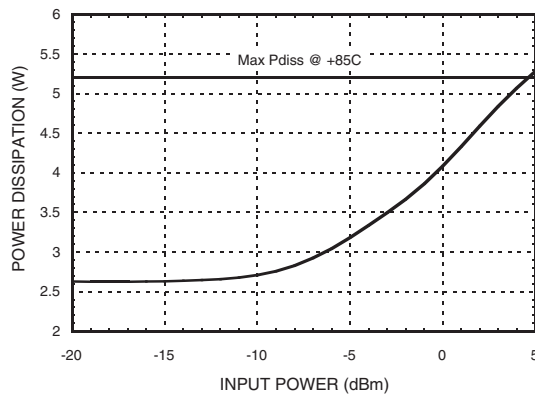

**EVM vs. Frequency  
(54 Mbps OFDM Signal)**

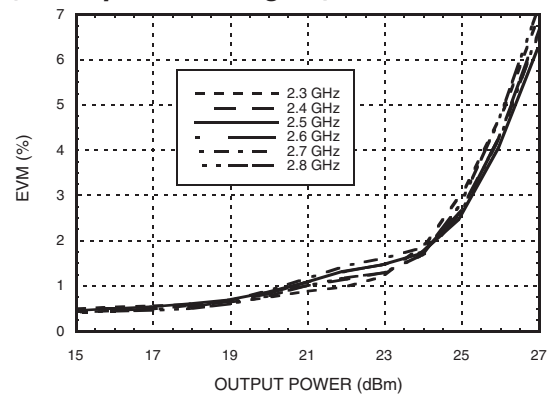

**EVM vs. Temperature @ 2.5 GHz  
(54 Mbps OFDM Signal)**

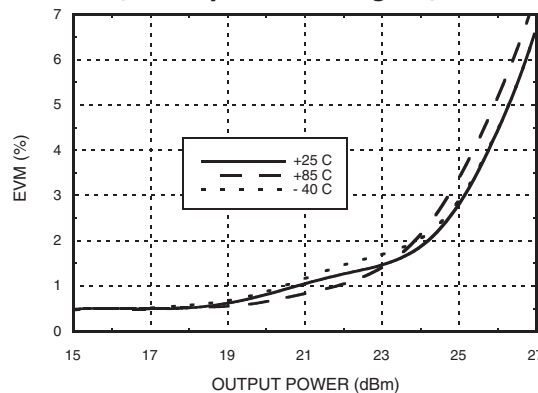

11

LINEAR & POWER AMPLIFIERS - SMT

## GaAs MMIC 1 WATT POWER AMPLIFIER, 2.3 - 2.8 GHz



### Absolute Maximum Ratings

Collector Bias Voltage (Vcc1, Vcc2, Vcc3)	5.5V
Control Voltage (VEN1, 2, 3)	Vcc +0.5
RF Input Power (RFIN)(Vcc = +5V)	+5 dBm
Junction Temperature	150 °C
Continuous Pdiss (T = 85 °C) (derate 80 mW/°C above 85 °C)	5.2 W
Thermal Resistance (junction to ground paddle)	12.5 °C/W
Storage Temperature	-65 to +150 °C
Operating Temperature	-40 to +85 °C

### Typical Supply Current vs. Supply Voltage

Vcc (V)	Icq (mA)
4.5	430
5.0	480
5.5	530



ELECTROSTATIC SENSITIVE DEVICE  
OBSERVE HANDLING PRECAUTIONS

### Outline Drawing

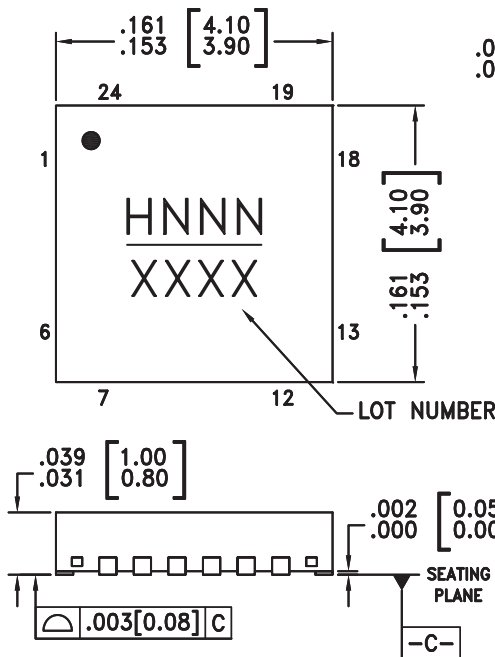

### BOTTOM VIEW

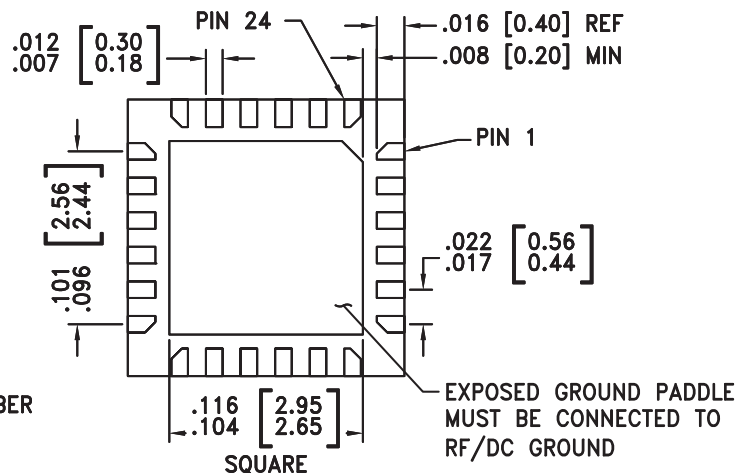

#### NOTES:

- LEADFRAME MATERIAL: COPPER ALLOY
- DIMENSIONS ARE IN INCHES [MILLIMETERS]
- LEAD SPACING TOLERANCE IS NON-CUMULATIVE.
- PAD BURR LENGTH SHALL BE 0.15mm MAXIMUM.  
PAD BURR HEIGHT SHALL BE 0.05mm MAXIMUM.
- PACKAGE WARP SHALL NOT EXCEED 0.05mm.
- ALL GROUND LEADS AND GROUND PADDLE MUST BE SOLDERED TO PCB RF GROUND.
- REFER TO HITTITE APPLICATION NOTE FOR SUGGESTED LAND PATTERN.

### Package Information



Part Number	Package Body Material	Lead Finish	MSL Rating	Package Marking <sup>[1]</sup>
HMC755LP4E	RoHS-compliant Low Stress Injection Molded Plastic	100% matte Sn	MSL3 <sup>[2]</sup>	H755 XXXX

[1] 4-Digit lot number XXXX

[2] Max peak reflow temperature of 260 °C

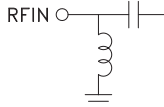
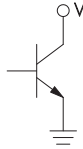
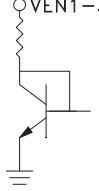

**Pin Descriptions**

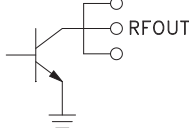
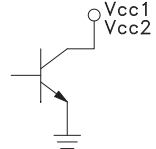
Pin Number	Function	Description	Interface Schematic
1, 3, 5, 6, 12 - 14, 18, 19, 21, 22, 24	N/C	These pins are not connected internally. However, all data shown herein was measured with these pins connected to RF/DC ground.	
2	GND	Ground: Backside of package has exposed metal paddle that must be connected to ground thru a short path. Vias under the device are required.	
4	RFIN	This pin is DC coupled and matched to 50 Ohms.	
7	VCS	DC power supply pin for bias circuitry.	
8 - 10	VEN1 - 3	Power control pins. For max power these pins should be connected to 5V. This voltage can be reduced, or R1-R4 resistor values increased to reduce the quiescent current. For full power down, apply V < 0.5V	
11	VDET	DC voltage output proportional to RFOUT signal.	
15, 16, 17	RFOUT	RF output and DC bias for the output stage. External RF matching, bypass capacitors, and pull up choke are required as shown in the application circuit.	
20	Vcc2	Power supply voltage for the second amplifier stage. External bypass capacitors and pull up choke are required as shown in the application schematic.	
23	Vcc1	Power supply voltage for the first amplifier stage. External bypass capacitors are required as shown in the application schematic.	



#### Evaluation PCB

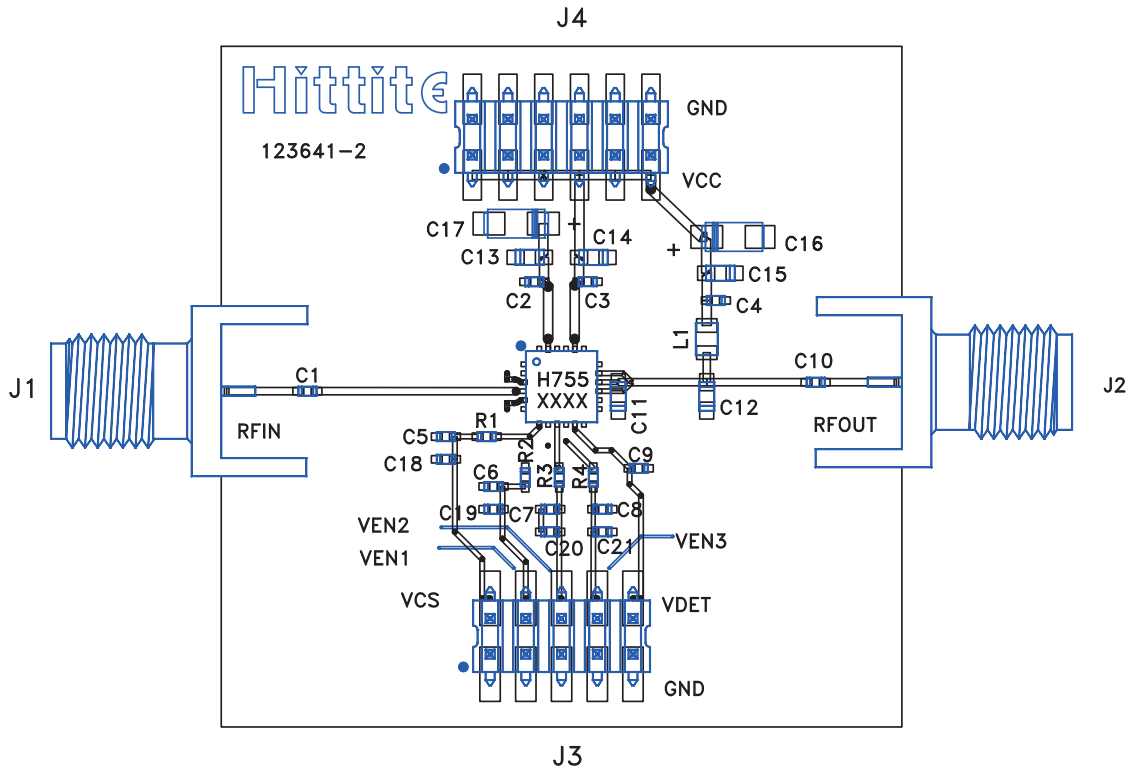

#### List of Materials for Evaluation PCB 123643 [1]

Item	Description
J1, J2	PCB Mount SMA Connector
J3, J4	2MM Molex Header
C1 - C10	100 pF Capacitor, 0402 Pkg.
C11	3 pF Capacitor Ultra Low ESD, 0603 Pkg.
C12	1.5 pF Capacitor Ultra Low ESD, 0603 Pkg.
C13 - C15	1000 pF Capacitor, 0603 Pkg.
C16	2.2 μF Capacitor, Tantalum
C17	4.7 μF Capacitor, Tantalum
C18 - C12	10000 pF Capacitor, 0402 Pkg.
L1	10 nH Inductor, 0603 Pkg.
R1	0 Ohm Resistor, 0402 Pkg.
R2	200 Ohm Resistor, 0402 Pkg.
R3	300 Ohm Resistor, 0402 Pkg.
R4	130 Ohm Resistor, 0402 Pkg.

Item	Description
U1	HMC755LP4E Power Amplifier
PCB [2]	123641 Eval Board

[1] Reference this number when ordering complete evaluation PCB

[2] Circuit Board Material: Rogers 4350 or Arlon 25FR

The circuit board used in the application should use RF circuit design techniques. Signal lines should have 50 Ohm impedance while the package ground leads and exposed paddle should be connected directly to the ground plane similar to that shown. A sufficient number of via holes should be used to connect the top and bottom ground planes and the evaluation board should be mounted to an appropriate heat sink. The evaluation circuit board shown is available from Hittite upon request.



## HMC755LP4E

### GaAs MMIC 1 WATT POWER AMPLIFIER, 2.3 - 2.8 GHz

#### Application Circuit

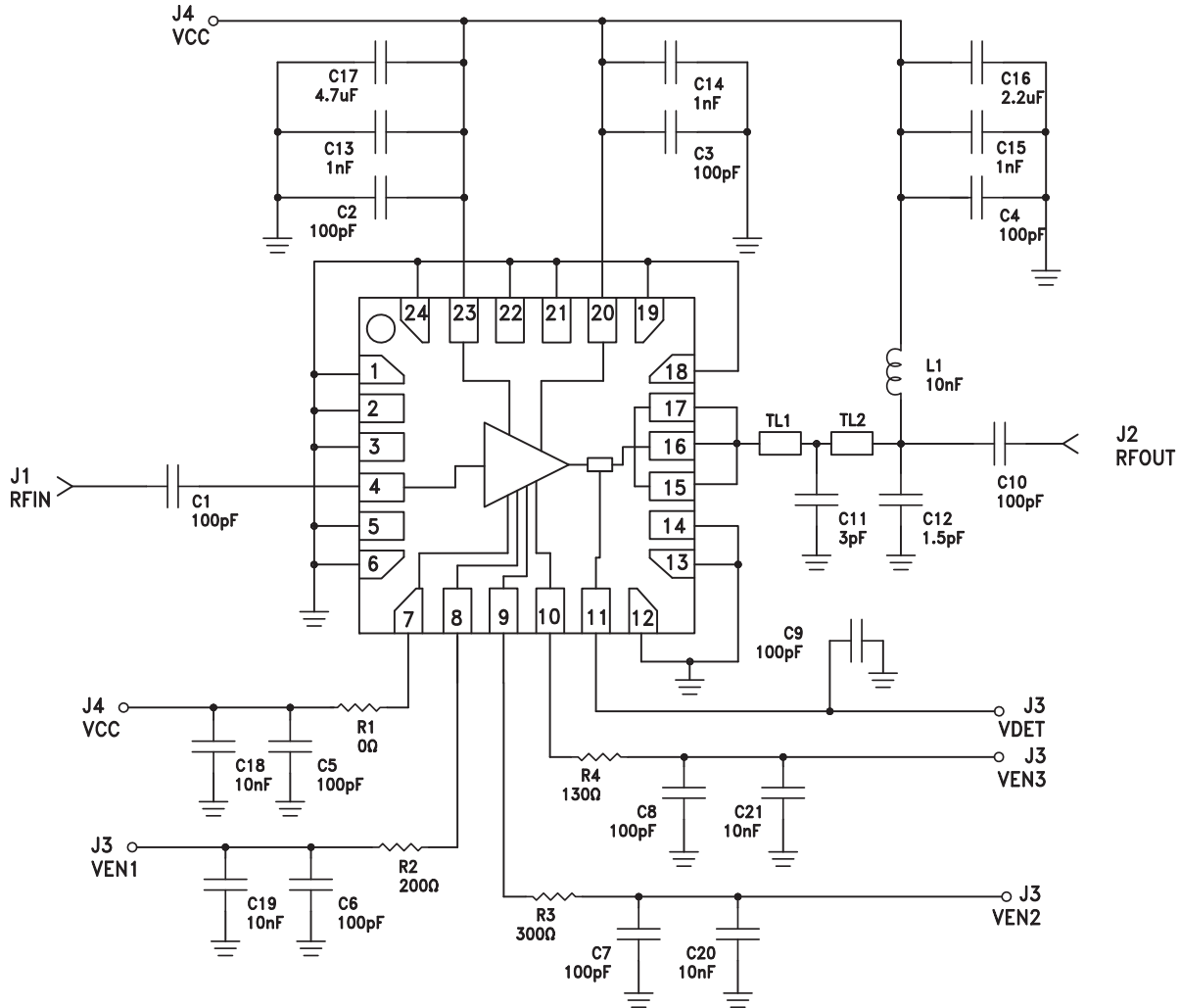

	TL1	TL2
Impedance	27 Ohm	50 Ohm
Physical Length	0.033"	0.133"
Electrical Length	6.6°	38°

PCB Material: 10 mil Rogers 4350 or Arlon 25FR