

Technology at Your Service

Integrated Microwave provides a full range of engineering expertise and services, including:

■ Computer-Aided Capabilities

- Synthesis/Analysis
- Design
- Engineering
- Manufacturing
- Testing
- QA Tracking

These capabilities are fully utilized in providing filter solutions within the following parameters:

■ Transfer Functions

- Frequency Domain
 - Chebyshev*
 - Butterworth*
 - Elliptic (Cauer)*
 - Pseudo-Elliptic*
- Transitional
 - Gaussian (6 dB)*
 - Gaussian (12 dB)*
- Time Domain
 - Gaussian*
 - Bessel*
 - Linear Phase (.05°)*
 - Linear Phase (.5°)*

■ Frequencies

- DC to 20 GHz

■ Technologies

- Ceramic
- Lumped Element
- Helical
- Compline
- Interdigital
- High Power

Assuring Design Compliance

Compliance with design parameters can only occur if all phases from modeling to production are monitored for strict conformance to customer requirements and design standards. Integrated Microwave takes pride in the close and constant attention paid to every aspect of the design process, from the acquisition of raw materials to final inspection and shipping of the finished product. Every component is continuously monitored for electrical and physical performance, workmanship and compliance to applicable specifications.

Unit-to-unit repeatability is assured by precision fabrication, certified soldering and fast, accurate testing. Complete in-house environmental testing facilities include thermal shock, thermal cycling, insulation resistance and hermeticity. Additional testing may include high-level vibration, mechanical shock, constant acceleration, Particle Impact Noise Detection (PIND) and radiographic inspection.

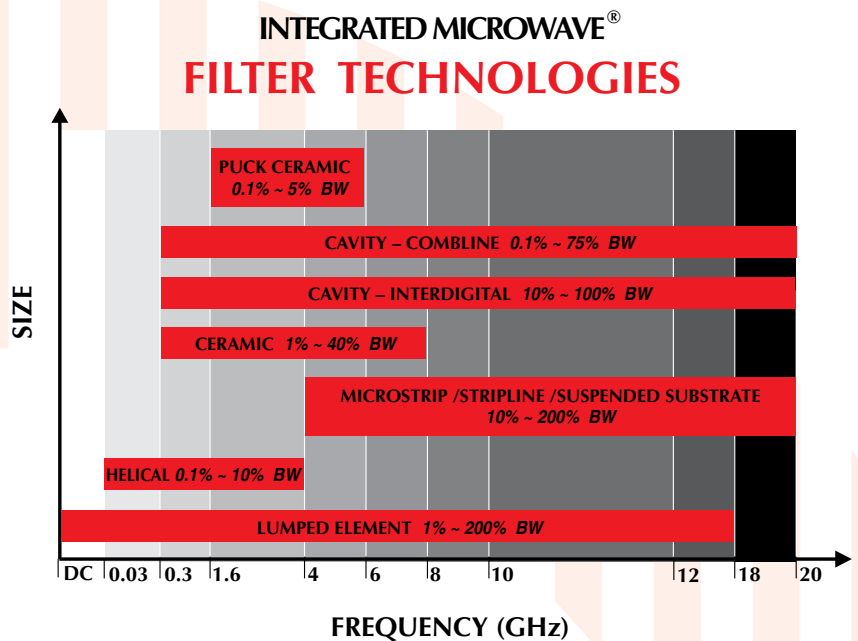

INTEGRATED MICROWAVE®



Tect Electronics

The authorized distributor in the Greater China Region

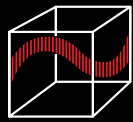

Ceramic Technology

High Performance Ceramic Filters & Diplexers

- **Bandwidth:** 1% ~ 40%
- **Frequency Range:** 200 MHz ~ 10 GHz
- **Available Packaging:** Connectorized, SMT, Pin

Materials

Ceramic components are manufactured using extruded or pressed powder ceramic stock with dielectric constants of 8, 20, 36, 45, 84 or 98. Resonators are pressed in profiles from 3mm to 18mm, then metallized with thick-film silver.

Design and Performance

Compliance with design and performance parameters can only occur if all project phases, from modeling to production, are monitored for strict conformance to customer requirements and design standards. Electrical and mechanical parameters, including size, insertion loss and rejection, are constantly checked, so that completed components represent the highest standards of workmanship and compliance to applicable specifications.

Assembly

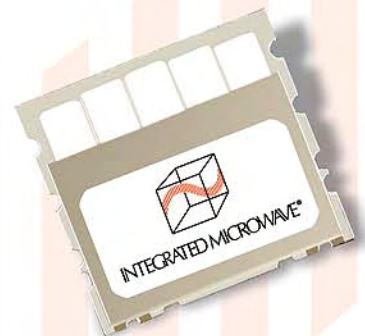
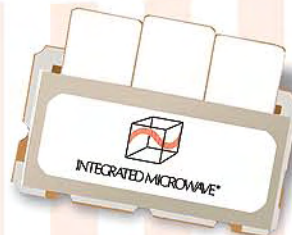
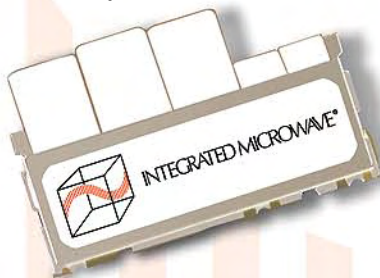

The assembly process includes the design and fabrication of the component's coupling structure, housing and I/O configuration. Resonator frequency is adjusted and reflow operations are performed. The unit is cleaned and inspected, then sent on for final testing.

Testing

Design and performance requirements are closely monitored throughout the manufacturing process. All IMC products are 100% tested; test/tune stations incorporate ATE testing to ensure 100% compliance with customer specifications.

Product Evolution - New Technology

Integrated Microwave is constantly seeking new ways to enhance product performance and manufacturing techniques. Ongoing research focuses on ways to reduce parts count and costs for greater cost effectiveness, extension of product frequencies with new ceramic powder formulations, and use of robotics for increased automation of manufacturing processes.

Ceramic Band Reject Filters



Tect Electronics

The authorized distributor in the Greater China Region

Designers can achieve the maximum rejection from one frequency band to another with the minimum number of filter sections by using band reject filters rather than bandpass filters. Another distinct benefit of band reject filters is that their amplitude and phase flatness can be superior to other options.

Disadvantages of band reject filters include very little out-of-band rejection and degraded VSWR performance.

Band reject filters can be considered for diplexing if the phase between the two filters is tightly controlled. The graph below shows a typical comparison of a band reject filter and bandpass filter with the same number of sections. The passband and band of rejection of each filter is 2%, and separation of the bandpass and band rejection is 1%.

Both filters are the same physical size; the band reject filter is more difficult to build and slightly more expensive.

Ceramic Filters with Notches

Transmission zeros may be incorporated into ceramic filters to achieve tradeoffs that can sometimes benefit system design. This class of filters is sometimes referred to as “elliptical.”

If a designer needs to minimize the physical size and cost of a filter, and can sacrifice some out-of-band rejection, steep attenuation slopes close to the passband can be achieved with transmission zeros. In the example, with 2% bandwidth, a standard 4 section filter is compared with a 3 section filter with a notch. The standard filter has

the “monotonic” rejection typical of a Chebyshev filter. The notch filter has a steeper rejection slope on the high side (it could have been low side or both sides, but the rejection slope rises again before it eventually falls).

Transmission zero filters give the designer a way to trade off far out-of-band rejection for near out-of-band rejection. Typically, these filters are of the same complexity and price as standard filters.

Using standard filters, filters with transmission zeros and band reject filters, along with special matching networks, the performance of IMC diplexers can surpass the insertion loss and rejection of stand-alone filter designs.

Diplexers

When the filters of a diplexer are properly phase matched, each channel acts as a “trap” to the other channel, thus achieving additional adjacent channel rejection of about 5 dB.

Regarding diplexer packaging, the best and most cost effective electrical layout is an in-line design where the antenna (or common) connection is in the middle, and each output is at an opposite end of the row of ceramic resonators. Alternate “Y” package layouts usually require more expensive RF-sealed packages.

IMC has many existing filter and diplexer designs. Contact us with your requirements.

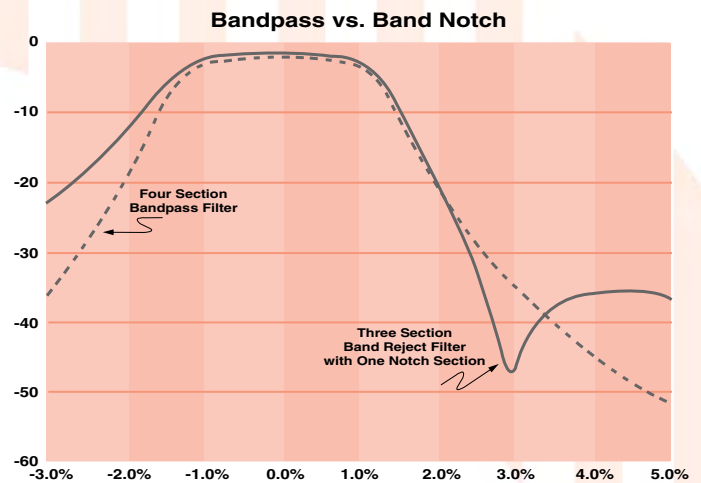
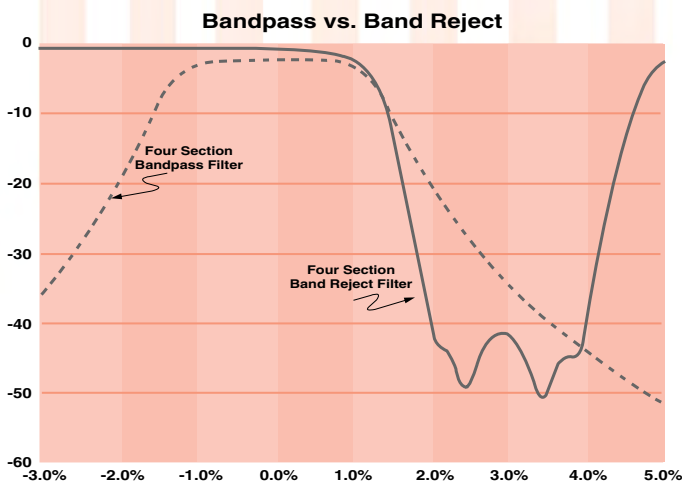

INTEGRATED MICROWAVE®



Tect Electronics

The authorized distributor in the Greater China Region

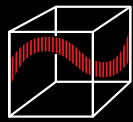

Ceramic Technology

IMC Ceramic Filter Environmental Specifications

All IMC ceramic filters are manufactured under exacting quality assurance and control standards. As a minimum, they will meet electrical specifications after being subjected to the following physical and environmental tests of MIL-STD-202, unless otherwise noted:

	Spec	MIL-STD-202 Method Condition	
Temperature, Operating	-20 to +70°C (Commercial) -54 to +85°C (Military) -55 to +125°C (Special)	-	-
Temperature, Storage	-55 to +125°C	-	-
Altitude	150,000 ft.	105	E
Humidity	90% RH, 65°C	106	-
Thermal Shock -55 to +100°C	-55 to +125°C	107	B
Solderability	95% Coverage	208	-
Solvent Resistance		215	-

Operating Temperature Stability

IMC ceramic filters have excellent temperature stability, typically less than 5 ppm/°C.

Tape and Reel

Tape and reel packaging with bar-coded labels is available.



Tape and reel packaging for automated assembly

Soldering to IMC Ceramic Filters

IMC uses high temperature solder to assemble internal components for both leaded and SMT ceramic filters. It is recommend that customers use 63Sn/37Pb or equivalent for attaching both signal and ground connections.

During solder installation, do not exceed the **absolute maximum ratings**:

Pin Temperature: +260°C (10 seconds)

Body Temperature: +215°C (maximum)



Tect Electronics

The authorized distributor in the Greater China Region

Package Styles

■ Surface Mount/Leadless – S11

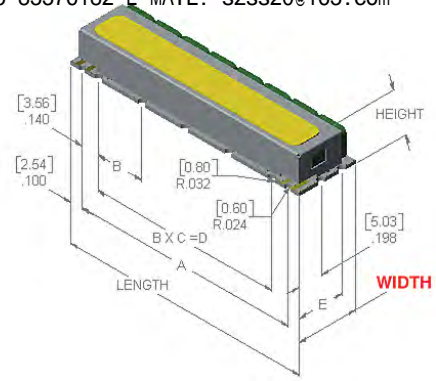

$$\text{Width (Inches)} = \frac{2951}{f_O \text{ (MHz)} \times \sqrt{\text{dielectric constant}}}$$

Res. Profile	Sections	Height		Length		A		B	C		D		E	
		Inches	mm	Inches	mm	Inches	mm	Inches	mm	Inches	mm	Inches	mm	
3 mm	5	0.170	4.32	0.690	17.53	0.210	5.33	1	0.21	5.33	0.105	2.67	0.280	7.11
3 mm	6	0.170	4.32	0.810	20.57	0.330	8.38	1	0.33	8.38	0.165	4.19	0.280	7.11
3 mm	7	0.170	4.32	0.930	23.62	0.450	11.43	1	0.45	11.43	0.225	5.72	0.280	7.11
3 mm	8	0.170	4.32	1.050	26.67	0.285	7.24	2	0.57	14.48	0.285	7.24	0.280	7.11
4 mm	2	0.210	5.33	0.410	10.41	**	**	1	**	**	**	**	0.280	7.11
4 mm	3	0.210	5.33	0.570	14.48	**	**	1	**	**	**	**	0.280	7.11
4 mm	4	0.210	5.33	0.730	18.54	0.250	6.35	1	0.25	6.35	0.125	3.18	0.280	7.11
4 mm	5	0.210	5.33	0.890	22.61	0.410	10.41	1	0.41	10.41	0.205	5.21	0.280	7.11
4 mm	6	0.210	5.33	1.050	26.67	0.285	7.24	2	0.57	14.48	0.285	7.24	0.280	7.11
4 mm	7	0.210	5.33	1.210	30.73	0.365	9.27	2	0.73	18.54	0.365	9.27	0.280	7.11
4 mm	8	0.210	5.33	1.370	34.80	0.445	11.30	2	0.89	22.61	0.445	11.30	0.280	7.11
5 mm	2	0.250	6.35	0.490	12.45	0.010	**	1	0.01	0.25	**	**	0.380	9.65
5 mm	3	0.250	6.35	0.690	17.53	0.210	5.33	1	0.21	5.33	0.105	2.67	0.380	9.65
5 mm	4	0.250	6.35	0.890	22.61	0.410	10.41	1	0.41	10.41	0.205	5.21	0.380	9.65
5 mm	5	0.250	6.35	1.090	27.69	0.305	7.75	2	0.61	15.49	0.305	7.75	0.380	9.65
5 mm	6	0.250	6.35	1.290	32.77	0.405	10.29	2	0.81	20.57	0.405	10.29	0.380	9.65
5 mm	7	0.250	6.35	1.490	37.85	0.337	8.55	3	1.01	25.65	0.505	12.83	0.380	9.65
5 mm	8	0.250	6.35	1.690	42.93	0.403	10.24	3	1.21	30.73	0.605	15.37	0.380	9.65
6 mm	2	0.290	7.37	0.570	14.48	0.090	**	1	0.09	2.29	**	**	0.380	9.65
6 mm	3	0.290	7.37	0.810	20.57	0.330	8.38	1	0.33	8.38	0.165	4.19	0.380	9.65
6 mm	4	0.290	7.37	1.050	26.67	0.285	7.24	2	0.57	14.48	0.285	7.24	0.380	9.65
6 mm	5	0.290	7.37	1.290	32.77	0.405	10.29	2	0.81	20.57	0.405	10.29	0.380	9.65
6 mm	6	0.290	7.37	1.530	38.86	0.350	8.89	3	1.05	26.67	0.525	13.34	0.380	9.65
6 mm	7	0.290	7.37	1.770	44.96	0.430	10.92	3	1.29	32.77	0.645	16.38	0.380	9.65
6 mm	8	0.290	7.37	2.010	51.05	0.383	9.72	4	1.53	38.86	0.765	19.43	0.380	9.65
8 mm	2	0.370	9.40	0.730	18.54	0.250	6.35	1	0.25	6.35	0.125	3.18	0.380	9.65
8 mm	3	0.370	9.40	1.050	26.67	0.285	7.24	2	0.57	14.48	0.285	7.24	0.380	9.65
8 mm	4	0.370	9.40	1.370	34.80	0.445	11.30	2	0.89	22.61	0.445	11.30	0.380	9.65
8 mm	5	0.370	9.40	1.690	42.93	0.403	10.24	3	1.21	30.73	0.605	15.37	0.380	9.65
8 mm	6	0.370	9.40	2.010	51.05	0.383	9.72	4	1.53	38.86	0.765	19.43	0.380	9.65
8 mm	7	0.370	9.40	2.330	59.18	0.463	11.75	4	1.85	46.99	0.925	23.50	0.380	9.65
8 mm	8	0.370	9.40	2.650	67.31	0.434	11.02	5	2.17	55.12	1.085	27.56	0.380	9.65
10 mm	2	0.450	11.43	0.890	22.61	0.410	10.41	1	0.41	10.41	0.205	5.21	0.380	9.65
10 mm	3	0.450	11.43	1.290	32.77	0.405	10.29	2	0.81	20.57	0.405	10.29	0.380	9.65
10 mm	4	0.450	11.43	1.690	42.93	0.403	10.24	3	1.21	30.73	0.605	15.37	0.380	9.65
10 mm	5	0.450	11.43	2.090	53.09	0.403	10.22	4	1.61	40.89	0.805	20.45	0.380	9.65
10 mm	6	0.450	11.43	2.490	63.25	0.402	10.21	5	2.01	51.05	1.005	25.53	0.380	9.65
10 mm	7	0.450	11.43	2.890	73.41	0.482	12.24	5	2.41	61.21	1.205	30.61	0.380	9.65
10 mm	8	0.450	11.43	3.290	83.57	0.468	11.90	6	2.81	71.37	1.405	35.69	0.380	9.65
12 mm	2	0.530	13.46	1.050	26.67	0.285	7.24	2	0.57	14.48	0.285	7.24	0.380	9.65
12 mm	3	0.530	13.46	1.530	38.86	0.350	8.89	3	1.05	26.67	0.525	13.34	0.380	9.65
12 mm	4	0.530	13.46	2.010	51.05	0.383	9.72	4	1.53	38.86	0.765	19.43	0.380	9.65
12 mm	5	0.530	13.46	2.490	63.25	0.402	10.21	5	2.01	51.05	1.005	25.53	0.380	9.65
12 mm	6	0.530	13.46	2.970	75.44	0.498	12.65	5	2.49	63.25	1.245	31.62	0.380	9.65
12 mm	7	0.530	13.46	3.450	87.63	0.495	12.57	6	2.97	75.44	1.485	37.72	0.380	9.65
12 mm	8	0.530	13.46	3.930	99.82	0.493	12.52	7	3.45	87.63	1.725	43.82	0.380	9.65
18 mm	2	0.770	19.56	1.530	38.86	0.350	8.89	3	1.05	26.67	0.525	13.34	0.380	9.65
18 mm	3	0.770	19.56	2.250	57.15	0.443	11.24	4	1.77	44.96	0.885	22.48	0.380	9.65
18 mm	4	0.770	19.56	2.970	75.44	0.498	12.65	5	2.49	63.25	1.245	31.62	0.380	9.65
18 mm	5	0.770	19.56	3.690	93.73	0.459	11.65	7	3.21	81.53	1.605	40.77	0.380	9.65
18 mm	6	0.770	19.56	4.410	112.01	0.491	12.48	8	3.93	99.82	1.965	49.91	0.380	9.65
18 mm	7	0.770	19.56	5.130	130.30	0.465	11.81	10	4.65	118.11	2.325	59.06	0.380	9.65
18 mm	8	0.770	19.56	5.850	148.59	0.488	12.40	11	5.37	136.40	2.685	68.20	0.380	9.65

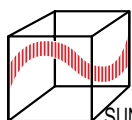

INTEGRATED MICROWAVE®

For other resonator profiles and connectors, please contact factory.



Tect Electronics

The authorized distributor in the Greater China Region

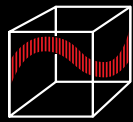

Ceramic Products

Package Styles

■ Surface Mount/Leadless – S11M

$$\text{Width (Inches)} = \frac{2951}{f_0 \text{ (MHz)} \times \sqrt{\text{dielectric constant}}}$$

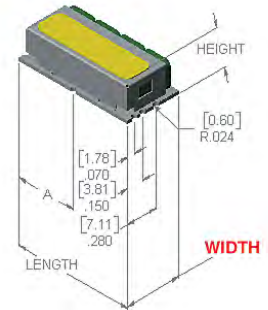

Res. Profile	Sections	Height		Length		A	
		Inches	mm	Inches	mm	Inches	mm
3 mm	2	0.170	4.32	0.330	8.38	0.165	4.19
3 mm	3	0.170	4.32	0.450	11.43	0.225	5.72
3 mm	4	0.170	4.32	0.570	14.48	0.285	7.24

For other resonator profiles and connectors, please contact factory.

