

Quartz Force Links

for Measuring Dynamic and Quasistatic Tensile and Compression Forces

Type 9301B ... 9371B

The Force Link is used to measure dynamic or quasistatic tensile or compression forces. It has a high rigidity and thus a high natural frequency. The high resolution allows to measure low dynamical changes of large forces.

- Calibrated force link
- Simple installation
- Centering seats for exact installation
- Ground-isolated
- Accessories for optimum force introduction

Description

The force sensor is mounted under preload between two nuts and, therefore can measure compression and tensile forces. The quartz element yields an electric charge which is proportional to the force. This is picked off by an electrode and transferred via a connector. The charge signal is fed via a screened cable to a charge amplifier, which converts it into a proportional output voltage. An appropriate evaluation circuit can record and further process the measurand.

The sensor is moulded ground-isolated. This largely eliminates ground loop problems.



Application

As a result of its great rigidity, the force link is particularly suitable for measuring rapidly changing tensile and compression forces. The elastic behaviour of the test object is practically not influenced. Quasistatic measurements, are possible, too. **The force link is supplied calibrated.** After correct installation, it is immediately ready for use without recalibration.

Technical Data

Type		9301B	9311B	9321B	9331B	9341B	9351B	9361B	9371B
Range F_z	kN	±2,5	±5	±10	±20	±30	±40	±60	±120
Calibrated partial range	N	25	50	100	200	300	400	600	1 200
Overload	kN	±2,75	±5,5	±11	±22	±33	±44	±66	±132
Rigidity	KN/ μ m	≈0,44	≈0,73	≈1,1	≈1,6	≈2,1	≈2,4	≈3,1	≈6,1
Natural frequency	kHz	≈90	≈70	≈55	≈45	≈40	≈33	≈28	≈22
Capacitance	pF	≈8	≈23	≈37	≈55	≈65	≈65	≈150	≈200
Torque $M_{z \max}$ ($F_{x,y}, F_z = 0$)	N·m	1,5	4,7	17,6	37	70	113	230	703
Bending moment ($F_z = 0$)	N·m	4,2	10,8	53	128	218	358	830	2 829
Shear force $F_{xy \max}$ (no tensile forces)	kN	0,26	0,56	1,35	2,5	3,6	4,8	8	19
Weight	g	14	28	90	170	330	480	1 020	2 500

9301B_000-107e-01_14

General Technical Data

Sensitivity	pC/N	≈-4 ^{*)}
Threshold	N	≤0,02
Linearity including hysteresis	% FSO	≤±0,5
Isolation resistance	Ω	≥5·10 ¹³
Ground-isolation	MΩ	≥100
Temperature coefficient	%/°C	-0,02
Operating temperature range		
connection	°C	-40 ... 120
Degree of protection EN60529		
with connected cable	IP	65
with cable Type 1983AD... and welded sensor	IP	67

*) Type 9301B: ≈-3,2 pC/N

Dimensions

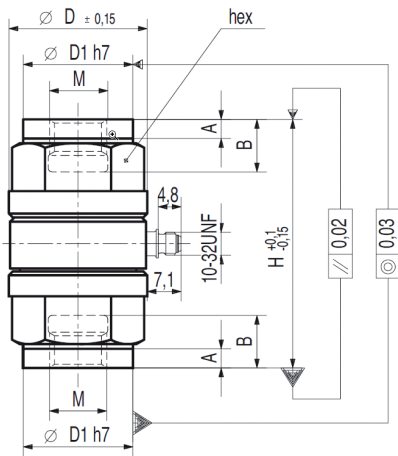

Mounting

The contact faces which transmit the force to the force link must be flat, rigid and clean. The fixing bolts must not touch the bottom of the threaded holes of the force link. A play S (see fig. A, page 3) of at least 0,5 mm must be assured. The bolt must be tightened sufficiently as to avoid that a gap could open between the contact faces under the highest tensile force.

The force link has centering shoulders on both ends which precise mounting easier.

Type	D	D1	H	A	B	hex	M
9301B	11	8,5	25	2	5	9	M5
9311B	15	12,5	30	3	5	13	M6
9321B	23	18	45	5	10	19	M10
9331B	29	23	52	5	11	24	M12
9341B	35	31	62	6	14	32	M16
9351B	41	35	72	7	18	36	M20
9361B	53	45	88	9	22	46	M24
9371B	76	64	108	10	28	65	M30

Dimensions of Types 9301B ... 9371B

Examples of Use

Automobile industry

- Safety technology, monitoring of collision forces
- Mechanical shocks in chassis
- Forces on balancing machines

Material testing

- Impact testing, alternate strength testing

Machine tools

- Monitoring on presses, punching, embossing and welding machines
- Force measurements on longitudinal guideways

General machine building

- Monitoring of supporting forces (force oscillations) on machinery mounted on damping elements.
- Clamping processes, e.g. force sensor combined with hydraulic cylinder
- Joining technique (insertion, press fit of components)

Quality control

- Force measurements on switches
- Monitoring of automatic assembly machines

Force Introduction

As far as possible, this should be concentric to the axis. Eccentric force introduction, bending moments, torques and shear forces are permitted only to a certain extent.

Force Link with SCS Calibration Certificate

Kistler is the calibration laboratory no. 049 accredited by the SCS (Swiss Calibration Service) for force. Therefore, the force links can be supplied (at an extra charge) with an SCS Calibration Certificate. They can then be used e. g. as reference standards in an internal calibration service. Only the range for compression force will be calibrated (100 %FS, 10 %FS and 1 %FS). We recommend to use the force distribution cap and the flange (see page 4) to assure a good reproducibility of the measurements.

9301B_000-107e-01_14

Mounting Examples, Different Types of Force Introduction

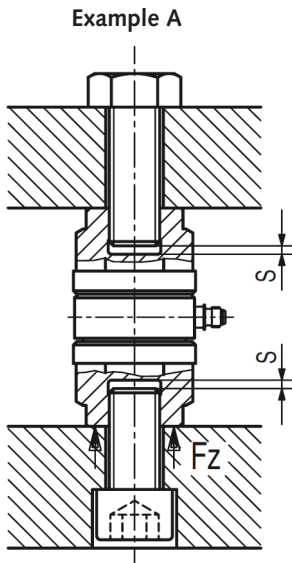

Force introduction of compression forces.

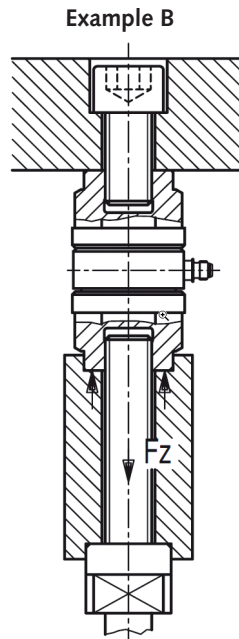

Loading from tensile and compression forces via an extension piece. The pre-loading force on the sleeve must not be less than a minimum value under the effect of tensile forces.

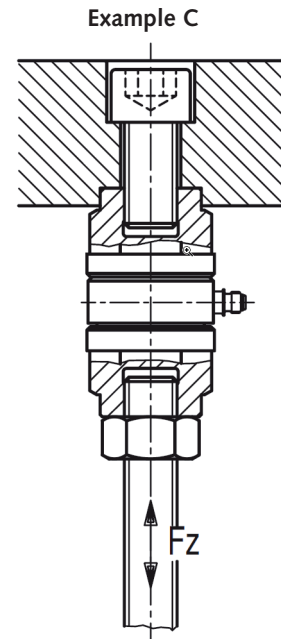

Force introduction of tensile and compression forces directly onto the threaded connection. In this case, a lock nut should always be used.

Example D

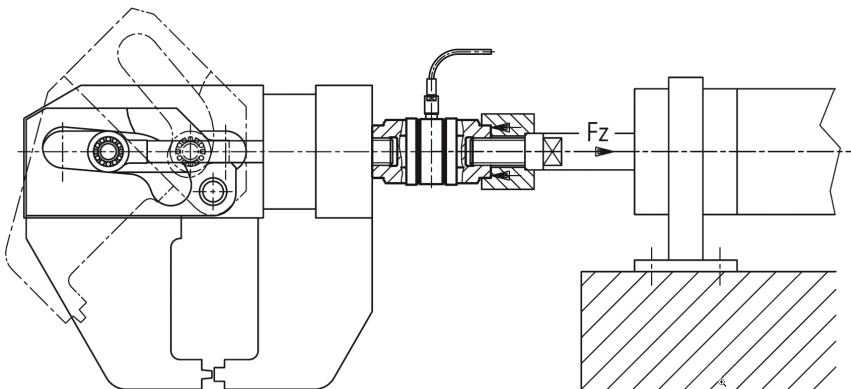

Mounting example of a force link in a hydraulic clamping device. Monitoring of tensile and compression forces.

9301B_000-107e-01_14

Force Distributing Cap and Flange

A force distributing cap and a flange can be used in combination with the force link to provide optimum force introduction. These components are also manufactured as precision parts and have a surface hardness of 400 ... 490 HV (Vickers).

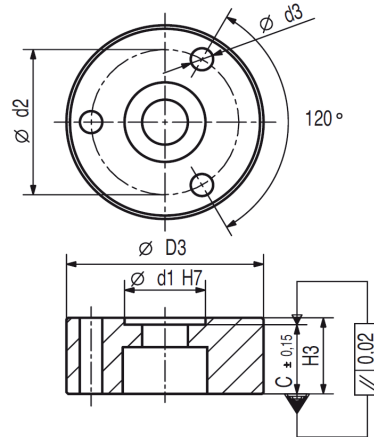
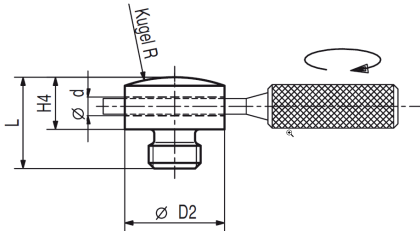

Distributing cap Type 9500A...
 The force distributing cap can be screwed in with a cylindrical tool.

Flange Type 9501A...
 A socket head cap screw is supplied with the flange.

Type	Distribut. cap	D2	L	H4	R	d
9301B	9500A0	8,5	8	4	R10	2,2
9311B	9500A1	12,5	10	6	R15	3,2
9321B	9500A2	18	17	9	R25	4,3
9331B	9500A3	23	21	12	R35	4,3
9341B	9500A4	31	28	15	R45	6,4
9351B	9500A5	35	33	18	R50	6,4
9361B	9500A6	45	41	22	R65	8,4
9371B	9500A7	64	57	32	R90	8,4

Type	Flange	D3	H3	d1	d2	d3	C	H1 (Fig. 1)	H2 (Fig. 2)
9301B	9501A0	25	9	8,5	18	3,2	8	37	41
9311B	9501A1	34	11	12,5	24	4,3	9	45	48
9321B	9501A2	44	18	18	33	5,3	16	70	77
9331B	9501A3	56	22	23	42	6,4	20	84	92
9341B	9501A4	70	29	31	52	8,4	27	104	116
9351B	9501A5	84	37	35	62	10,5	35	125	142
9361B	9501A6	102	44	45	77	13	42	152	172
9371B	9501A7	136	53	64	106	17	51	191	210

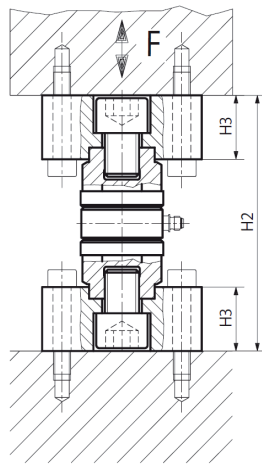
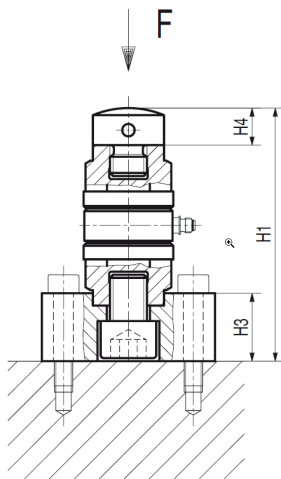

Fig. 1
 Force link with flange and pressure distributing cap. Insert for compression force loading.

Fig. 2
 Force link with flanges fitted on both sides. Insert for compression force loading.

9301B_000-107e-01_14

Connection

Only high-insulation coaxial cables with low capacitance producing only very low triboelectricity during movement must be used for connecting piezoelectric sensors. For industrial environments, we recommend using the types listed in the Accessories. For more stringent requirements in a harsh environment, the industrial, integrated cable connector KIAG 10-32 with O-ring is used. If required, the connector can be seal welded to the sensor case.

Connecting Cable for Sensors with KIAG 10-32 neg. Connector Type 1631C...

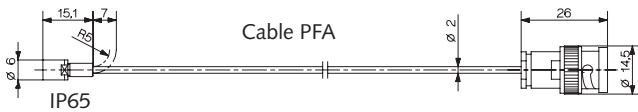



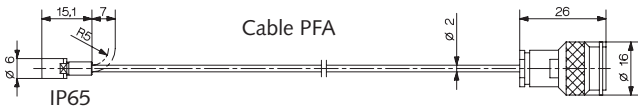



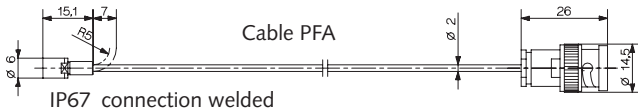

Connecting Cable for Sensors with KIAG 10-32 neg. Connector Type 1941A...



Connecting Cable for Sensors with KIAG 10-32 neg. Connector Type 1983AD...



Please refer to data sheet 1631C_000-346 for further information on the cables.

<p>Sensor Type 93x1B</p> 	<p>Connecting cable Type 1631C...</p> 	<p>maXYmos Type 5867B ...</p> 
<p>Sensor Type 93x1B</p> 	<p>Connecting cable Type 1631C...</p> 	<p>Charge amplifier Type 5015A...</p> 
<p>Sensor Type 93x1B</p> 	<p>Connecting cable Type 1983AD</p> 	<p>Charge amplifier Type 5073A111</p> 

Optional Accessories

- Distributing cap
- Flange
- Connecting and extension cables:
Data sheet 'Cables for force and torque sensors' (1631C_000-346)

Type
9500A...
9501A...

Ordering Key

Quartz Force Link

Range ±2,5 kN	0
Range ±5 kN	1
Range ±10 kN	2
Range ±20 kN	3
Range ±30 kN	4
Range ±40 kN	5
Range ±60 kN	6
Range ±120 kN	7

Type 93 1B



Viton® is a registered Trademark of DuPont Performance Elastomers.