

UV - Photodetector with integrated amplifier

JIC 147 C
JIC 148 C
JIC 149 C



- characteristics :**
- ◆ integrated UV-C filter
 - ◆ spectral range 210 ... 280 nm
 - ◆ active area 0,22 mm²
 - ◆ responsivity, decadic staggering 0,8/8/80 mV/nW
 - ◆ extra sensor pin for external adjustment of gain and bandwidth
 - ◆ single supply voltage
 - ◆ sensor assembly isolated to ground
 - ◆ hermetically welded TO5-metal/glass package
 - ◆ components are in conformity with RoHS and WEEE

- applications :**
- ◆ selective UV-measurement
 - ◆ control of sterilization lamps
 - ◆ flamedetection and flamecontrol
 - ◆ control of irradiancy in varnish and adhesive hardening

absolute maximum ratings:

supply voltage	+5,5	V
working temperature range	-25 °C ... +85	°C
storage temperature range	-40 °C ... +100	°C
welding temperature (5s)	300	°C

technical data :

common test conditions, as not otherwise specified: $T_A = 25\text{ °C}$, $V_S = +5\text{ V}$
typ. values, maximum values in brackets

parameter	test condition	JIC147C	JIC148C	JIC149C	unit
feedback resistor		10	100	1.000	MΩ
dark offset voltage	$E = 0\text{ lx}$	± 1	± 2	± 3	mV
noise voltage	$B = 1\text{ kHz}$	1			mV _{rms}
max. spectral responsivity	$\lambda = 254\text{ nm}$	0,6	6	60	mV/nW
risetime		30	150	600	μs
bandwidth	- 3 dB	10	2	0,5	kHz
saturation voltage	$R_L = 2\text{ k}\Omega$	+ 4,95 (+ 4,8)			V
short current		± 50			mA
supply voltage		+ 2,7...+ 5			V
current consumption		750 (1100)			μA

rev. 2 (03/2009)

JIC 147 C, 148 C, 149 C

relative spectral responsivity

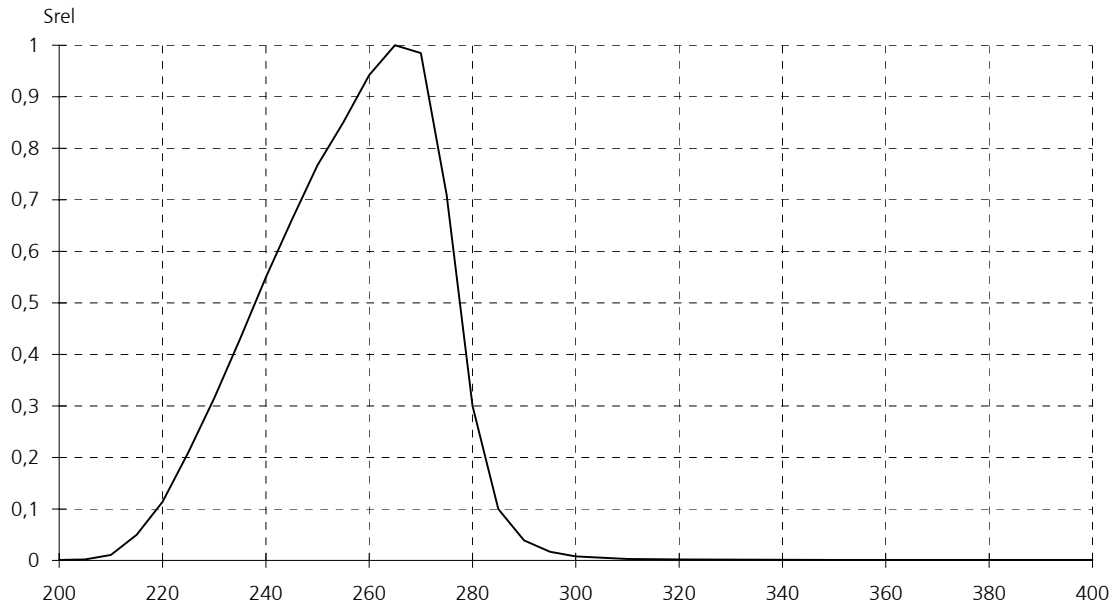

pin configuration

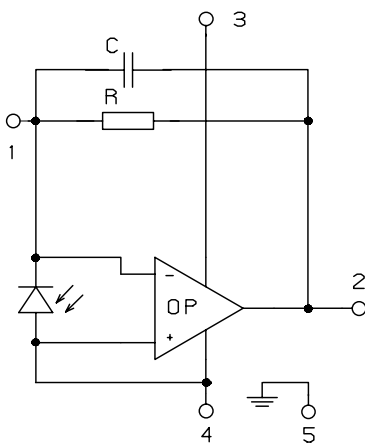

- 1 R_f
- 2 Out
- 3 V_s
- 4 GND
- 5 Case

package dimension

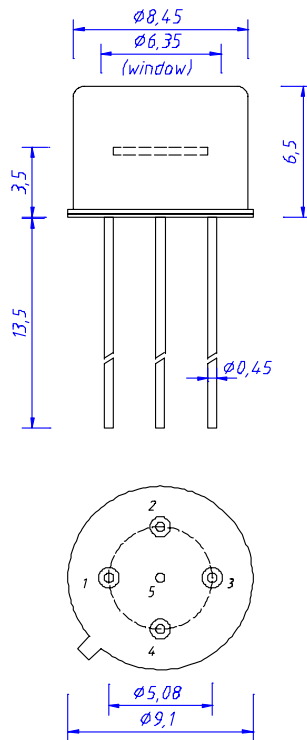

application hints:

- If an external resistor for reduction of gain is used, please make sure that length of connectors is as short as possible to reduce noise and capacitive interference.
- If internally adjusted gain is used only, please cut pin „1“.