

Typical Applications

The HMC260LC3B is ideal for:

- Point-to-Point Radios
- Point-to-Mult-Point Radios & VSAT
- Test Equipment & Sensors
- Military End-Use

Features

- Passive: No DC Bias Required
- Input IP3: +20 dBm
- LO/RF Isolation: 40 dB
- Wide IF Bandwidth: DC - 8 GHz
- 12 Lead Ceramic 3x3 mm SMT Package: 9mm²

Functional Diagram

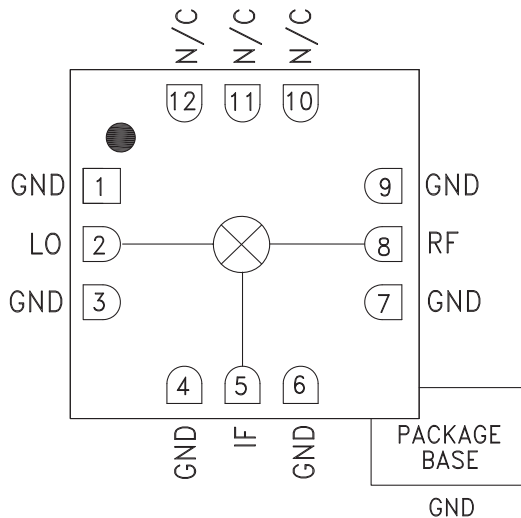

General Description

The HMC260LC3B is a general purpose double balanced mixer in a leadless RoHS compliant SMT package that can be used as an upconverter or downconverter between 14 and 26 GHz. This mixer requires no external components or matching circuitry. The HMC260LC3B provides excellent LO to RF and LO to IF suppression due to optimized balun structures. The mixer operates with LO drive levels above +9 dBm. The HMC260LC3B eliminates the need for wire bonding, allowing use of surface mount manufacturing techniques.

Electrical Specifications, $T_A = +25^\circ C$, $IF = 1 GHz$, $LO = +13 dBm^*$

| Parameter | Min. | Typ. | Max. | Min. | Typ. | Max. | Units |
|-------------------------------|------|---------|------|------|---------|------|-------|
| Frequency Range, RF & LO | | 14 - 18 | | | 18 - 26 | | GHz |
| Frequency Range, IF | | DC - 8 | | | DC - 8 | | GHz |
| Conversion Loss | | 7.5 | 10.5 | | 9 | 12 | dB |
| Noise Figure (SSB) | | 7.5 | 10.5 | | 9 | 12 | dB |
| LO to RF Isolation | 34 | 40 | | 30 | 35 | | dB |
| LO to IF Isolation | 24 | 30 | | 24 | 35 | | dB |
| RF to IF Isolation | 15 | 25 | | 25 | 30 | | dB |
| IP3 (Input) | | 18 | | | 20 | | dBm |
| IP2 (Input) | | 50 | | | 50 | | dBm |
| 1 dB Gain Compression (Input) | | 12 | | | 14 | | dBm |

*Unless otherwise noted, all measurements performed as downconverter, $IF = 1 GHz$.



HMC260LC3B

GaAs MMIC FUNDAMENTAL MIXER, 14 - 26 GHz

Conversion Gain vs. Temperature

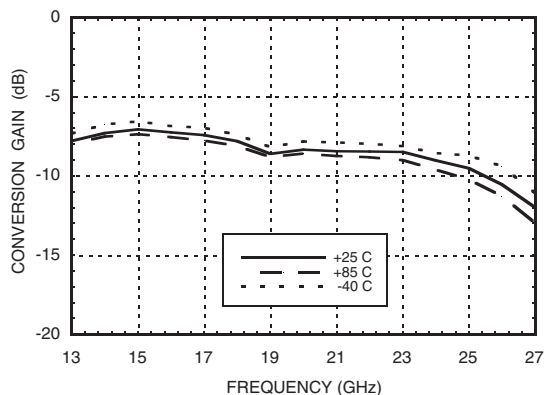

Isolation

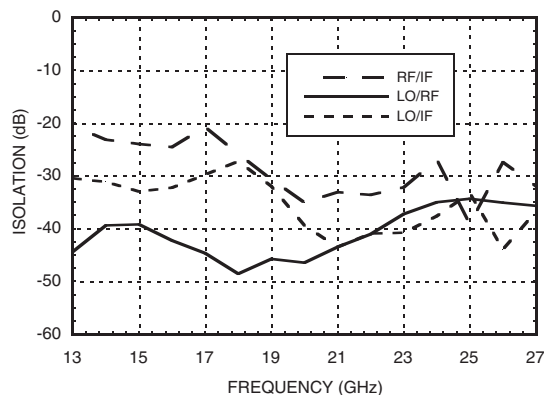

Conversion Gain vs. LO Drive

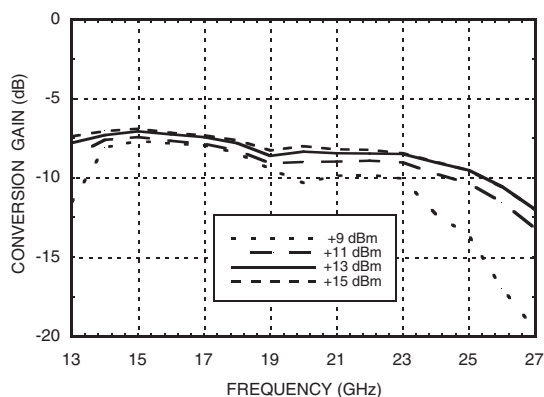

Return Loss

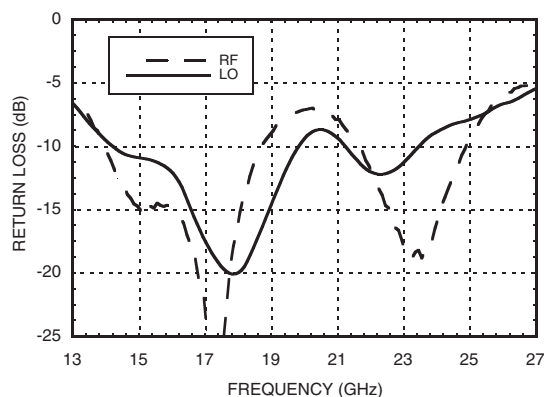

IF Bandwidth

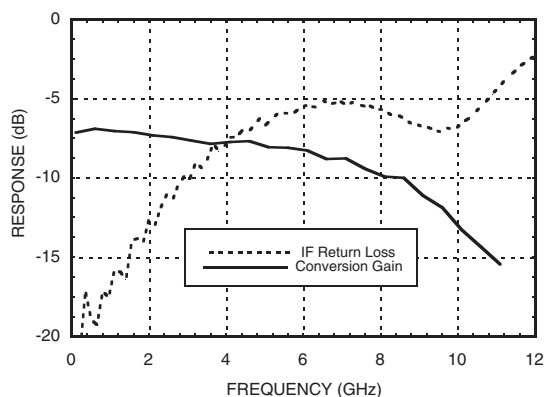

**Upconverter Performance
Conversion Gain vs. LO Drive**

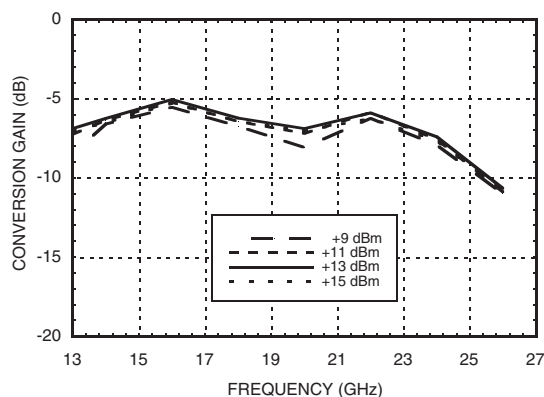



HMC260LC3B

GaAs MMIC FUNDAMENTAL MIXER, 14 - 26 GHz

9

MIXERS - SINGLE & DOUBLE BALANCED - SMT

Input IP3 vs. LO Drive *

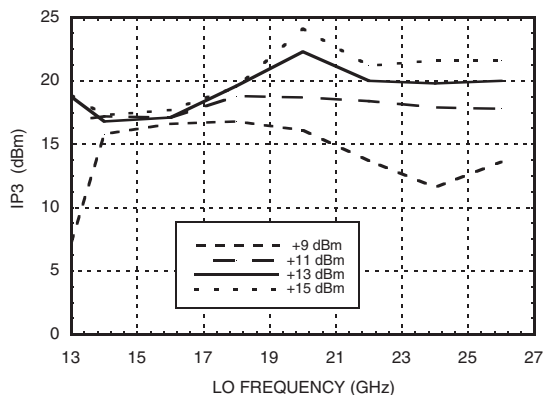

Input IP3 vs. Temperature *

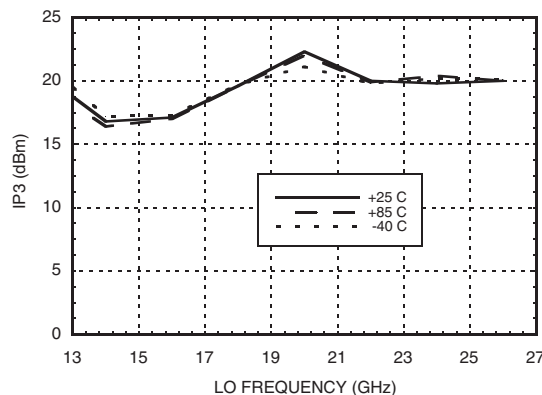

Input IP2 vs. LO Drive *

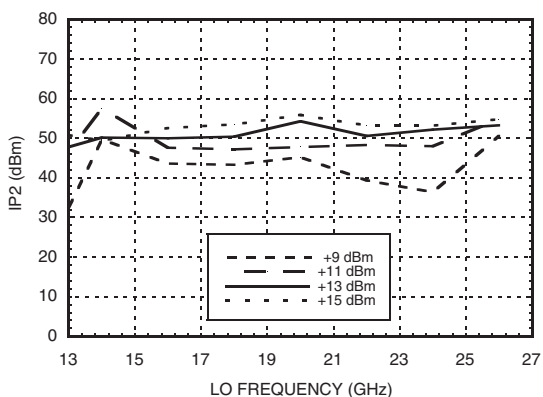

Input IP2 vs. Temperature *

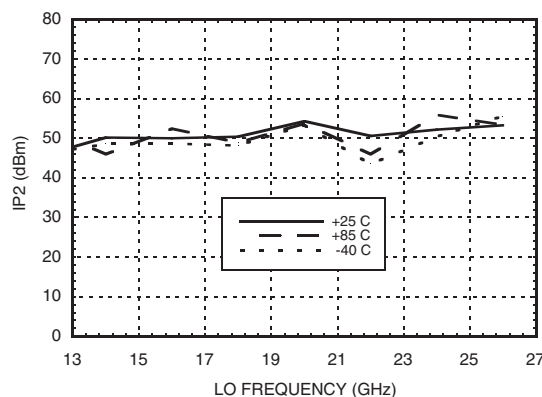

Input P1dB vs. Temperature

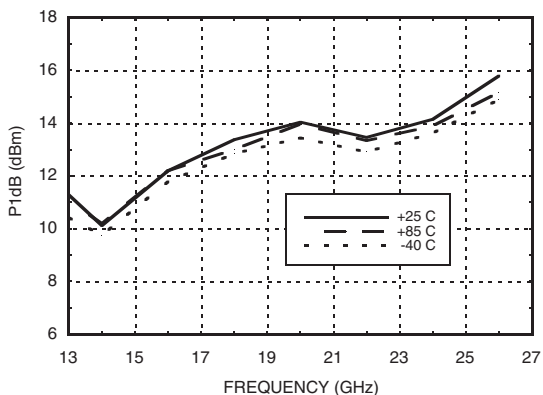

MxN Spurious Outputs

| | nLO | | | | |
|-----|-----|----|----|----|-----|
| mRF | 0 | 1 | 2 | 3 | 4 |
| 0 | xx | -2 | 17 | xx | xx |
| 1 | 18 | 0 | 38 | 50 | 78 |
| 2 | 82 | 74 | 71 | 65 | 84 |
| 3 | xx | 90 | 95 | 77 | 90 |
| 4 | xx | xx | 93 | 98 | 104 |

RF = 18 GHz @ -10 dBm
 LO = 17 GHz @ +13 dBm
 All values in dBc below the IF output power level.

* Two-tone input power = -10 dBm each tone, 1 MHz spacing.



Absolute Maximum Ratings

| | |
|--|----------------|
| RF / IF Input | +15 dBm |
| LO Drive | +27 dBm |
| Channel Temperature | 150 °C |
| Continuous Pdiss (Ta = 85 °C) (derate 3.95 mW/°C above 85 °C) | 260 mW |
| Thermal Resistance (junction to ground paddle) | 253 °C/W |
| Storage Temperature | -65 to +150 °C |
| Operating Temperature | -40 to +85 °C |
| ESD Sensitivity (HBM) | Class 1A |



**ELECTROSTATIC SENSITIVE DEVICE
 OBSERVE HANDLING PRECAUTIONS**

Outline Drawing

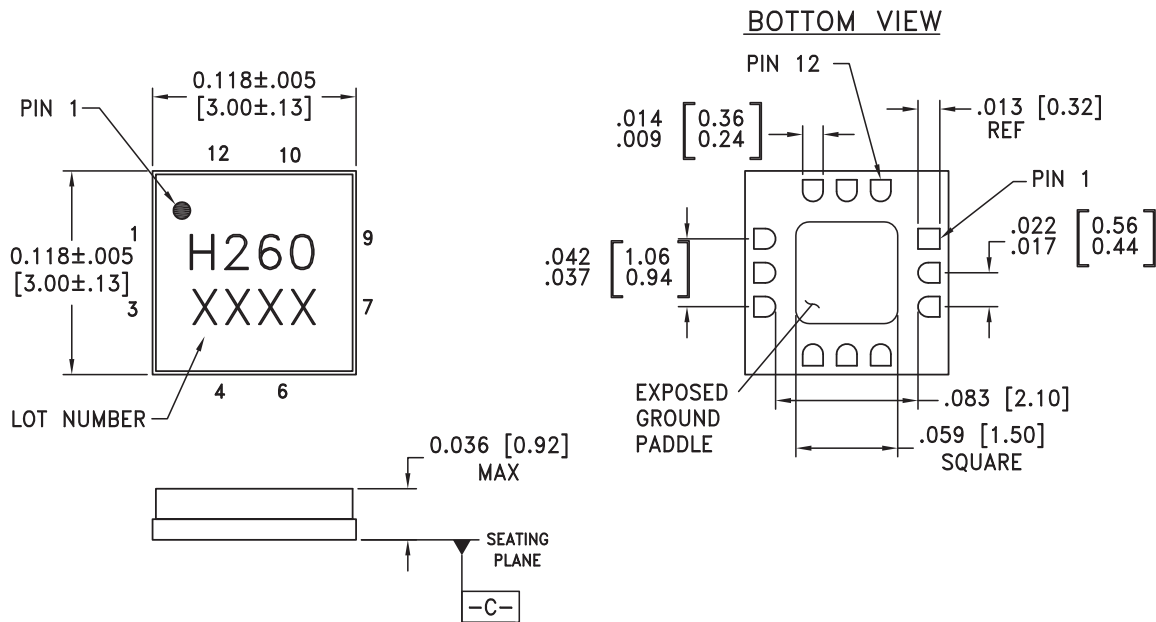

- NOTES:
1. PACKAGE BODY MATERIAL: ALUMINA.
 2. LEAD AND GROUND PADDLE PLATING: GOLD FLASH OVER NICKEL.
 3. DIMENSIONS ARE IN INCHES (MILLIMETERS).
 4. LEAD SPACING TOLERANCE IS NON-CUMULATIVE.
 5. CHARACTERS TO BE HELVETICA MEDIUM, .025 HIGH, BLACK INK, OR LASER MARK LOCATED APPROX. AS SHOWN.
 6. PACKAGE WARP SHALL NOT EXCEED 0.05MM DATUM - C -
 7. ALL GROUND LEADS AND GROUND PADDLE MUST BE SOLDERED TO PCB RF GROUND.
 8. CLASSIFIED AS MOISTURE SENSITIVITY LEVEL (MSL) 1.



Pin Descriptions

| Pin Number | Function | Description | Interface Schematic |
|------------------|----------|--|---------------------|
| 1, 3, 4, 6, 7, 9 | GND | Package bottom must also be connected to RF/DC ground. | |
| 2 | LO | This pin is DC coupled and matched to 50 Ohm. | |
| 5 | IF | This pin is DC coupled. For applications not requiring operation to DC, this port should be DC blocked externally using a series capacitor whose value has been chosen to pass the necessary IF frequency range. For operation to DC, this pin must not source or sink more than 2 mA of current or part non-function and possible part failure will result. | |
| 8 | RF | This pin is DC coupled and matched to 50 Ohm. | |
| 10, 11, 12 | N/C | No connection required. These pins may be connected to RF/DC ground without affecting performance. | |

Evaluation PCB

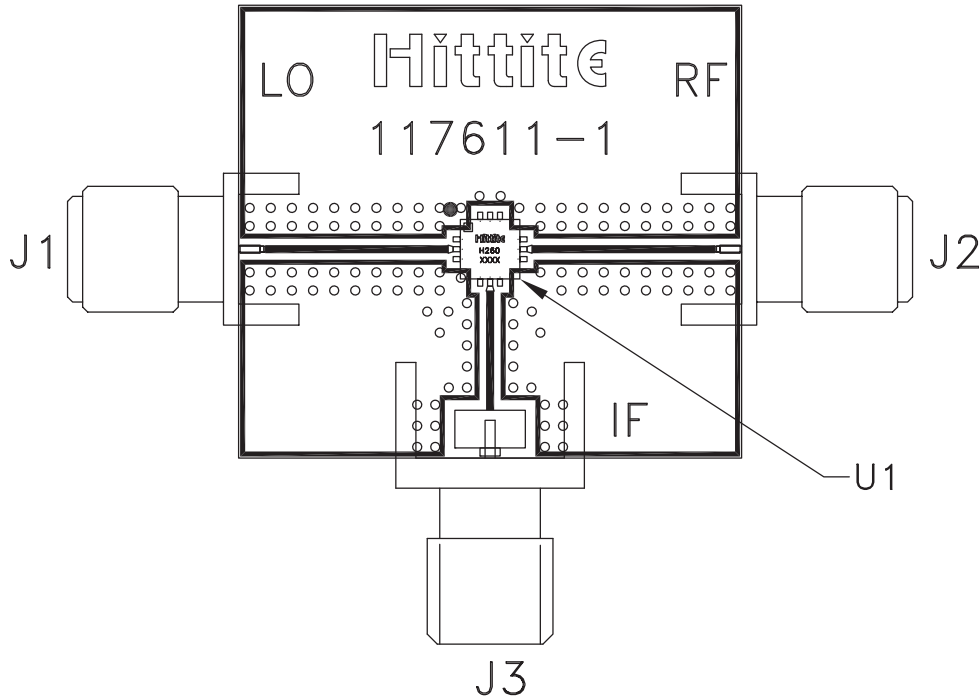

List of Materials for Evaluation PCB 109952 [1]

| Item | Description |
|---------|-----------------------|
| J1 - J2 | SRI SMA Connector |
| J3 | Johnson SMA Connector |
| U1 | HMC260LC3B Mixer |
| PCB [2] | 117611 Evaluation PCB |

[1] Reference this number when ordering complete evaluation PCB

[2] Circuit Board Material: Arlon 25 RF

The circuit board used in this application should use RF circuit design techniques. Signal lines should have 50 ohm impedance while the package ground leads and exposed paddle should be connected directly to the ground plane similar to that shown. A sufficient number of via holes should be used to connect the top and bottom ground planes. The evaluation board should be mounted to an appropriate heat sink. The evaluation circuit board shown is available from Hittite upon request.