



Typical Applications

The HMC548LP3 / HMC548LP3E is ideal for:

- Automotive Telematics
- GPS Antenna Modules / Boosters
- Location Based Portables
- Satellite Navigation

Features

- Single Supply: Vcc = +5V
- Low Noise Figure: 1.3 dB
- High Output IP3: +21 dBm
- No External Matching Required
- External Filter Access
- 3x3 mm Leadless SMT Package

Functional Diagram

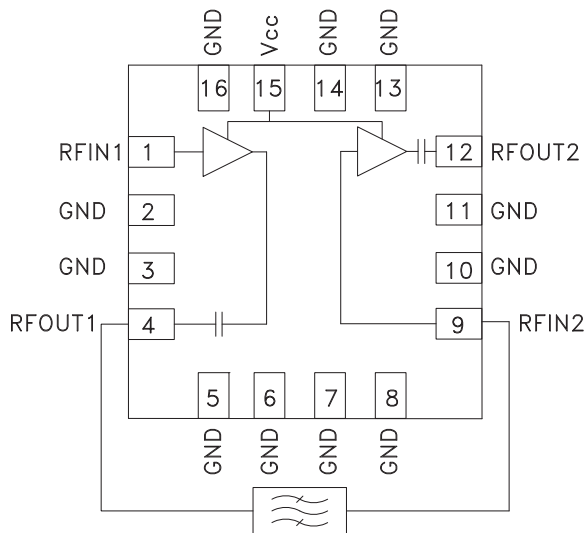

General Description

The HMC548LP3 & HMC548LP3E are comprised of two internally matched SiGe HBT MMIC low noise amplifier stages housed in 3x3 mm leadless SMT packages. The unique topology of the HMC548LP3 & HMC548LP3E provides interstage access allowing the designer to place a bandpass filter between the two amplifier stages. This filtering approach enables the receiver to reject nearby blocking signals such as those emitted from cellular and 3G hand-helds, without incurring the noise figure degradation associated with a high rejection pre-filter. When combined with the appropriate interstage bandpass filter, this LNA can be used as a receiver pre-amplifier in various applications from 1.2 to 3 GHz. Evaluation boards are available with or without a GPS L1 (1575 MHz) band pass filter.

Electrical Specifications, $T_A = +25^\circ C$, Vcc= +5V*

Parameter	Min.	Typ.	Max.	Units
Frequency Range	1575			MHz
Gain	23	26		dB
Gain Variation Over Temperature		0.04	0.05	dB/°C
Noise Figure		1.3	1.6	dB
Input Return Loss		8		dB
Output Return Loss		22		dB
Output 1 dB Compression (P1dB)		11.5		dBm
Saturated Output Power (Psat)		12.5		dBm
Output Third Order Intercept (IP3)		21		dBm
Supply Current (Icc) (Vcc = +5V)		21	30	mA

* All measurements include external 1.57 - 1.6 GHz (GPS L1) band pass filter connected between pin 4 & pin 9.



HMC548LP3 / 548LP3E

SiGe HBT MMIC LOW NOISE AMPLIFIER, 1.2 - 3.0 GHz

Gain & Return Loss [1]

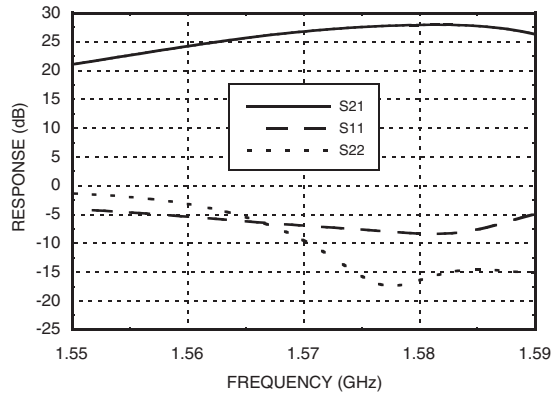

Gain vs. Temperature [1]

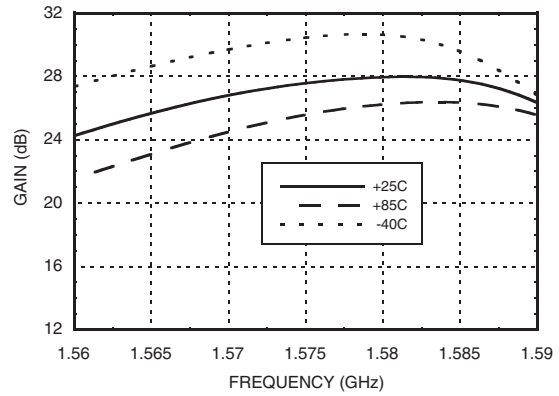

Input Return Loss vs. Temperature [1]

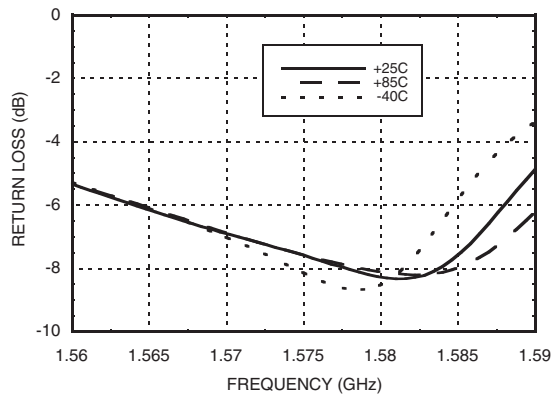

Output Return Loss vs. Temperature [1]

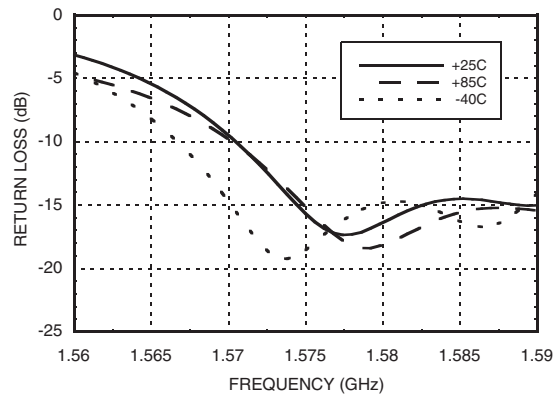

Reverse Isolation vs. Temperature [1]

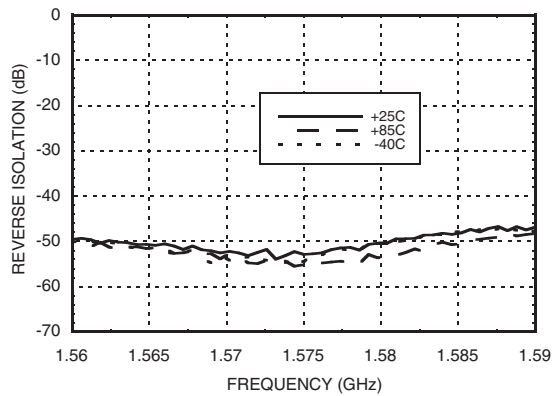

Noise Figure vs. Temperature [1]

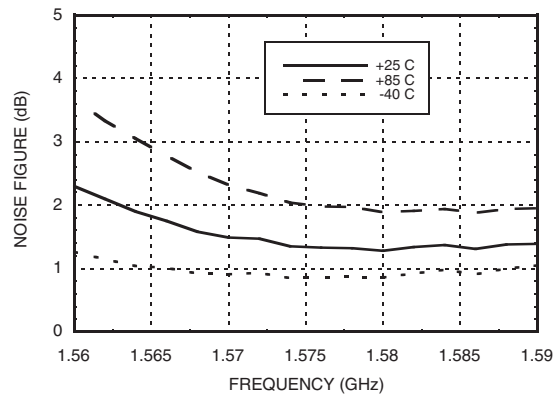

[1] Measurement includes external 1.57 - 1.6 GHz (GPS L1) band pass filter connected between pin 4 and pin 9.

[2] Measurement includes external 50 Ohm line between pin 4 and pin 9.



HMC548LP3 / 548LP3E

SiGe HBT MMIC LOW NOISE AMPLIFIER, 1.2 - 3.0 GHz

4

LOW NOISE AMPLIFIERS - SMT

P1dB vs. Temperature [1]

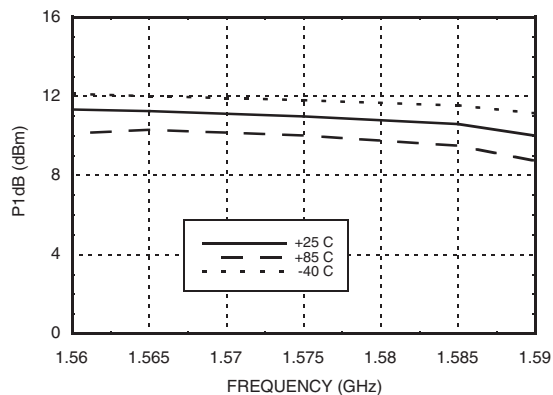

Psat vs. Temperature [1]

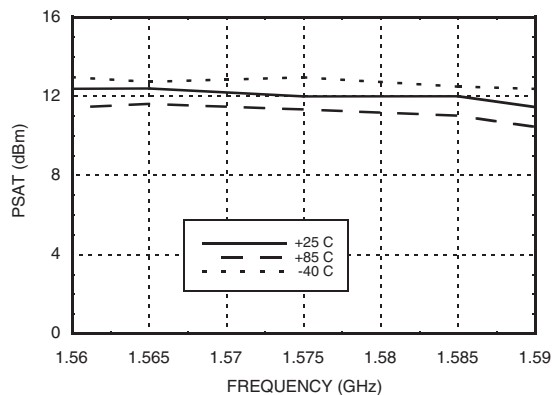

Output IP3 vs. Temperature [1]

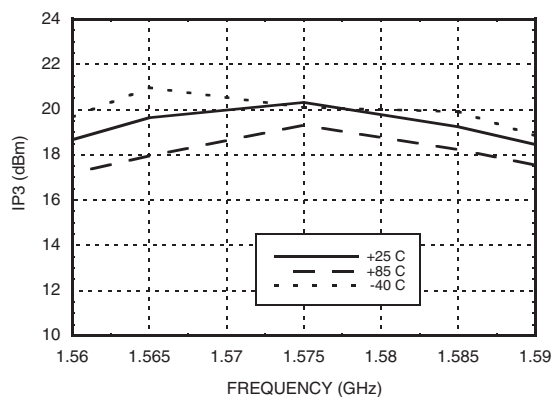

Broadband Gain & Return Loss [2]

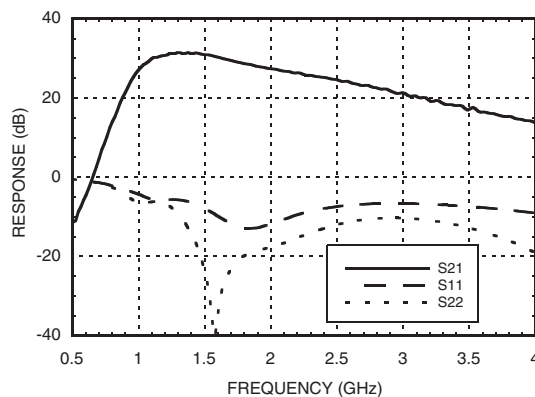

Gain vs. Temperature [2]

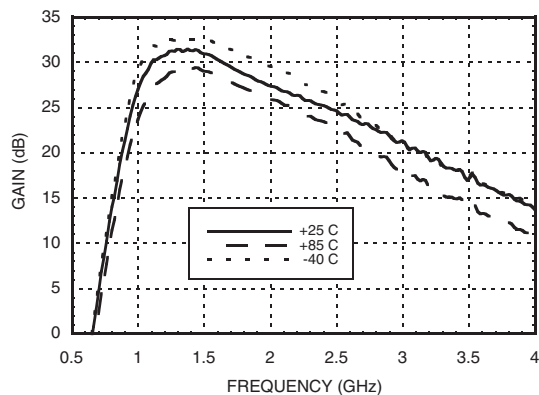

Input Return Loss vs. Temperature [2]

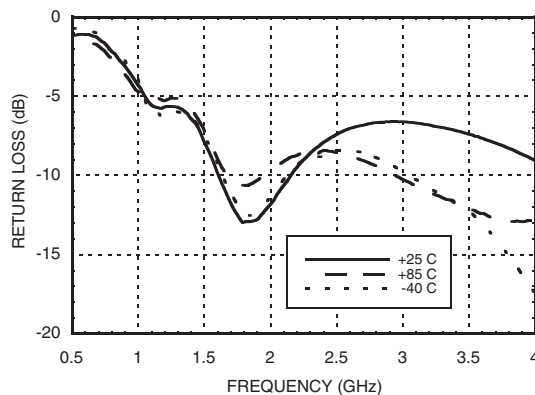

[1] Measurement includes external 1.57 - 1.6 GHz (GPS L1) band pass filter connected between pin 4 and pin 9.

[2] Measurement includes external 50 Ohm line between pin 4 and pin 9.



Output Return Loss vs. Temperature [2]

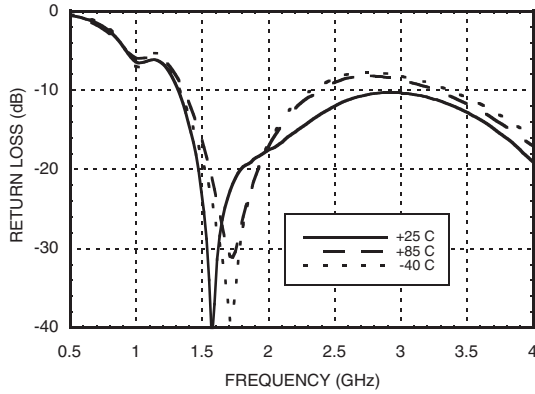

Reverse Isolation vs. Temperature [2]

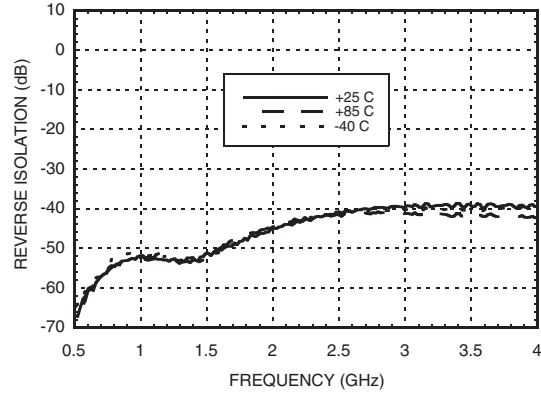

Noise Figure vs. Temperature [2]

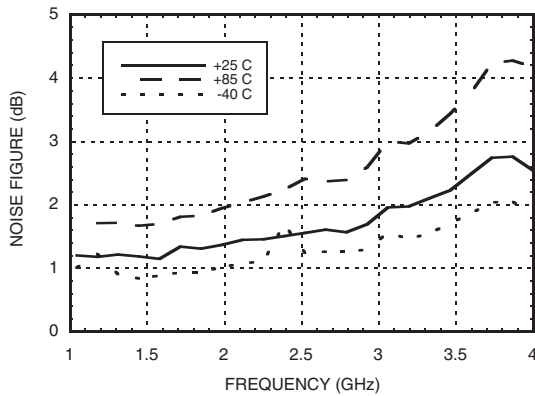

P1dB vs. Temperature [2]

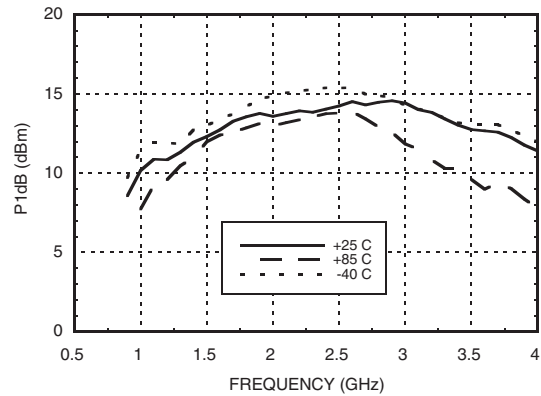

Psat vs. Temperature [2]

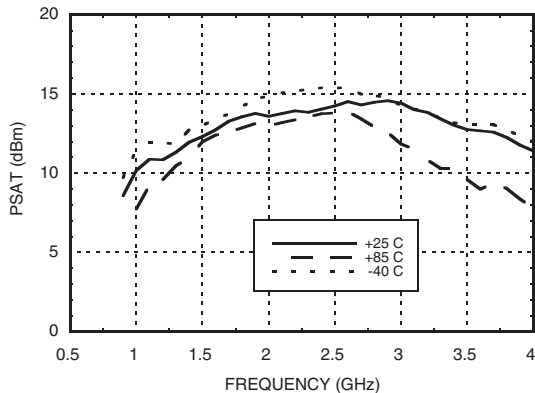

Output IP3 vs. Temperature [2]

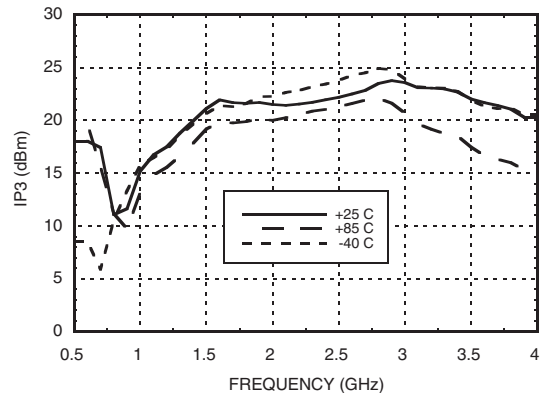

[1] Measurement includes external 1.57 - 1.6 GHz (GPS L1) band pass filter connected between pin 4 and pin 9.

[2] Measurement includes external 50 Ohm line between pin 4 and pin 9.



HMC548LP3 / 548LP3E

SiGe HBT MMIC LOW NOISE AMPLIFIER, 1.2 - 3.0 GHz

4

LOW NOISE AMPLIFIERS - SMT

Small Signal Parameters Input Stage

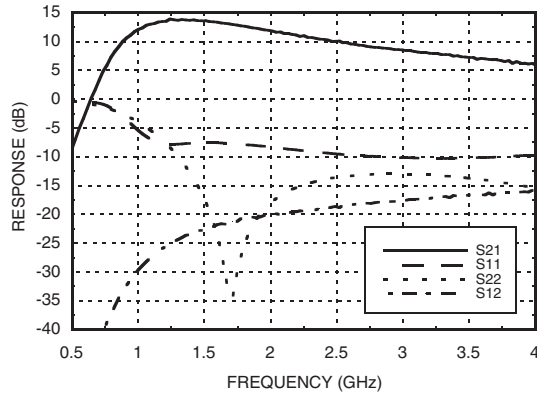

Small Signal Parameters Output Stage

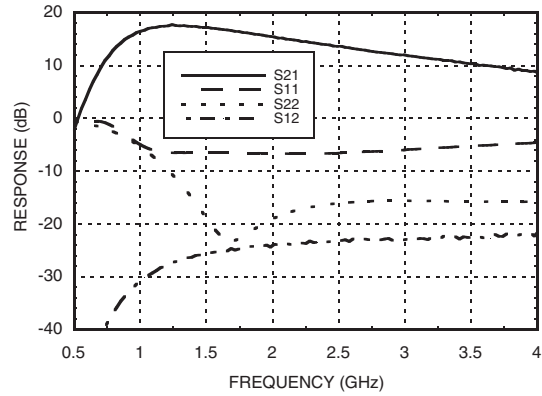

P1dB Individual Stages

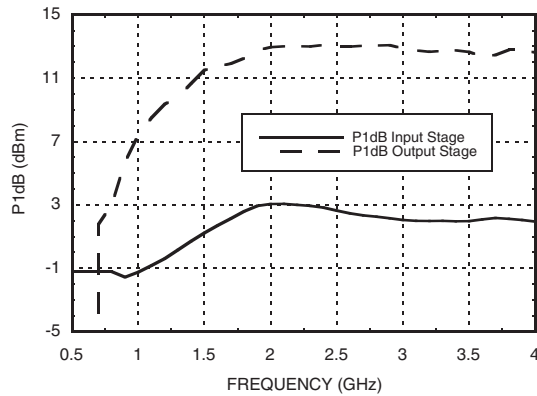

Noise Figure Individual Stages

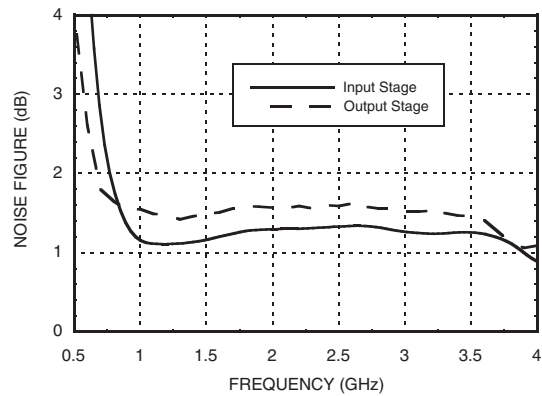

Typical Supply Current vs. Vcc

Vcc (Vdc)	Icc (mA)
4.5	17
5.0	21
5.5	24



HMC548LP3 / 548LP3E

SiGe HBT MMIC LOW NOISE AMPLIFIER, 1.2 - 3.0 GHz

Absolute Maximum Ratings

Drain Bias Voltage (Vcc)	+7.0 Vdc
RF Input Power (RFIN)(Vcc = +5.0 Vdc)	-5 dBm
Junction Temperature	150 °C
Continuous P _{diss} (T = 85 °C) (derate 14 mW/°C above 85 °C)	0.942 W
Thermal Resistance (junction to ground paddle)	69 °C/W
Storage Temperature	-65 to +150 °C
Operating Temperature	-40 to +85 °C
ESD Sensitivity (HBM)	Class 1B



ELECTROSTATIC SENSITIVE DEVICE
OBSERVE HANDLING PRECAUTIONS

Outline Drawing

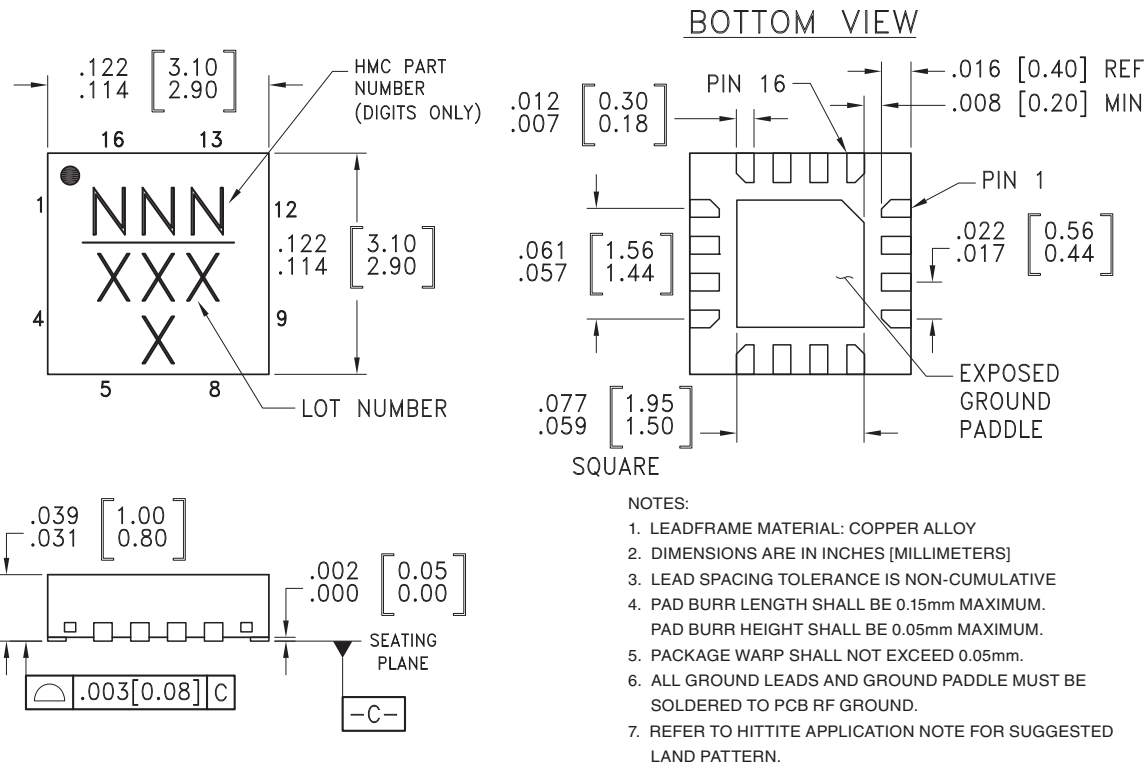

Package Information

Part Number	Package Body Material	Lead Finish	MSL Rating	Package Marking ^[3]
HMC548LP3	Low Stress Injection Molded Plastic	Sn/Pb Solder	MSL1 ^[1]	548 XXXX
HMC548LP3E	RoHS-compliant Low Stress Injection Molded Plastic	100% matte Sn	MSL1 ^[2]	548 XXXX

[1] Max peak reflow temperature of 235 °C
 [2] Max peak reflow temperature of 260 °C
 [3] 4-Digit lot number XXXX



Pin Descriptions

Pin Number	Function	Description	Interface Schematic
1	RFIN1	This pin is DC coupled and matched to 50 Ohms from 1.2 to 2.0 GHz. An off chip blocking capacitor is required.	
2, 3, 5-8, 10, 11, 13, 14, 16	GND	These pins and package ground paddle must be connected to RF/DC ground.	
4	RFOUT1	This pin is AC coupled and matched to 50 Ohms from 1.2 - 2 GHz.	
9	RFIN2	This pin is DC coupled and matched to 50 Ohms from 1.2 to 2.0 GHz. An off chip blocking capacitor is required.	
12	RFOUT2	This pin is AC coupled and matched to 50 Ohms from 1.2 - 2 GHz.	
15	Vcc	Power supply voltage for the amplifier. External bypass capacitors of 1,000pF and 18,000 pF are required.	

Application Circuit

Component	Value
C1, C2	150 pF
C3	1,000 pF
C4	18,000 pF

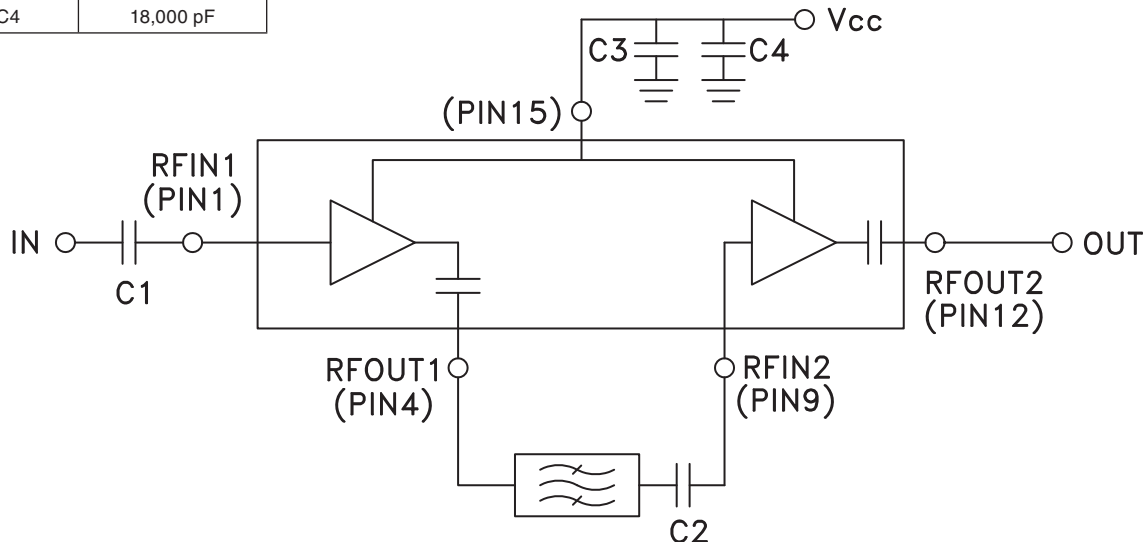

1575 MHz Evaluation PCB

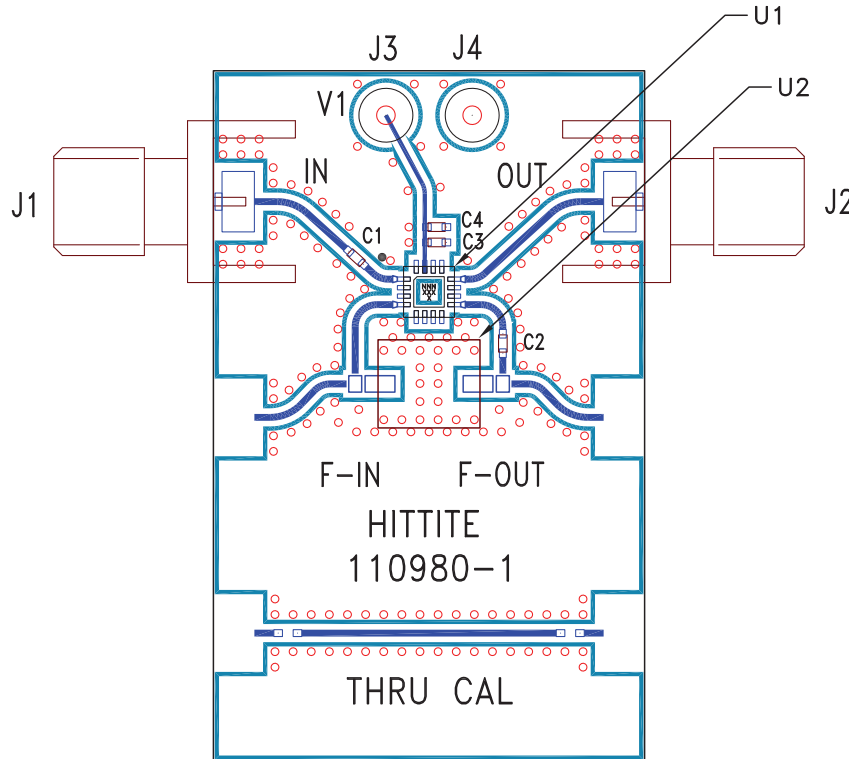

List of Material for Evaluation PCB 114254^[1]

Item	Description
J1, J2	PCB Mount SMA Connector
J3, J4	DC Pin
C1, C2	150 pF Capacitor, 0402 Pkg.
C3	1000 pF Capacitor, 0402 Pkg.
C4	18,000 pF Capacitor, 0402 Pkg.
U1	HMC548LP3 / HMC548LP3E Amplifier
U2	Filter, Amotech AMOBP1575P02-A1 2.5 dB loss @ 1575 MHz
PCB [2]	110980 Eval Board

[1] Reference this number when ordering complete evaluation PCB

[2] Circuit Board Material: Roger 4350

The circuit board used in the final application should use RF circuit design techniques. Signal lines should have 50 ohm impedance while the package ground leads and exposed ground paddle should be connected directly to the ground plane similar to that shown above. A sufficient number of via holes should be used to connect the top and bottom ground planes. The evaluation circuit board shown is available from Hittite upon request.



Wideband (No Filter) Evaluation PCB

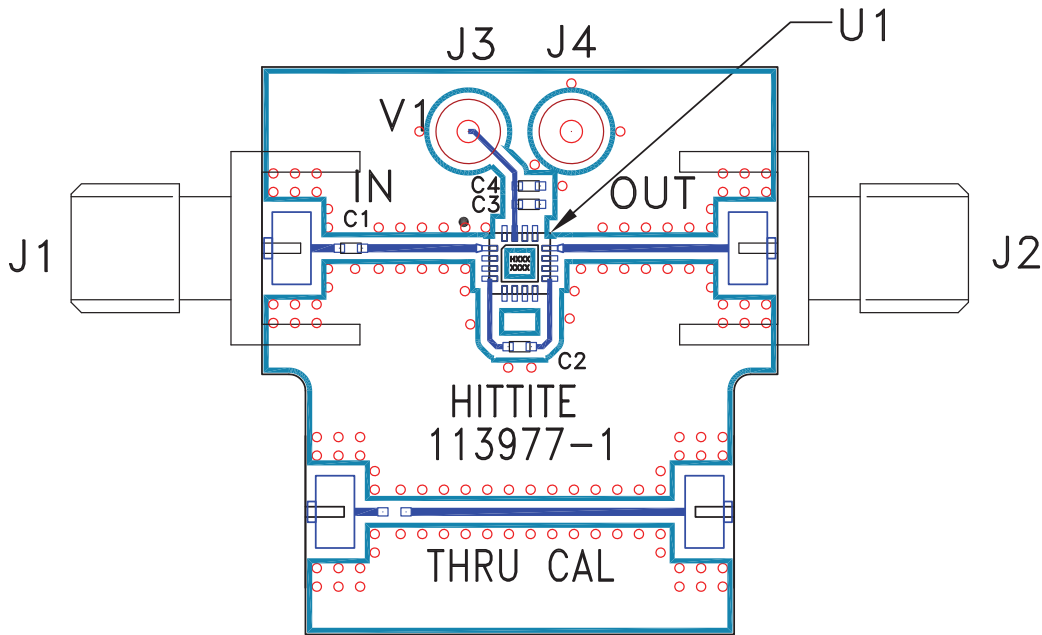

List of Material for Evaluation PCB 113979 [1]

Item	Description
J1, J2	PCB Mount SMA Connector
J3, J4	DC Pin
C1, C2	150 pF Capacitor, 0402 Pkg.
C3	1000 pF Capacitor, 0402 Pkg.
C4	18,000 pF Capacitor, 0402 Pkg.
U1	HMC548LP3 / HMC548LP3E Amplifier
PCB [2]	113977 Eval Board

The circuit board used in the final application should use RF circuit design techniques. Signal lines should have 50 ohm impedance while the package ground leads and exposed ground paddle should be connected directly to the ground plane similar to that shown above. A sufficient number of via holes should be used to connect the top and bottom ground planes. The evaluation circuit board shown is available from Hittite upon request.

[1] Reference this number when ordering complete evaluation PCB

[2] Circuit Board Material: Roger 4350



Notes: