

Printer / Copy Machine

① NC Sensor

Non Contact

Zero Power Resistance: $R_{180} = 7k\Omega \pm 5\%$
 B value : $B_{25/85} = 3370K \pm 1\%$
 Temperature range $\times 1$: $-10^{\circ}C - 150^{\circ}C$
 Measurement temp. range : $-10^{\circ}C - 260^{\circ}C$

Features: A non contact Sensor based on infrared detection that has very strong heat and dirt resistance.

Unit: mm

- ◆ Thermal Time Constant: approx. 1.3 sec.
- ◆ Dielectric Strength Voltage: AC 500V 1 sec.
- ◆ Insulation Resistance: DC500V 100M Ω +

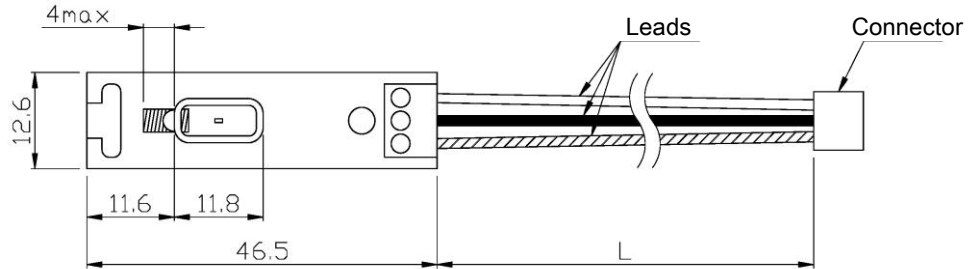

※1: Without connector

② Thermopile Module

Non Contact

Source Voltage : 3.2V - 6V
 Output Voltage : 0.2V - 2.8V
 Temperature range : $-25^{\circ}C - 100^{\circ}C$
 Measurement temp. range : $-20^{\circ}C - 250^{\circ}C$

Features: A non contact Sensor based on infrared detection that measures temperature easily and accurately.

Unit: mm

- ◆ Thermal Time Constant: approx. 46ms

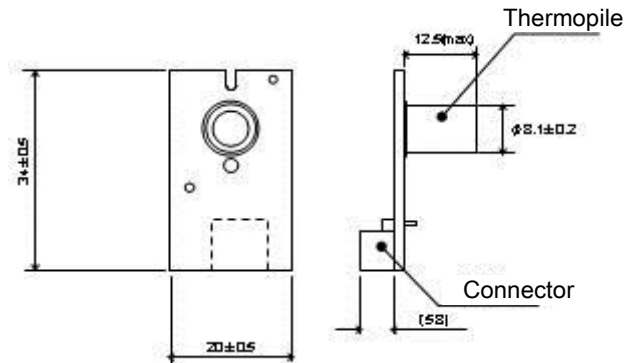
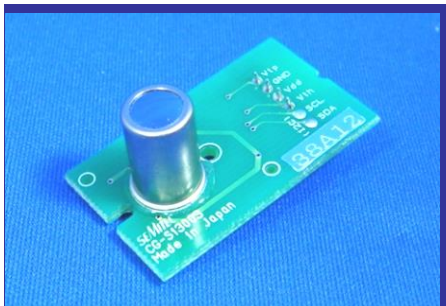

③ HF-N Sensor

Non Contact

Zero Power Resistance : $R_{180} = 7k\Omega \pm 5\%$
 B value : $B_{25/85} = 3370K \pm 3\%$
 Temperature range : $-20^{\circ}C - 230^{\circ}C$ (Sensing part)

Features: A Sensor that allows non contact measurement with conventional thermistor systems.

Unit: mm

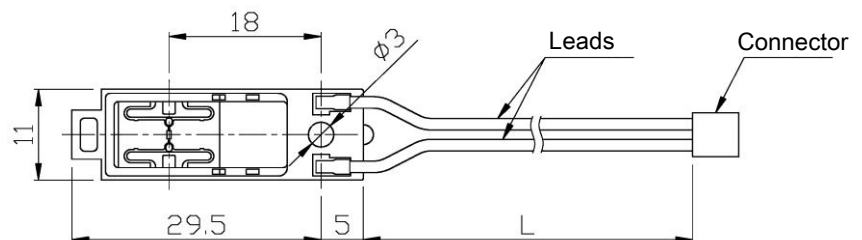
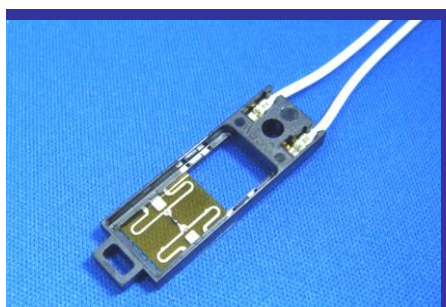

④FS Sensor

Zero Power Resistance: $R_{180} = 7k\Omega \pm 5\%$
 B value : $B_{25/85} = 3370K \pm 3\%$
 Temperature range : $-20^{\circ}C - 230^{\circ}C$ (Sensing part)

- ◆Thermal Time Constant: approx. 1.0 sec. (roller)
- ◆Dielectric Strength Voltage: AC 600V 1 sec.
- ◆Insulation Resistance: DC 500V 100M Ω +

Unit: mm

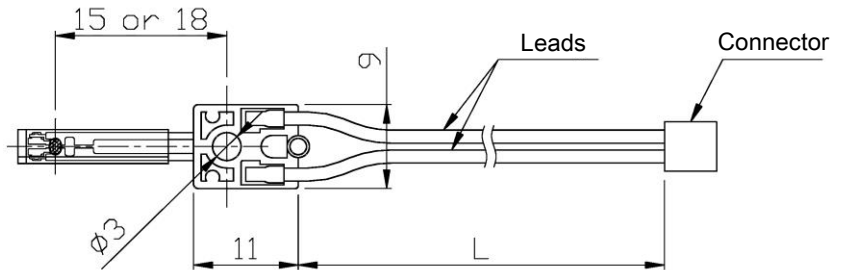
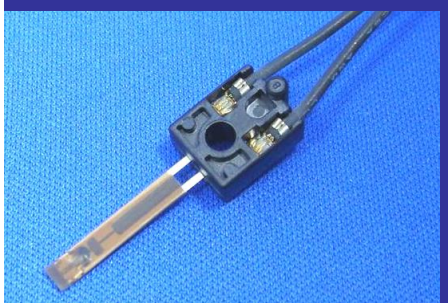

⑤HF-H Sensor

Zero Power Resistance: $R_{180} = 7k\Omega \pm 5\%$
 B value : $B_{25/85} = 3370K \pm 3\%$
 Temperature range : $-20 - 230^{\circ}C$ (Sensing part)

- ◆Thermal Time Constant: approx. 0.7 sec. (roller)
- ◆Dielectric Strength Voltage: AC600V 1 sec.
- ◆Insulation Resistance: DC 500V 100M Ω +

Unit: mm

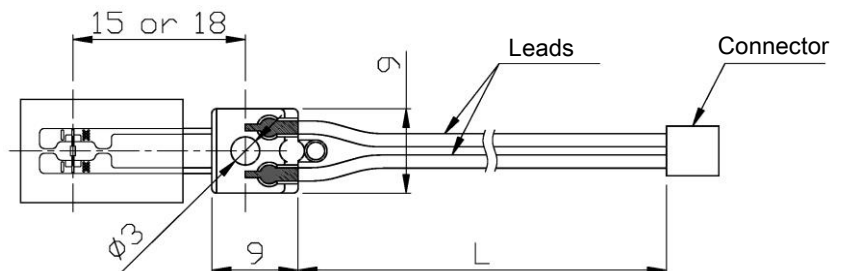
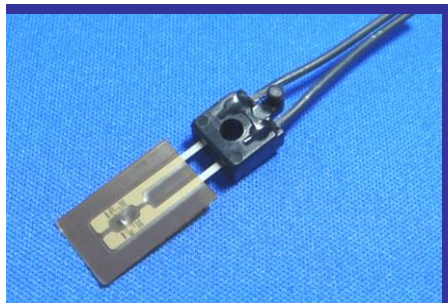

⑥HF-L Sensor

Zero Power Resistance: $R_{180} = 7k\Omega \pm 5\%$
 B value : $B_{25/85} = 3370K \pm 3\%$
 Temperature range : $-20 - 230^{\circ}C$ (Sensing part)

- ◆Thermal Time Constant: approx. 1.0 sec. (roller)
- ◆Dielectric Strength Voltage: AC600V 1 sec.
- ◆Insulation Resistance: DC 500V 100M Ω +

Unit: mm

