

LTS Q2

Pyroelectric Single Element Detector for Measurement Applications

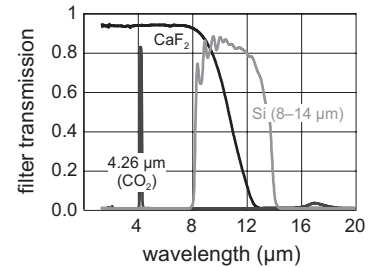
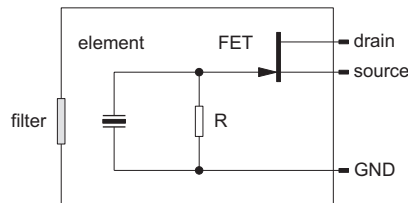
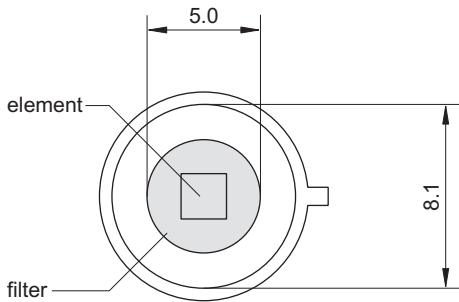
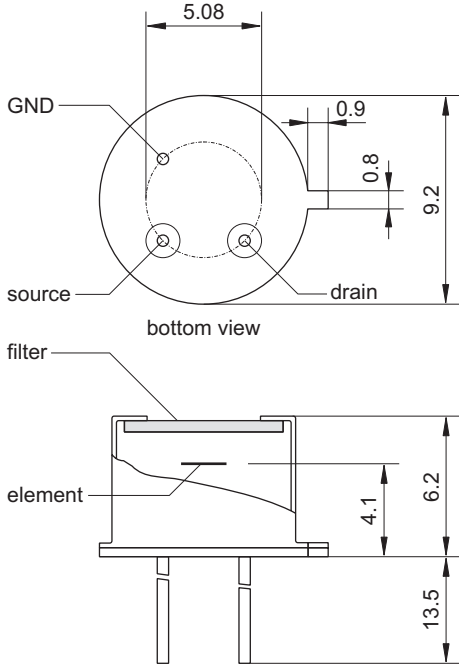

element size	2 mm × 2 mm
aperture	5.0 mm
filter ³	custom-designed
responsivity ^{1,2}	>420 V/W
noise ¹	<150 nV/√Hz
specific detectivity ^{1,2}	>5·10 ⁸ cm√Hz/W
offset voltage	0.4 to 1.5 V
operating voltage	2 to 18 V
housing	TO 39
operating temperature	-20 to 60 °C
storage temperature	-20 to 60 °C

- 1) frequency: 10 Hz, detector temperature: 25 °C
- 2) black body source temperature: 500 K, filter transmission: 100 %
- 3) other filters on request

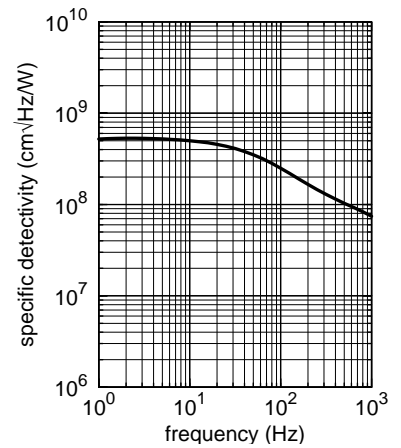
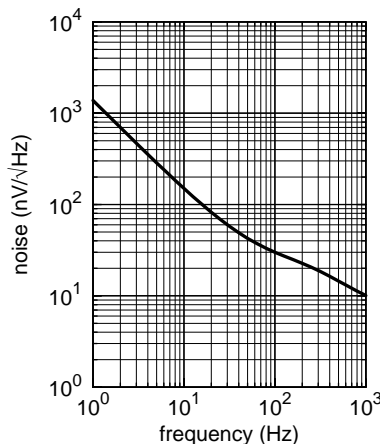
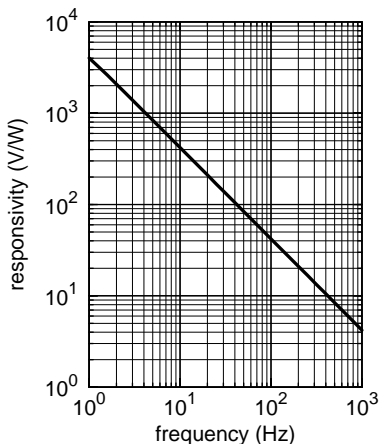

Further developments may entail modifications of indicated data without notification. Revision 05/2005. 04052005 scitec_ltsq2_eng

Scitec Instruments Ltd – Bartles Industrial Estate
 North Street, Redruth, TR15 1HR UK
 phone: +44 (0)1209 314 608 · fax: +44 (0)1209 314 609
 e-mail: sales@scitec.uk.com · www.scitec.uk.com

