

包装数量及包装形式 Packing quantity-Packing form

形式 Form	CSA20, CSA30: 数量 CSA20, CSA30 /Unit quantity	CSA70: 数量 CSA70/Unit quantity	DSA: 数量 DSA/Unit quantity	DA38: 数量 DA38/Unit quantity	DA53: 数量 DA53/Unit quantity	DB60: 数量 DB60/Unit quantity
散袋装 Bulk packing in plastic bag	B类: 500个袋 B type: 500pcs/bag	B类: 1000个袋 B type: 1000pcs/bag	A类: 100个/袋 S类: 200个/袋 A type: 100pcs/bag S type: 200pcs/bag -05F25: 100个/袋 -05F25: 100pcs/bag -U10T: 100个/袋 -U10T: 100pcs/bag	B类: 200个袋 B type: 200pcs/bag	F类: 100个/袋 F type: 100pcs/bag -E15E: 100个袋 -E25E: 100个袋 -E15E: 100pcs/bag -E25E: 100pcs/bag	
轴向编带(箱装) Axial taping(in box)				A21F: 800个/箱 A21F: 800pcs/box		
径向编带(箱装) Radial taping(in box)						1000个/袋 1000pcs/box
SMD编带(卷装) SMD taping(in reel)		T类: 2000个/卷 T type: 2000pcs/reel				

形式 Form	DSP: 数量 DSP/Unit quantity	高电压DSP: 数量 High voltage DSP/Unit quantity	DSS: 数量 DSS/Unit quantity	高电压DSS: 数量 High voltage DSS/Unit quantity	DE37: 数量 DE37/Unit quantity	DA33: 数量 DA33/Unit quantity
散袋装 Bulk packing in plastic bag			S00B类: 200个/箱 S00B: 200pcs/box			
轴向编带(箱装) Axial taping(in box)	A11F: 2000个/箱 A11F: 2000pcs/box A21F: 2000个/箱 A21F: 2000pcs/box A12F: 2000个/箱 A12F: 2000pcs/box A22F: 2000个/箱 A22F: 2000pcs/box		A21F: 1000个/箱 A21F: 1000pcs/box A12F: 1000个/箱 A12F: 1000pcs/box A22F: 1000个/箱 A22F: 1000pcs/box		A12F: 1000个/箱 A12F: 1000pcs/box A22F: 1000个/箱 A22F: 1000pcs/box	A21F: 1000个/箱 A21F: 1000pcs/box A12F: 1000个/箱 A12F: 1000pcs/box A22F: 1000个/箱 A22F: 1000pcs/box
轴向编带(卷装) Axial taping(in reel)	A21R: 4000个/卷 A21R: 4000pcs/reel A22R: 3000个/卷 A22R: 3000pcs/reel		A21R: 3000个/卷 A21R: 3000pcs/reel A22R: 3000个/卷 A22R: 3000pcs/reel			A21R: 3000个/卷 A21R: 3000pcs/reel A22R: 3000个/卷 A22R: 3000pcs/reel
径向编带(箱装) Radial taping(in box)	C04F: 2000个/箱 C04F :2000pcs/box D04F: 2000个/箱 D04F :2000pcs/box		C04F :2000个/箱 C04F :2000pcs/box D04F: 2000个/箱 D04F :2000pcs/box		D04F :2000个/箱 D04F :2000pcs/box (D37-362M除外) (C04F: 2000个/箱 C04F :2000pcs/box) (Expect: D37-362M)	C04F :2000个/箱 C04F :2000pcs/box D04F: 2000个/箱 D04F :2000pcs/box
径向编带(卷装) Radial taping(in reel)	C04R: 3000个/卷 C04R: 3000pcs/reel		C04R: 3000个/卷 C04R: 3000pcs/reel			C04R: 3000个/卷 C04R: 3000pcs/reel

散袋装 <S00B>
Bulk <S00B>

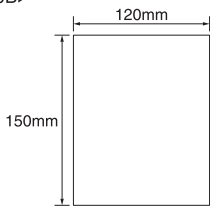

扁平包装 <A11F · A12F>
Ammo pack <A11F-A12F>

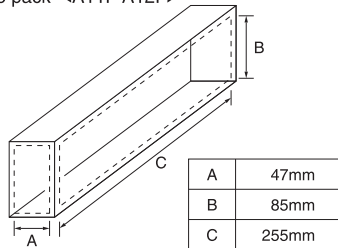

扁平包装 <C04F>
Ammo pack <C04F>

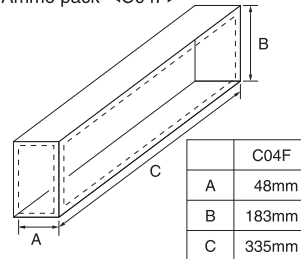

扁平包装 <DB60>
Ammo pack <DB60>

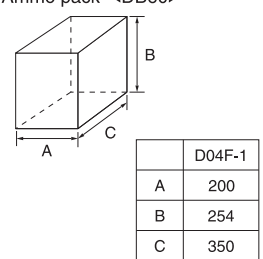

扁平包装 <A21F · A22F>
Ammo pack <A21F-A22F>

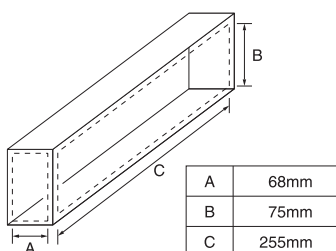

卷盘包装 <A21R · A22R>
Reel <A21R-A22R>

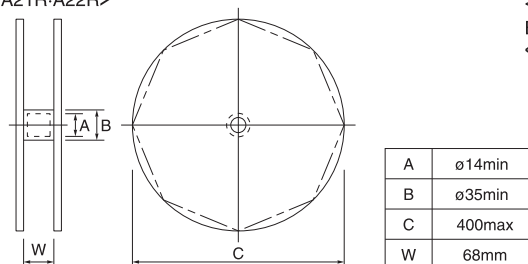

包装袋
<CSA20, CSA30, CSA70>
Bulk
<CSA20, CSA30, CSA70>

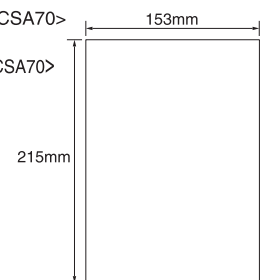

■ 编带 Taping

轴向编带 Axial taping

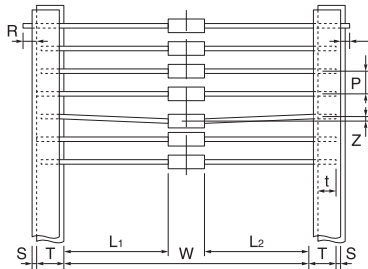

径向编带: C04F
 (※高电压DSP及高电压DSS系列无此类型。)

Radial taping:C04F
 (※High voltage DSP and high voltage DSS is not provided in this form.)

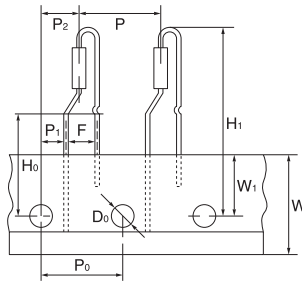

径向编带: D04F
 (※高电压DSP及高电压DSS系列无此类型。)

Radial taping:D04F
 (※High voltage DSP and high voltage DSS is not provided in this form.)

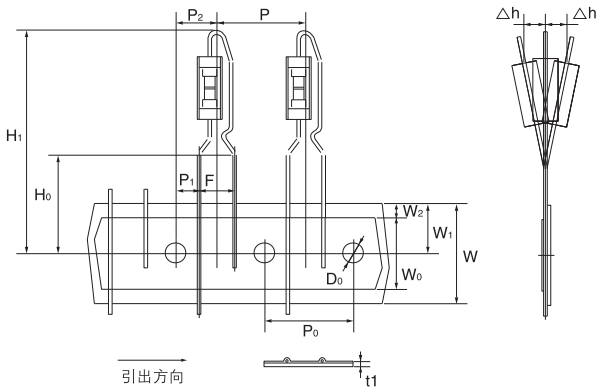

径向编带 (DB系列)

Radial taping (DB Series)

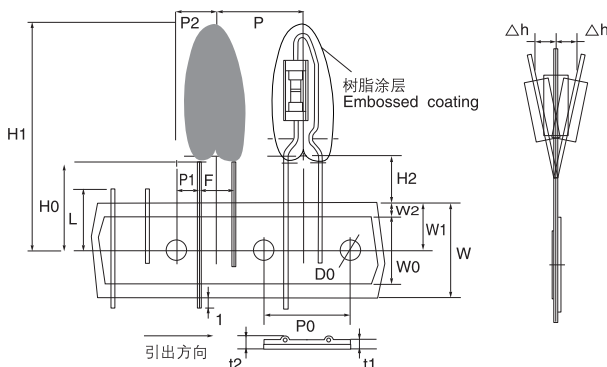

记号 Symbol	轴向编带 Axial Taping(mm)			
	A11	A21	A12	A22
W	26 +1.5 -0.0	52 +2.0 -1.0	26 +1.5 -0.0	52 +2.0 -1.0
P	5.0±0.5		10.0±0.5	
L1-L2	1以下 1max.		1以下 1max.	
T	6.0±1.0			
Z	1.0以下 1.0max.	1.2以下 1.2max.	1.0以下 1.0max.	1.2以下 1.2max.
R	端子不得露出编带。 Terminal must not project from tape.			
t	3.2以上 3.2min.			
S	0.8以下 0.8max.			

记号 Symbol	径向编带C04F Radial Taping C04F (mm)
P	12.7±1.0
P0	12.7±0.3
P1	3.85±0.5
P2	6.35±1.3
F	5.0±0.5
W	18.0 +1.0 -0.5
W1	9.0±0.5
H0	16.0±0.5
H1	32.2以下 (32.2max.)
D0	φ4.0±0.2

记号 Symbol	径向编带D04F Radial Taping D04F (mm)
P	12.7±1.0
P0	12.7±0.3
P1	3.85±0.5
P2	6.35±1.0
F	5.0±0.5
W	18.0 +1.0 -0.5
W0	13.0±0.5
W1	9.0±0.5
W2	3.0max.
H0	16.0±0.5
D0	4.0±0.2
Δh	2.0max.
H1	32.25max.
t1	0.6±0.3

单位 unit (mm)

记号 Symbol	尺寸 Dimensions	容许偏差 Tolerance	记号 Symbol	尺寸 Dimensions	容许偏差 Tolerance
P	12.7	±1.0	H0	15.0	±2.5
P0	12.7	±0.3	D0	4.0	±0.2
P1	3.85	±0.5	L	11.0	Max.
P2	6.35	±1.0	I	1.0	Max.
F	5.0	±0.5	Δh	2.0	Max.
W	18.0	+1.0 -0.5	H1	32.0	Max.
W0	13.0	±0.5	H2	3.5	Min.
W1	9.0	±0.5	t1	0.6	±0.3
W2	3.0	Max.	t2	1.5	Max.

SMD编带 (CSA20系列) SMD Taping (CSA20 Series)

包装记号 Packing code	系列 Series	包装数量 Packing Qty
T	CSA20	2,000

卷盘 Reel

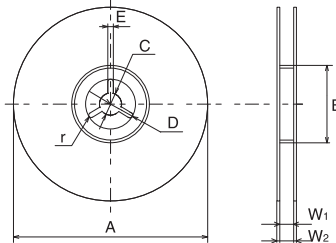

塑料卷盘 (标准型) Reel

单位 unit (mm)

A	B	C	D
$\varnothing 180.0^{+0}_{-3}$	$\varnothing 60^{+1}_{-0}$	$\varnothing 13.0 \pm 0.2$	$R10.5 \pm 0.4$
E	W_1	W_2	r
2.0 ± 0.5	9.0 ± 0.3	11.4 ± 1.0	0.5

塑料载带 Plastic carrier tape

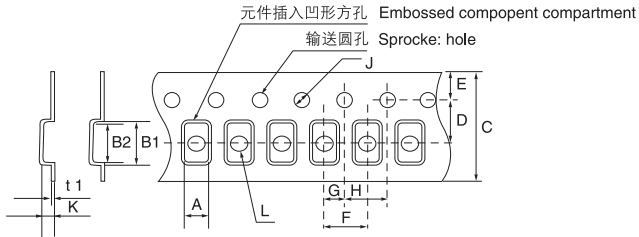

单位 unit (mm)

形状 mark	A	B	C	D	E	F
CSA20	1.45 ± 0.1	2.20 ± 0.1	8.00 ± 0.2	3.50 ± 0.05	$1.75^{+0.1}_{-0}$	4.00 ± 0.1
形状 mark	G	H	J	K	L	t1
CSA20	2.00 ± 0.05	4.0 ± 0.1	$\varnothing 1.50^{+0.1}_{-0}$	1.42 ± 0.05	$\varnothing 1.0^{+1.0}_{-0}$	0.25 ± 0.05

D,G的尺寸为每个袋子的中心值

SMD编带 (CSA30系列) SMD Taping (CSA30 Series)

包装记号 Packing code	系列 Series	包装数量 Packing Qty
T	CSA30	2,000

卷盘 Reel

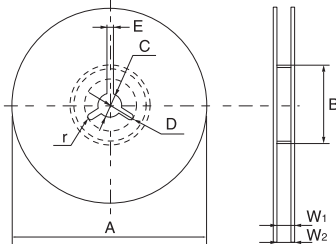

塑料卷盘 (标准型) Reel

单位 unit (mm)

A	B	C	D
$\varnothing 180.0^{+0}_{-3}$	$\varnothing 60^{+1}_{-0}$	$\varnothing 13.0 \pm 0.2$	$R10.5 \pm 0.4$
E	W_1	W_2	r
2.0 ± 0.5	9.0 ± 0.3	11.4 ± 1.0	0.5

塑料载带 Plastic carrier tape

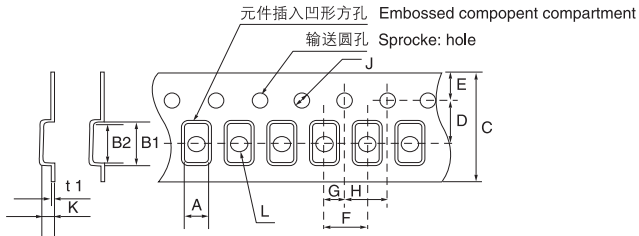

单位 unit (mm)

形状 mark	A	B	C	D	E	F
CSA30	1.85 ± 0.05	3.50 ± 0.05	8.0 ± 0.1	3.50 ± 0.05	1.75 ± 0.1	4.0 ± 0.1
形状 mark	G	H	J	K	L	t1
CSA30	2.00 ± 0.05	4.0 ± 0.1	$\varnothing 1.55 \pm 0.05$	1.80 ± 0.05	$\varnothing 1.05 \pm 0.05$	0.25以下

SMD编带 (CSA70系列) SMD Taping (CSA70 Series)

包装记号 Packing code	系列 Series	包装数量 Packing Qty
T	CSA70	2,000

卷盘 Reel

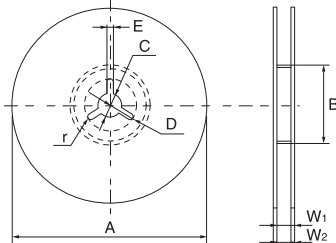

塑料卷盘 (标准型) Reel

单位 unit (mm)

A	B	C	D
$\varnothing 382$ 以下	$\varnothing 50.0$ 以上	$\varnothing 13.0 \pm 0.2$	21 ± 0.8
E	W_1	W_2	r
2.0 ± 0.5	13.0 ± 0.5	18.4以下	1.0

塑料载带 Plastic carrier tape

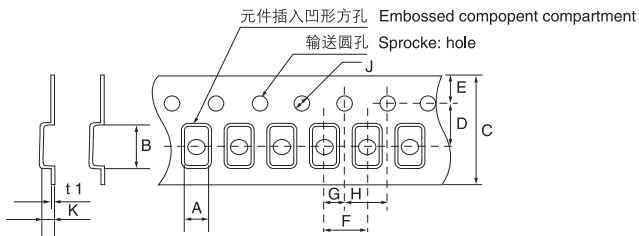

单位 unit (mm)

形状 mark	A	B	C	D	E	F
CSA70	3.60 ± 0.1	4.30 ± 0.1	12.00 ± 0.1	5.50 ± 0.05	1.75 ± 0.1	8.00 ± 0.1
形状 mark	G	H	J	K	t1	
CSA70	2.00 ± 0.05	4.00 ± 0.1	$\varnothing 1.55 \pm 0.05$	2.50 ± 0.1	0.30 ± 0.05	