

Datasheet

LIA-BVD-150-L

Single-Board Dual Phase Lock-In-Amplifier

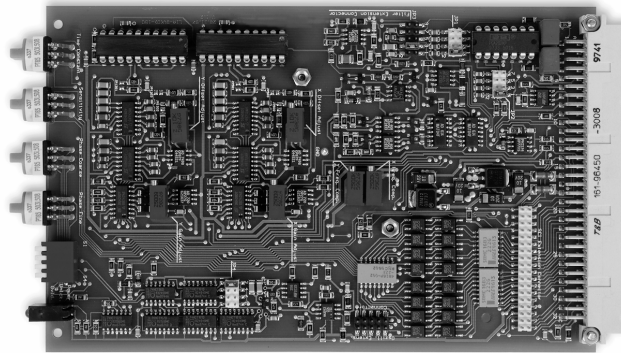

Picture shows Lock-in Amplifier card with optional Mounting Kit LIA- MK- 2 (to be ordered separately)

Features

- Dual Phase Detection with X, Y and Magnitude Output
- Working Frequency 5 Hz ... 10 kHz
- Digital Phase Shifter 0 ... 360°
- Current and Voltage Input
- Parameter Control by local Switches and opto-isolated digital Inputs
- Optional Mounting Kit and Reference Oscillator Modules available

Applications

- Spectroscopy
- Luminescence, Fluorescence, Phosphorescence Measurements
- Light Scattering Measurements
- Opto-electronical Quality Control
- Integration in Industrial and Scientific Measurement-Systems
- Multi-Channel-Systems at moderate Costs

Block Diagram

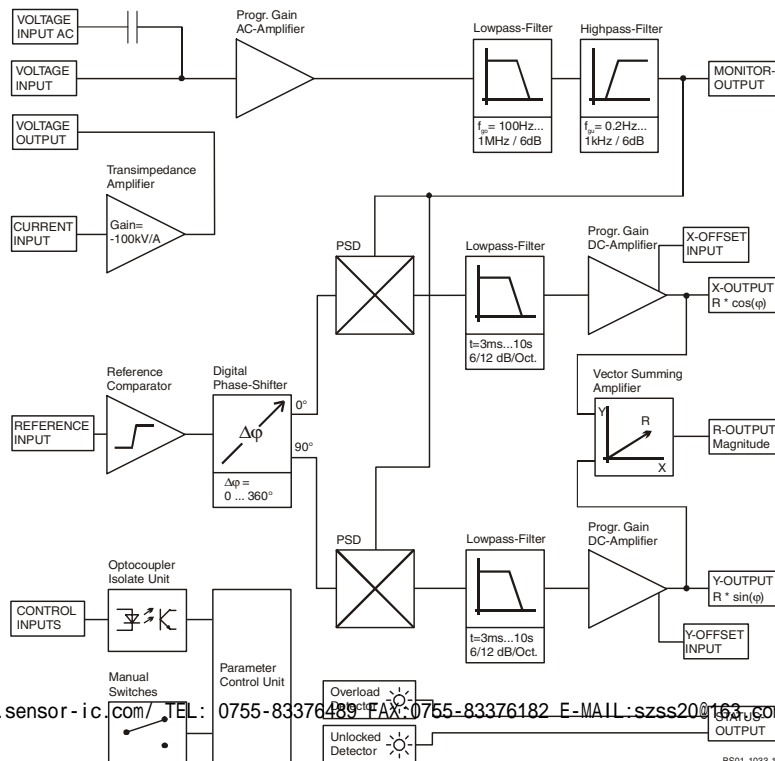

Datasheet**LIA-BVD-150-L****Single-Board
Dual Phase Lock-In-Amplifier**

Specifications	Test Conditions	$V_s = \pm 15\text{ V}$, $T_a = 25^\circ\text{C}$
Voltage Input	Voltage Input Characteristic Voltage Input Range Voltage Input Coupling Voltage Input Impedance Voltage Input Noise Voltage Input CMRR Voltage Input Gain Drift	True Differential Instrumentation-Amplifier 3 μV ... 1V in 1-3-10 steps (for Full Scale Output) AC or DC (selectable at Connector) 1 $\text{M}\Omega$ // 4 pF 12 $\text{nV}/\sqrt{\text{Hz}}$ 110 dB @ 1 kHz, 100 dB @ 10 kHz 100 ppm/K
Current Input	Current Input Characteristic Current Input Range Current Input Noise Current Input Source- Capacit. Current Input Gain Error vs. Source Capacitance	Transimpedance-Amplifier, -100 kV/A (inverting) 30 pA ... 10 μA in 1-3-10 steps (for Full Scale Output) 0.4 $\text{pA}/\sqrt{\text{Hz}}$ 10 pF – 500 pF (recommended) Cs f < 10 kHz <hr/> 10 pF < 1 % 100 pF < 1 % 1 nF < 2 %
Signal Filter	Signal Filter Lowpass (-3 dB BW) Signal Filter Highpass (-3 dB BW) Signal Filter Cutoff accuracy Max. Dynamic Reserve	1 MHz *, 100 kHz, 10 kHz, 1 kHz, 100 Hz; 6 dB/Oct. Selectable per jumper 0.2 Hz, 1 Hz, 10 Hz, 100 Hz, 1 kHz; 6 dB/Oct. selectable per jumper $\pm 20\%$ 80 dB
Signal Monitor Output	Signal Monitor Output Gain Signal Monitor Output Voltage Signal Monitor Output Impedance Signal Monitor Output Current Note	1 ... 3333 (depends on Gain-Setting) $\pm 8\text{ V}$ max. 100 Ω $\pm 10\text{ mA}$ max. When using Current Input with low Input Ranges, the Monitor Output may be disabled by opening the soldering jumper at the Board (near JP1) to prevent from recoupling.
Demodulator	Demodulator Dynamic Reserve	15 dB @ Ultra Stable Setting 35 dB @ Low Drift Setting 55 dB @ High Dynamic Setting
Reference Input	Reference Input Voltage Range Reference Input Impedance Reference Acquisition Time	$\pm 100\text{ mV}$... $\pm 5\text{ V}$ @ bip. Mode (0 V Comparator Threshold) - 5 V / +10 V @ TTL Mode (+2 V Comparator Threshold) 1 $\text{M}\Omega$ max. 2 s @ Fast Setting max. 4 s @ Slow Setting
Phase Shifter	Phase Shifter Type Phase Shifter Range Phase Shifter Resolution Phase Shifter Drift Phase Shifter Accuracy Phase Shifter Orthogonality	Digital, Working Frequency 5 Hz ... 10 kHz 0 ... + 360 ° 1.4 ° < 100 ppm/K < 0.3 ° < 0.1 °
Time Constants	Time Constant Range Time Const. Filter Characteristic	3 ms ... 10 s in 1-3-10 steps 6 dB/Oct. or 12 dB/Oct. switchable

Datasheet

LIA-BVD-150-L

Single-Board Dual Phase Lock-In-Amplifier

Specifications (continued) Output	<p>Output Channels X = In Phase, Y = Quadrature, R = Magnitude</p> <p>Output Voltage Range ± 10 V (@ 2 kΩ Load)</p> <p>Output Current ± 5 mA max.</p> <p>Output Impedance 50 Ω</p> <p>Output DC-Stability 5 ppm/K @ Ultra Stable Setting 50 ppm/K @ Low Drift Setting 500 ppm/K @ High Dynamic Setting</p> <p>Output Basic Accuracy 2 % (X and Y-Output) @ sinusoidal input signal 4 % (R-Output) @ sinusoidal input signal</p> <p>Output Voltage Offset Range ± 100 % Full Scale by ± 10 V Control Voltage</p> <p>Output Voltage Offset Control-Voltage Impedance > 2 kΩ</p>																															
Status Indicator LED	<p>Functions Amplifier Overload Status Reference PLL Unlocked Status</p>																															
Digital Control	<p>Control Input Voltage Low: - 0.8 V ... + 0.8 V, High: + 1.8 V ... + 12 V</p> <p>Control Input Current 0 mA @ 0V, 1.5 mA @ + 5 V, 4.5 mA @ + 12V typ.</p> <p>Digital Status Output Voltage Active: + 4.5 V typ., Non Active: 0 V typ.</p> <p>Digital Status Output Current 10 mA max.</p>																															
Power Supply	<p>Supply Voltage ± 15 Vdc ... ± 18 Vdc</p> <p>Supply Current - 60 mA, + 100 mA</p>																															
Case	<p>Board 19" Euro-Card, (100 mm x 160 mm Board)</p> <p>Weight 100 gr. (0.22 lbs)</p>																															
Temperature Range	<p>Storage Temperature - 40 ... + 100 °C</p> <p>Operating Temperature 0 ... + 60 °C</p>																															
Absolute Maximum Ratings	<p>Signal Input AC Voltage 50 Vpp</p> <p>Signal Input DC Voltage ± 70 V</p> <p>Reference Input Voltage ± 15 V</p> <p>Control Input Voltage - 5 V, + 15 V</p> <p>Power Supply Voltage ± 22 V</p>																															
Switch Settings	<p>4 Dip Switch - Presettings</p> <table border="1"> <thead> <tr> <th>Switch</th> <th>OFF</th> <th>ON</th> </tr> </thead> <tbody> <tr> <td>S1</td> <td>Low Drift & High Dynamic</td> <td>Ultra Stable & Low Drift</td> </tr> <tr> <td>S2</td> <td>1-f Mode</td> <td>2-f Mode</td> </tr> <tr> <td>S3</td> <td>Fast PLL-Locking</td> <td>Slow PLL-Locking</td> </tr> <tr> <td>S4</td> <td>Reference-Input-Threshold = 0 V</td> <td>Reference-Input-Threshold = +2 V</td> </tr> </tbody> </table> <p>Sensitivity Setting, Output DC-Gain Modes</p> <table border="1"> <thead> <tr> <th>Mode</th> <th>DC-Gain</th> <th>Dyn. Reserve</th> <th>DC-Stability</th> </tr> </thead> <tbody> <tr> <td>Ultra Stable</td> <td>10</td> <td>Low</td> <td>High</td> </tr> <tr> <td>Low Drift</td> <td>100</td> <td>Medium</td> <td>Medium</td> </tr> <tr> <td>High Dynamic</td> <td>1000</td> <td>High</td> <td>Low</td> </tr> </tbody> </table> <p>If only low dynamic reserve is required, select the higher DC-Stability settings. Use Dip switch S1 to preselect either the two upper or the two lower DC-Gain modes, then select best mode by Sensitivity switch settings 0-7 or 8-F.</p>	Switch	OFF	ON	S1	Low Drift & High Dynamic	Ultra Stable & Low Drift	S2	1-f Mode	2-f Mode	S3	Fast PLL-Locking	Slow PLL-Locking	S4	Reference-Input-Threshold = 0 V	Reference-Input-Threshold = +2 V	Mode	DC-Gain	Dyn. Reserve	DC-Stability	Ultra Stable	10	Low	High	Low Drift	100	Medium	Medium	High Dynamic	1000	High	Low
Switch	OFF	ON																														
S1	Low Drift & High Dynamic	Ultra Stable & Low Drift																														
S2	1-f Mode	2-f Mode																														
S3	Fast PLL-Locking	Slow PLL-Locking																														
S4	Reference-Input-Threshold = 0 V	Reference-Input-Threshold = +2 V																														
Mode	DC-Gain	Dyn. Reserve	DC-Stability																													
Ultra Stable	10	Low	High																													
Low Drift	100	Medium	Medium																													
High Dynamic	1000	High	Low																													

Datasheet

LIA-BVD-150-L

Single-Board Dual Phase Lock-In-Amplifier

Switch Settings (continued)

S1 = ON: Sensitivity Setting
for Full Scale (= 10 V Output)

Ultra Stable Mode

Setting	Voltage	Current
0	1 V	10 μ A
1	300 mV	3 μ A
2	100 mV	1 μ A
3	30 mV	300 nA
4	10 mV	100 nA
5	3 mV	30 nA
6	1 mV	10 nA
7	300 μ V	3 nA

Low Drift Mode

Setting	Voltage	Current
8	100 mV	1 μ A
9	30 mV	300 nA
A	10 mV	100 nA
B	3 mV	30 nA
C	1 mV	10 nA
D	300 μ V	3 nA
E	100 μ V	1 nA
F	30 μ V	300 pA

S1 = OFF: Sensitivity Setting
for Full Scale (= 10 V Output)

Low Drift Mode

Setting	Voltage	Current
0	100 mV	1 μ A
1	30 mV	300 nA
2	10 mV	100 nA
3	3 mV	30 nA
4	1 mV	10 nA
5	300 μ V	3 nA
6	100 μ V	1 nA
7	30 μ V	300 pA

High Dynamic Mode

Setting	Voltage	Current
8	10 mV	100 nA
9	3 mV	30 nA
A	1 mV	10 nA
B	300 μ V	3 nA
C	100 μ V	1 nA
D	30 μ V	300 pA
E	10 μ V	100 pA
F	3 μ V	30 pA

Time Constant Setting

Setting	6 dB/Oct.	12 dB/Oct.	Time Constant
0	8		3 ms
1	9		10 ms
2	A		30 ms
3	B		100 ms
4	C		300 ms
5	D		1 s
6	E		3 s
7	F		10 s

Phase Shift Setting

Phase shift is adjusted by 2 phase switches with 8 Bit resolution. Values 0 ... 255 (Hex 00 ... FF) correspond to phase shift setting 0 ... +360°. One step with switch marked "Coarse" changes phase shift by 22.5°. The "Fine"-switch changes phase shift by 1.4° - steps:

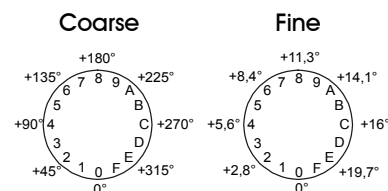

If 2-f Mode is selected, the resolution of digital phase control changes to 2.8° and the phase shift range doubles to 0 ... + 720°.

Jumper Settings

Input Signal Filter

Set Cut-Off Frequency of Input Lowpass Filter

Datasheet

LIA-BVD-150-L

Single-Board Dual Phase Lock-In-Amplifier

Setting	with JP1 + JP2 (always same position) and Highpass Filter with JP3:			
	JP3	Highpass -3 dB Cut-Off	JP1, JP2	Lowpass -3 dB Cut-Off
	3 - 4	0.2 Hz	1 - 2	100 Hz
	1 - 3	1 Hz	3 - 4	1 kHz
	2 - 4	10 Hz	5 - 6	10 kHz
	3 - 5	100 Hz	7 - 8	100 kHz
	4 - 6	1 kHz	none	1 MHz
Frequency Range Selection	JP4	Frequency Range		
	1 - 2	normal operation		
	3, 4, 5, 6, 7, 8	test pins, do not use		

Jumper Position Diagram

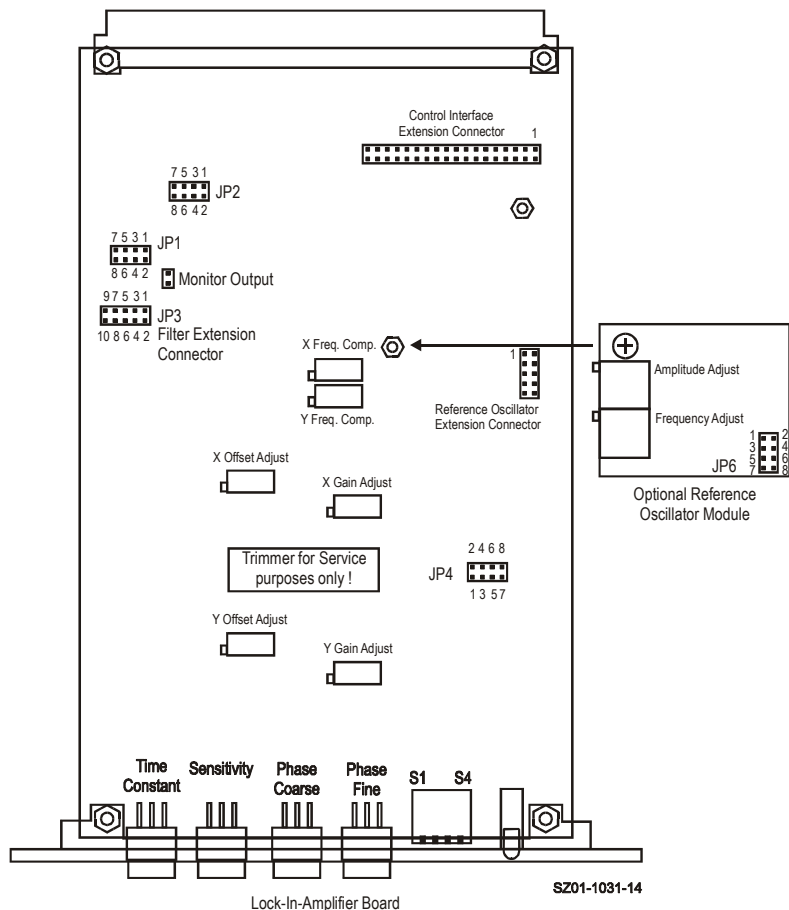

Datasheet**LIA-BVD-150-L****Single-Board
Dual Phase Lock-In-Amplifier**

Connector	Connector Type	Euro-Card DIN 41612 Connector, 64 pin male, (a+c)	
	Input	Pin C2:	Voltage Input, Non Inverting, DC-Coupled
		Pin C3:	Voltage Input, Non Inverting, AC-Coupled
		Pin C4:	Voltage Input, Inverting, AC-Coupled
		Pin C5:	Voltage Input, Inverting, DC-Coupled
		Pin C7:	Current Input
		Pin C6:	Current Amplifier Voltage Output
		Pin A2- A6:	Input GND
	Monitor Output	Pin C9:	Monitor Output
		Pin A9:	Monitor GND
	Output	Pin A12:	R-Signal Output
		Pin C14:	X-Signal Output
		Pin A14:	Y-Signal Output
		Pin C15:	Output GND
	Offset Input	Pin A10:	X-Offset Input
		Pin A11:	Y-Offset Input
		Pin A13:	Offset GND
	Status Output	Pin C10:	Unlocked Status Output
		Pin C11:	Overload Status Output
		Pin C17:	Status Output GND (=Power Supply GND)
	Power Supply	Pin A16+C16:	Power Supply - 15V
		Pin A18+C18:	Power Supply + 15V
		Pin A17+C17:	Power Supply GND
	Remote Control Inputs (Opto-Isolated)	Pin C19:	Time Constant (TC0)
		Pin A19:	Time Constant (TC1)
		Pin C20:	Time Constant (TC2)
		Pin A20:	Time Constant Slope (TCSL)
		Pin A22:	Sensitivity (SEN0)
		Pin C21:	Sensitivity (SEN1)
		Pin A21:	Sensitivity (SEN2)
		Pin C22:	Dynamic Mode (DYN0)
		Pin A28:	Phase Shift (PH0)
		Pin C28:	Phase Shift (PH1)
		Pin A27:	Phase Shift (PH2)
		Pin C27:	Phase Shift (PH3)
		Pin A26:	Phase Shift (PH4)
		Pin C26:	Phase Shift (PH5)
		Pin A25:	Phase Shift (PH6)
		Pin C25:	Phase Shift (PH7)
		Pin C24:	Disable Local Switch Control
		Pin A23+A24:	Remote Control GND (Common Optocoupler Cathode)
	Reference Input	Pin A32:	Reference Input
		Pin A31:	Reference Input Ground
	Reference Output (Connected only if optional Oscillator Module is installed)	Pin A30:	Reference Output
		Pin A17:	Refer. Output GND (=Power Supply GND)
		Pin A29:	Reference Synchronization Input
	Standard Control Interface (Connected only if optional Control Interface Module (future product) is installed)	Pin C29:	Interface 0
		Pin C30:	Interface 1
		Pin C31:	Interface 2
		Pin C32:	Interface 3

Single-Board Dual Phase Lock-In-Amplifier

Remote Control Operation

General

Remote Control Input Bits are opto-isolated and connected by logical OR to local switch setting.

The 4 hexadecimal switches are 4 Bit-coded as shown in the following table:

Switch Code	MSB			LSB
	Bit 3	Bit 2	Bit 1	Bit 0
0	Low	Low	Low	Low
1	Low	Low	Low	High
2	Low	Low	High	Low
3	Low	Low	High	High
4	Low	High	Low	Low
5	Low	High	Low	High
6	Low	High	High	Low
7	Low	High	High	High
8	High	Low	Low	Low
9	High	Low	Low	High
A	High	Low	High	Low
B	High	Low	High	High
C	High	High	Low	Low
D	High	High	Low	High
E	High	High	High	Low
F	High	High	High	High

For remote control a switch setting, set the local switch to "0" and select the wanted setting via the 4-Bit-code at the corresponding digital inputs.

Disable Local Switches

By forcing Input Bit "Disable Local Switch Control" (Pin C24) to "High", the LIA is set to exclusively remote control operation and the manual switches are out of function.

Sensitivity Switch -
Corresponding Inputs

Bit	Corresponding Control Port Input	
Bit 0	SEN0	(Pin A22)
Bit 1	SEN1	(Pin C21)
Bit 2	SEN2	(Pin A21)
Bit 3	DYNO	(Pin C22)

Time Constant Switch -
Corresponding Inputs

Bit	Corresponding Control Port Input	
Bit 0	TC0	(Pin C19)
Bit 1	TC1	(Pin A19)
Bit 2	TC2	(Pin C20)
Bit 3	TCSL	(Pin A20)

Phase Switch Coarse -
Corresponding Inputs

Bit	Corresponding Control Port Input	
Bit 0	PH4	(Pin A26)
Bit 1	PH5	(Pin C26)
Bit 2	PH6	(Pin A25)
Bit 3	PH7	(Pin C25)

Phase Switch Fine -
Corresponding Inputs

Bit	Corresponding Control Port Input	
Bit 0	PH0	(Pin A28)
Bit 1	PH1	(Pin C28)
Bit 2	PH2	(Pin A27)
Bit 3	PH3	(Pin C27)

Datasheet

LIA-BVD-150-L

Single-Board Dual Phase Lock-In-Amplifier

Remote Control Example

For example, to select a switch setting code "6", you have to connect a "High"- level signal to the corresponding control input pins Bit 1 & Bit 2. Mixed operation, e.g. local phase settings and remote controlled sensitivity setting, is also possible when "Disable Local Switch Control" (Pin C24) is not active ("Low" or just not connected).

Dimensions

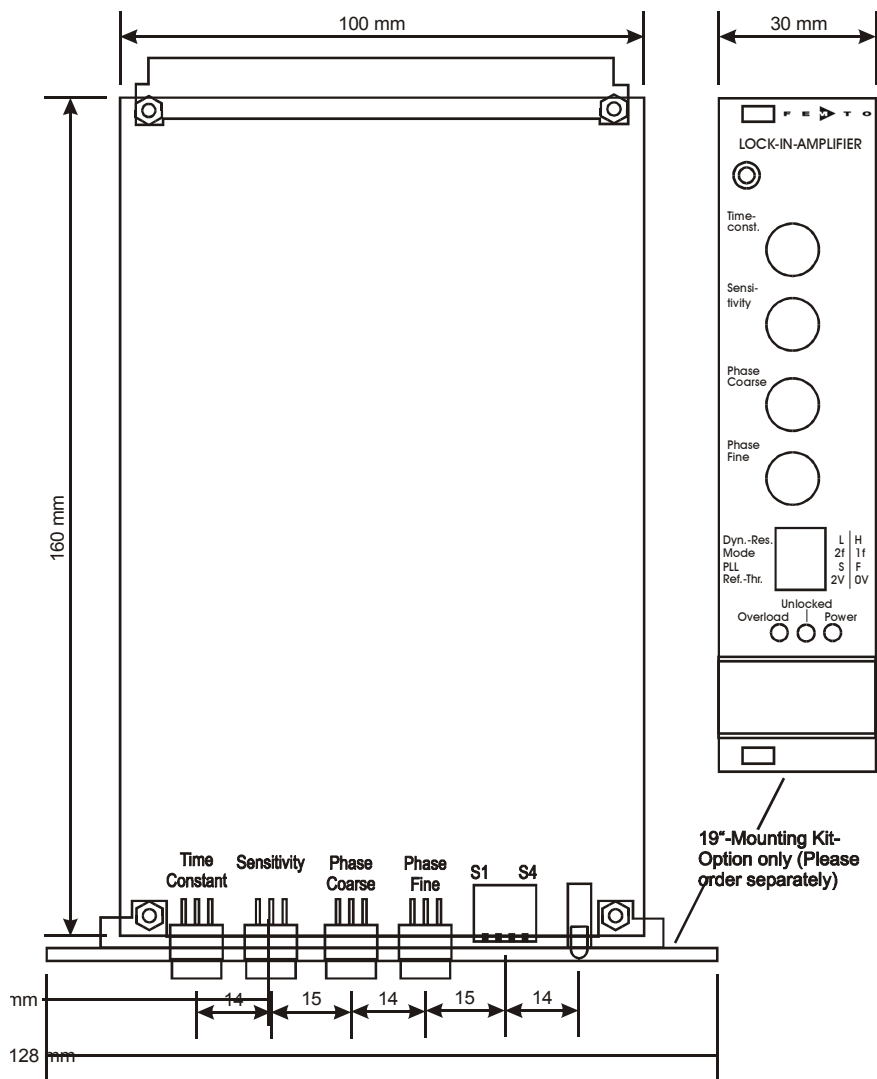



Datasheet

LUCI-10

**USB to D-Sub Control Interface
for FEMTO Amplifiers**



Features	<ul style="list-style-type: none"> • Compact Digital I/O Interface for USB Remote Control of FEMTO Amplifiers • Supports Opto-Isolation of Amplifier Signal Path from PC USB Port • 16 Digital Outputs, 3 Opto-Isolated Digital Inputs • Bus-Powered Operation • System Driver, Application Software and VI's for use with LabVIEW™ Included
Applications	<ul style="list-style-type: none"> • Remote Control of FEMTO® Amplifiers and Photoreceivers Directly from a PC
Block Diagram	<p style="text-align: right;">BS-LUCI-10_R1</p>

Hardware Specifications	<table border="0"> <tr> <td data-bbox="259 1617 470 1648">General Characteristics</td> <td data-bbox="535 1617 730 1648">Bus Interface</td> <td data-bbox="844 1617 1055 1648">USB 2.0 (full-speed)</td> </tr> <tr> <td></td> <td data-bbox="535 1648 730 1680">Digital I/O Channels</td> <td data-bbox="844 1648 1055 1680">16 output lines 3 opto-isolated input lines</td> </tr> <tr> <td></td> <td data-bbox="535 1701 617 1732">Supply</td> <td data-bbox="844 1701 1299 1764">PC USB port, + 5 V, typ. 100 mA, bus-powered (no auxiliary power supply required)</td> </tr> <tr> <td></td> <td data-bbox="535 1764 649 1795">Connectors</td> <td data-bbox="844 1764 974 1795">USB type A D-Sub, 25 pin, male</td> </tr> <tr> <td></td> <td data-bbox="535 1816 600 1848">Cable</td> <td data-bbox="844 1816 1055 1848">AWG 28, length 1.8 m</td> </tr> <tr> <td data-bbox="259 1869 324 1900">Output</td> <td data-bbox="535 1869 730 1900">Number of Channels</td> <td data-bbox="844 1869 1380 1932">16 output lines, supporting opto-isolation inside FEMTO amplifiers and photoreceivers</td> </tr> <tr> <td></td> <td data-bbox="535 1932 730 1963">Output Voltage Range</td> <td data-bbox="844 1932 1380 1995">LOW bit: 0 ... + 0.5 V (@ 0 ... 2 mA output current) HIGH bit: + 4 ... + 5.5 V (@ 0 ... 2 mA output current)</td> </tr> <tr> <td></td> <td data-bbox="535 1995 730 2047">Max. Current Writing Rate</td> <td data-bbox="844 1995 1055 2047">6 mA per channel max. 800 operations per second</td> </tr> </table> <p>SUNSTAR自动化 http://www.sensor-ic.com/ TEL: 0755-83376489 FAX: 0755-83376182 E-MAIL: szss20@163.com</p>	General Characteristics	Bus Interface	USB 2.0 (full-speed)		Digital I/O Channels	16 output lines 3 opto-isolated input lines		Supply	PC USB port, + 5 V, typ. 100 mA, bus-powered (no auxiliary power supply required)		Connectors	USB type A D-Sub, 25 pin, male		Cable	AWG 28, length 1.8 m	Output	Number of Channels	16 output lines, supporting opto-isolation inside FEMTO amplifiers and photoreceivers		Output Voltage Range	LOW bit: 0 ... + 0.5 V (@ 0 ... 2 mA output current) HIGH bit: + 4 ... + 5.5 V (@ 0 ... 2 mA output current)		Max. Current Writing Rate	6 mA per channel max. 800 operations per second
General Characteristics	Bus Interface	USB 2.0 (full-speed)																							
	Digital I/O Channels	16 output lines 3 opto-isolated input lines																							
	Supply	PC USB port, + 5 V, typ. 100 mA, bus-powered (no auxiliary power supply required)																							
	Connectors	USB type A D-Sub, 25 pin, male																							
	Cable	AWG 28, length 1.8 m																							
Output	Number of Channels	16 output lines, supporting opto-isolation inside FEMTO amplifiers and photoreceivers																							
	Output Voltage Range	LOW bit: 0 ... + 0.5 V (@ 0 ... 2 mA output current) HIGH bit: + 4 ... + 5.5 V (@ 0 ... 2 mA output current)																							
	Max. Current Writing Rate	6 mA per channel max. 800 operations per second																							

USB to D-Sub Control Interface for FEMTO Amplifiers

Software Specifications

Software
(included on CD)

Device Driver	dynamic link library (DLL) for integration in Microsoft Windows® operating system for use with C/C++, LabWindows™ /CVI™ or LabVIEW™
Application Software	GUI (graphical user interface) programs for simple remote control of FEMTO amplifiers and photoreceivers provided as executable programs and LabVIEW projects
LabVIEW Programs	sample programs to control and test the LUCI-10 hardware (including front panel and block diagram)
LabVIEW Library	special VI toolkit for integration in LabVIEW development environment

Note: A National Instruments LabVIEW™ license is not included in this software package. For use of the GUI application programs the LabVIEW Run-Time Engine is required. If not detected on the host PC during the installation process the LabVIEW Run-Time Engine will be installed automatically from the CD.

System Requirements

Operating System	Microsoft Windows XP with Service Pack 2, or higher
Processor	Intel Pentium III or AMD Athlon, or better
System Memory	512 MB of RAM, or more
Hard Disk Space	about 200 MB
Interface Port	USB 1.1 or USB 2.0
Supported FEMTO Modules	any standard FEMTO amplifier or photoreceiver with 25 pin D-Sub socket, except model HLVA-100

Optional Requirements

For development of own application programs an additional development environment like LabVIEW Version 8 (or higher) or C/C++ is required.

Legal Notice

LabVIEW, CVI, National Instruments and NI are trademarks of National Instruments. Neither FEMTO Messtechnik GmbH, nor any software programs or other goods or services offered by FEMTO Messtechnik GmbH, are affiliated with, endorsed by, or sponsored by National Instruments.

The mark LabWindows is used under a license from Microsoft Corporation.

Microsoft and Windows are either registered trademarks or trademarks of Microsoft Corporation in the United States and/or other countries.

FEMTO and the FEMTO logo are trademarks or registered trademarks of FEMTO Messtechnik GmbH in Germany, the U.S. and/or other countries.

Product and company names mentioned may also be trademarks or trade names of their respective companies used here for identification purposes only.

**USB to D-Sub Control Interface
for FEMTO Amplifiers**

Dimensions

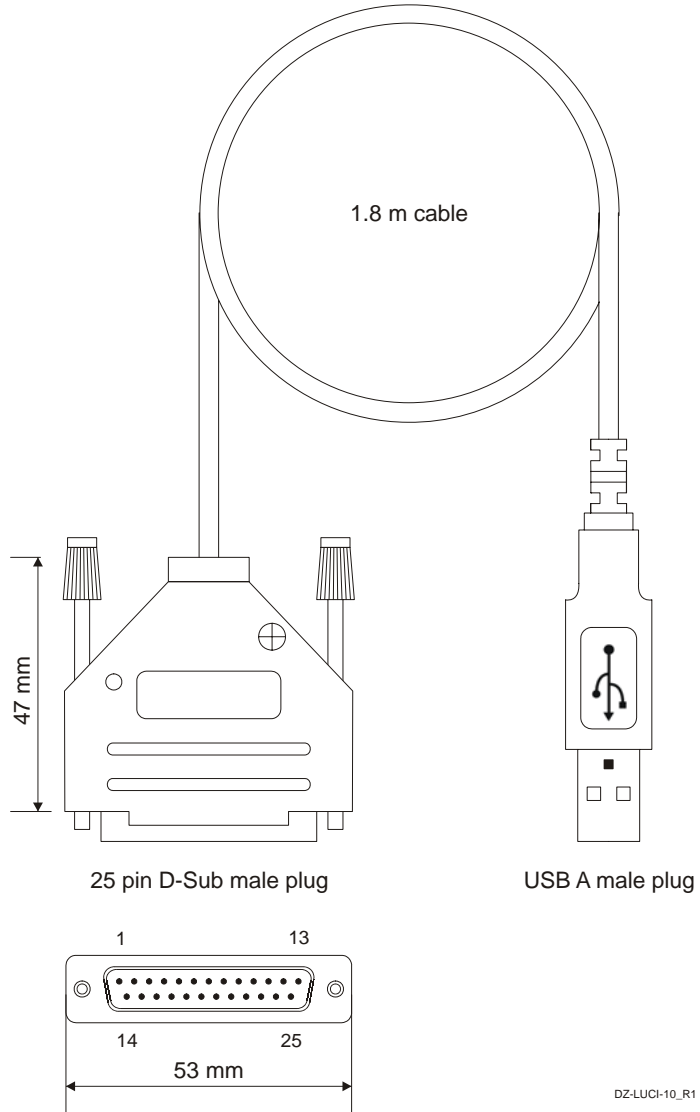

FEMTO Messtechnik GmbH
Paul-Lincke-Ufer 34
D-10999 Berlin · Germany
Tel.: +49 (0)30 – 4 46 93 86
Fax: +49 (0)30 – 4 46 93 88
e-mail: info@femto.de
<http://www.femto.de>

Specifications are subject to change without notice. Information furnished herein is believed to be accurate and reliable. However, no responsibility is assumed by FEMTO Messtechnik GmbH for its use, nor for any infringement of patents or other rights granted by implication or otherwise under any patent rights of FEMTO Messtechnik GmbH. Product names mentioned may also be trademarks used here for identification purposes only.
© by FEMTO Messtechnik GmbH
Printed in Germany

Y
(Lochbild)
(board drillings)

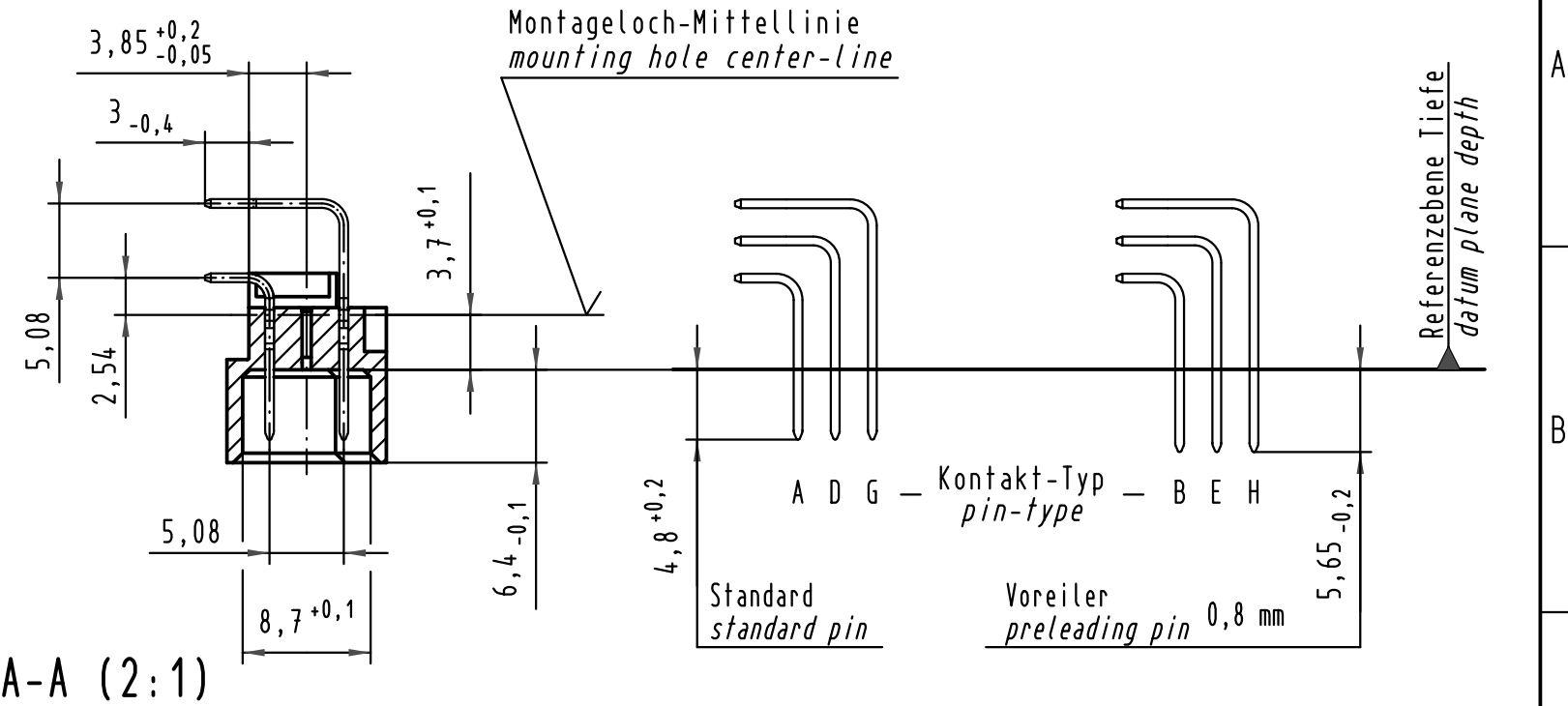
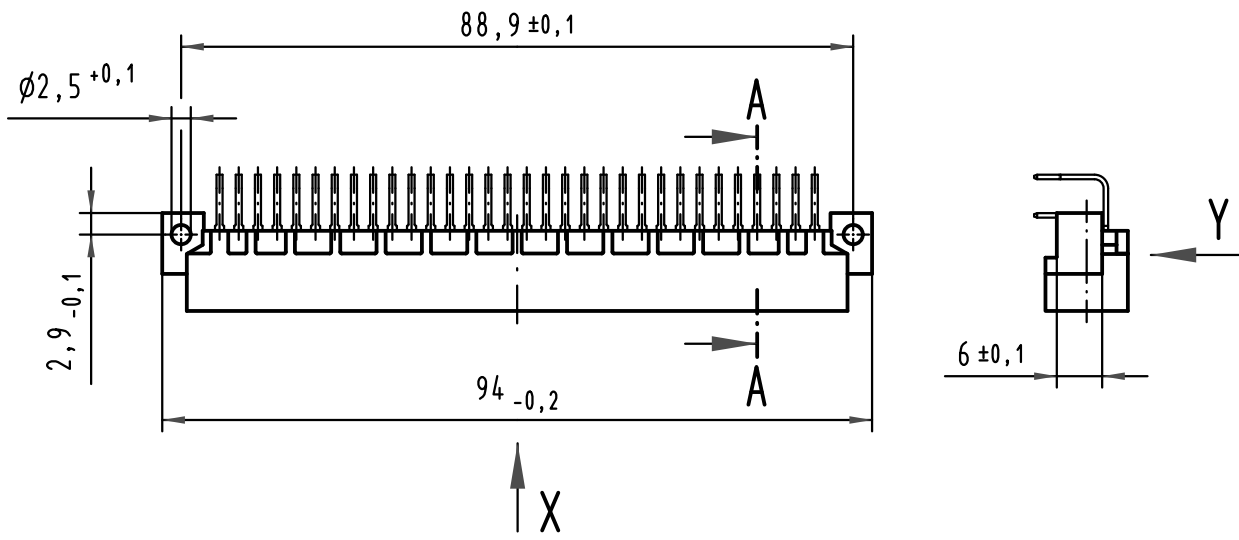
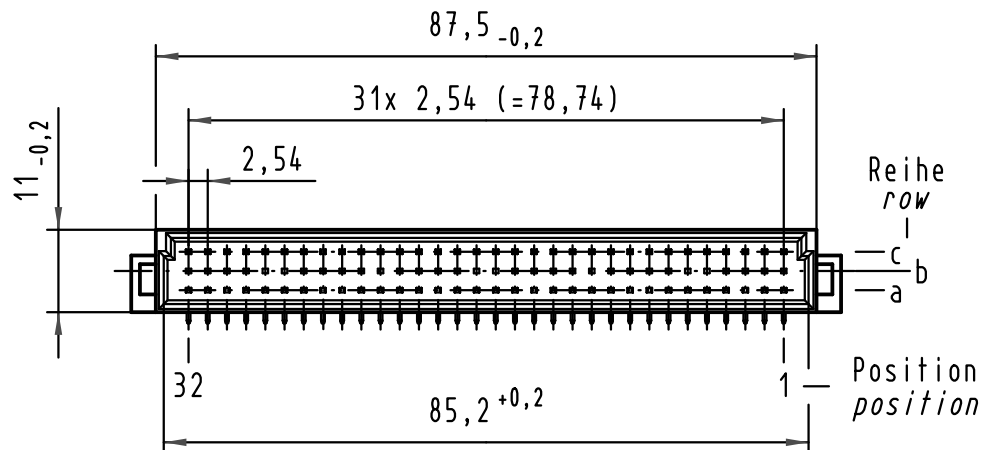
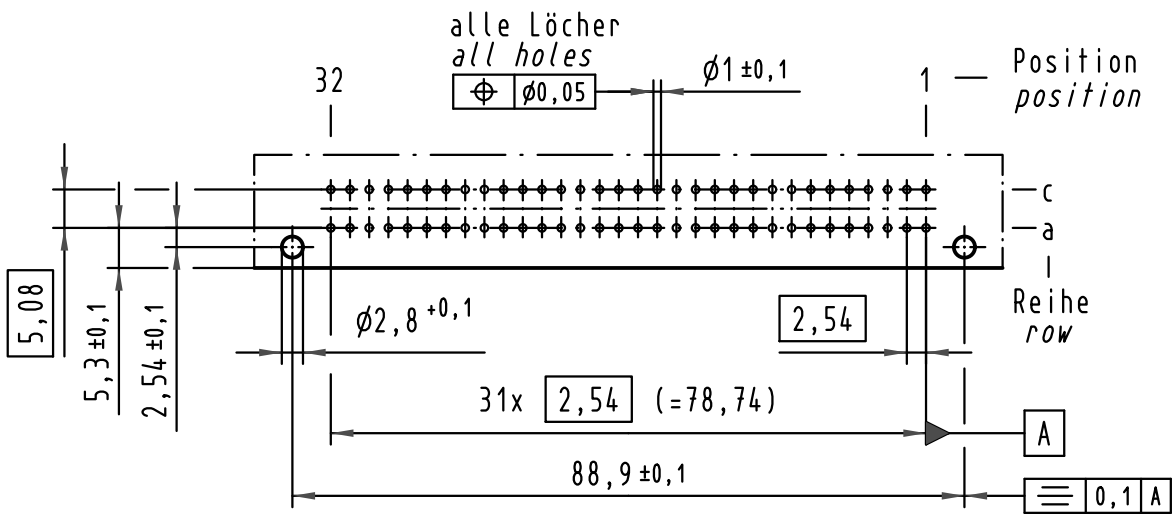

X Kontaktbelegung
contact loading

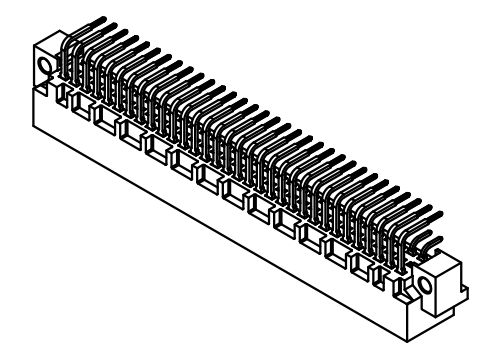
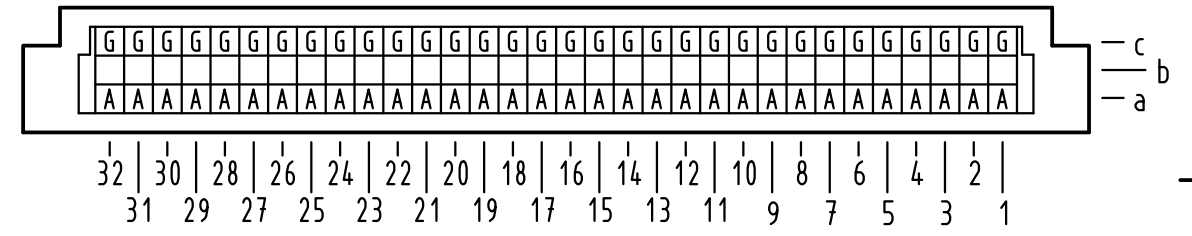

① weitere Informationen siehe: DS 09 03 120 02 01
further information see: DS 09 03 120 02 01

09 03 164 7921	3
09 03 164 6921	2
09 03 164 2921	1
Bestell-Nr. part-no.	Anforderungsstufe performance level ①

All Dimensions in mm Original Size DIN A 3		Techn. Character.			Nicht tolerierte Maßel/Free size tolerances IEC 60603-2	
Mod.	Dat.	Name	Dat.	Name	Maßstab/Scale	Bauform C Messerleiste Einlöt, 64 pol. type C male connector solder, 64 pol.
36054	11.06.10	Hage.	Detail.	15.05.00	Rie.	
36042	21.05.10	Hage.	Insp.	15.05.00	Pa.	
35345	15.10.08	Hage.	Stand.			HARTING Electronics GmbH & Co. KG D-32339 ESPELKAMP 
34650	12.10.07	Hage.				
27477						
TB 09 03 164 x921						Blatt/page

Alle Rechte vorbehalten/ All rights reserved