



## The universal amplifier for photodiodes with built-in cooler **AMT-07M**

### Operations manual

## Contents

1. Application	3
2. Features	3
3. Service conditions	4
4. Appearance of the amplifier and its interface	5
5. Operating instruction	7
6. Technical characteristics	11
7. Block diagram	12

## **1. Application.**

The amplifier AMT-07M is designed for signal extraction and detection from IR-photodiode with built-in cooler manufactured by IBSG.

## **2. Features.**

- The possibility of discrete changing of current amplification to raise the measurement accuracy.
- The presence of analog output for external device connection and LCD-display for signal level indication.
- The intrinsic function for background level compensation.
- On board temperature controller provides select and stabilize of the temperature on the PD's chip in wide range. This gives possibility to tune and stabilize the photodiode spectral characteristics.

### 3. Service conditions.

Temperature tolerance	-15 °C..+15 °C
Relative air humidity (at temperature + 35°C)	less then 80 %
Atmospheric pressure	86..107 kPa

## 4. Appearance of the amplifier and its interface.

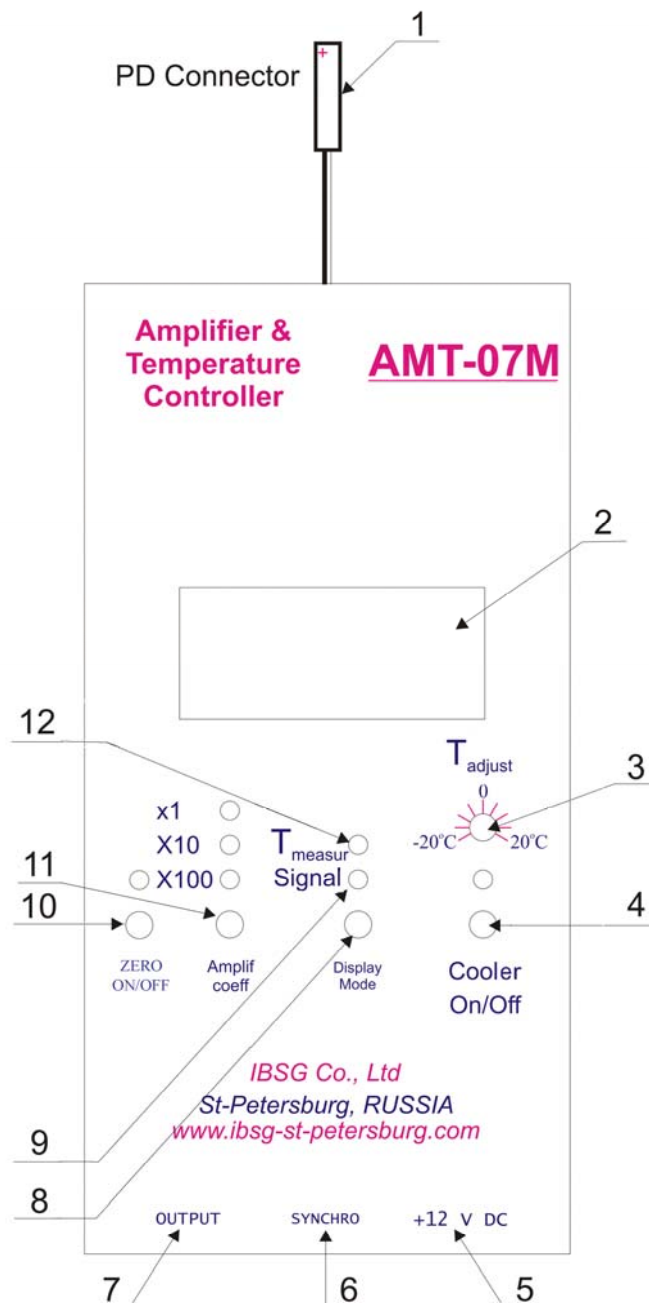

**Fig.1.** Appearance of the amplifier and its interface.

1. The jack for the PD connection.
2. The display for indication of the PD temperature and signal level.
3. The PD temperature adjuster.
4. The start/stop button of PD cooling.
5. The jack for the cable of AC/DC adapter.
6. The jack for synchronization cable.
7. The jack for external device connection (analog output).
8. The button of display mode selection.
9. The LED indicator of the signal level indication mode.
10. The start/stop button of “ZERO” mode.
11. The button of discrete changing of current amplification.
12. The LED indicator of the PD temperature indication mode.

## 5. Operating instruction.

1. Please take a PD with a cooler. Carefully combine its wires with pins of connector “PD” (1) tightly till fixation (fig.2).

**Note!** Marked with the red point pin of connector “PD” must be connected with the appropriate red wire of the PD (fig.2). In the case of wrong junction the PD can be damaged.

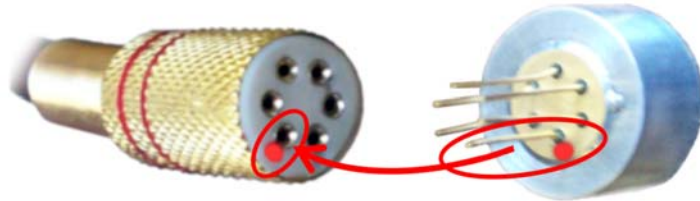

**Fig.2.** Observance of polarity during the connection between the PD and the PD connector (1).

2. With the help of the synchronization cable connect the amplifier AMT-07M (jack “SYNCRO” (6)) with the LED driver (for example with D-31 or DLT-37). Figure 3.

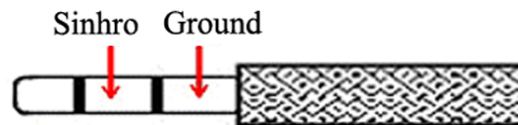

**Fig.3.** The polarity of jackplug of cable for synchronization.

**Note!** Without synchronization the amplifier readings can't be true.

3. If necessary with the help of a cable connect the “Output” (7) of AMT-07M with recording instrument (for example oscilloscope or analog-to-binary converter). Figure 4.

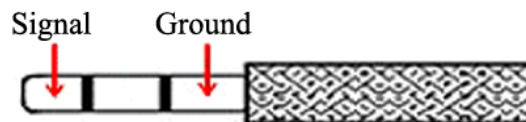

**Fig.4.** The polarity of jackplug of cable for external device connection.

4. Insert the jackplug of cable of AC/DC adapter into connector "+12V DC" (5). The AMT-07M is operationally ready. Figure 5.



**Fig.5.** The polarity of jackplug of power cable.

5. Using the button “Display mode” (8) select the PD temperature indication mode. The green LED indicator “ $T_{\text{measure}}$ ” (12) will be turned on. On the LC display you can see (2) the real temperature of the PD’s chip.



**Fig.6.** The button of display mode selection and the LED indicator of the PD temperature indication mode.

6. Set the adjuster “ $T_{\text{adjust}}$ ” (3) to the extreme right position which corresponds to the maximum value of PD temperature.

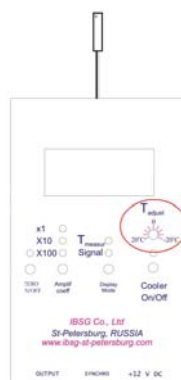

**Fig.7.** The PD temperature adjuster.

7. Switch on the PD cooling by pushing the button “Cooler ON/OFF” (4). The green LED indicator “Cooling” will be turned on. After that, slowly rotate the adjuster “ $T_{\text{adjust}}$ ” (3) clockwise until the real temperature of the PD’s chip will be correspond to the requisite value of it.



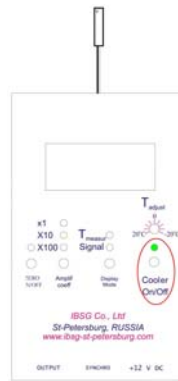

**Fig.8.** The start/stop button of PD cooling with appropriate indicator.

8. Using the button “Display mode” (8) select the PD current indication mode. The green LED indicator “Signal” (9) will be turned on.

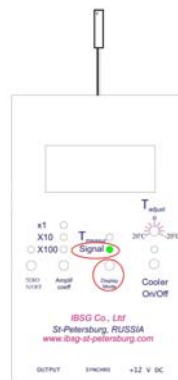

**Fig.9.** The button of display mode selection.  
The LED indicator of the signal level indication mode.

**NOTE!** The signal level is printed on the display in conventional units.

9. Using the button “Amplif.coef” (11) select the requisite value of current amplification. The appropriate LED indicator will be turned on (“×1”, “×10” or “×100”). If the amplification of using PD will be too big you will see on the display the symbol “1\_\_\_”. In that case, the coefficient of amplification should be decreased.

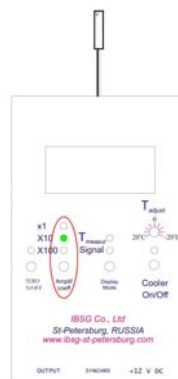
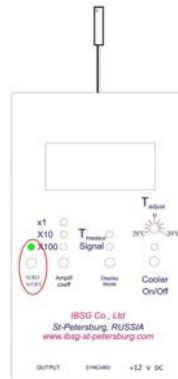

**Fig.10.** The button and indicators of discrete changing of current amplification.

## “ZERO” mode description.

The intrinsic function for background level compensation (“ZERO” mode) is used for amplification and measuring the difference between the current signal level and the signal taken for the zero level.

Using the start/stop button “ZERO ON/OFF” (10) this mode can be switched. The appropriate green LED indicator will be turned and the current signal is taken for the zero level in power up time.



**Fig.11.** The start/stop button and LED indicator of “ZERO” mode.

## 6. Technical characteristics.

Input voltage	+12 V, stabilized
Voltage tolerance	-5..+5 %
Power consumption	Less then 3 W
Adjustment temperature range	-15 °C..+15 °C
Board dimensions	148×78×30 mm
Maximal amplification	6,4×10 <sup>6</sup> V/A
Maximal amplitude of output voltage	± 4 V
Output resistance	50 ohm
Transmission band with PD24	0,5 kHz – 20 kHz
Transmission band with PD25	0,5 kHz – 1 MHz

## 6. Block diagram

The block diagram of AMT-07M is presented in fig.11. The amplifier functionally consists of the photodetector with PD, temperature sensor RT, Peltier element P and amplification-transformation circuit including preamplifier A1, bandpass amplifier BA, variable gain amplifier A2, synchronous demodulator SD, multiplexer MX, analog-to-digital converter ADC and liquid crystal display LCD, as well as regulating-stabilizer circuit of PD temperature including amplifiers A3, A4 and pulse power supply converter of Peltier element DRVP. The amplifier feeding is implemented with the DC / DC circuit, which is a pulse voltage converter from + 12 V in + 5 V, -5 V. The input voltage of DC / DC converter supplies from +12 VDC jack.

Signal from the output of the photodetector comes to the preamplifier A1. It is enclosed in a metal shield for noise minimization. From the output of the preamplifier A1 the signal comes to the bandpass amplifier BA, which gain the signal in the band from 500 Hz to 50 kHz, and after that to the variable gain amplifier A2. The amplification can be changed by the button "Amplif. Coeff". The value of amplification is indicated by light-emitting diodes "1", "10" and "100".

From the output of the variable gain amplifier A2 the signal comes to the jack OUTPUT and for rectification to the synchronous demodulator SD, which receive clock pulses from the jack SYNCHRO.

The multiplexer MX2 switch the direct voltages from:

- the output of the synchronous demodulator SD (The voltage is proportional to the signal amplitude).
- the potentiometer RP1 (The voltage is proportional to the installed PD temperature).
- the amplifier A3 (The voltage is proportional to the current PD temperature).

Voltage from the output of MX2 feed to the analog-digital converter ADC and then to the liquid-crystal indicator LCD DISPLAY. The display mode can be selected with the help of button "Display mode".

The circuit executed on DRVP, A3, A4 is used for stabilisation and adjustment of PD temperature. Stabilisation and temperature adjustment is carried out by means of Pelte element P. The temperature sensor is based on the thermoresistor RT. The signal from the temperature sensor after amplification by A3 supplies on the first input of the error amplifier A4. The reference voltage from potentiometer RP1 supplies on the second input of A4. The converter DRVP generates the voltage on the Peltier element which changes the temperature of the PD and supports its at the level set by the potentiometer " $T_{adjust}$ ". The DRVP begin working after pressing the button "Cooler ON / OFF". Then cooling is working the light-emitting diode "Start cooling" is shining. Integrated temperature controller allows to maintain the temperature of PD in the range from -10 ° C to +25 ° C.

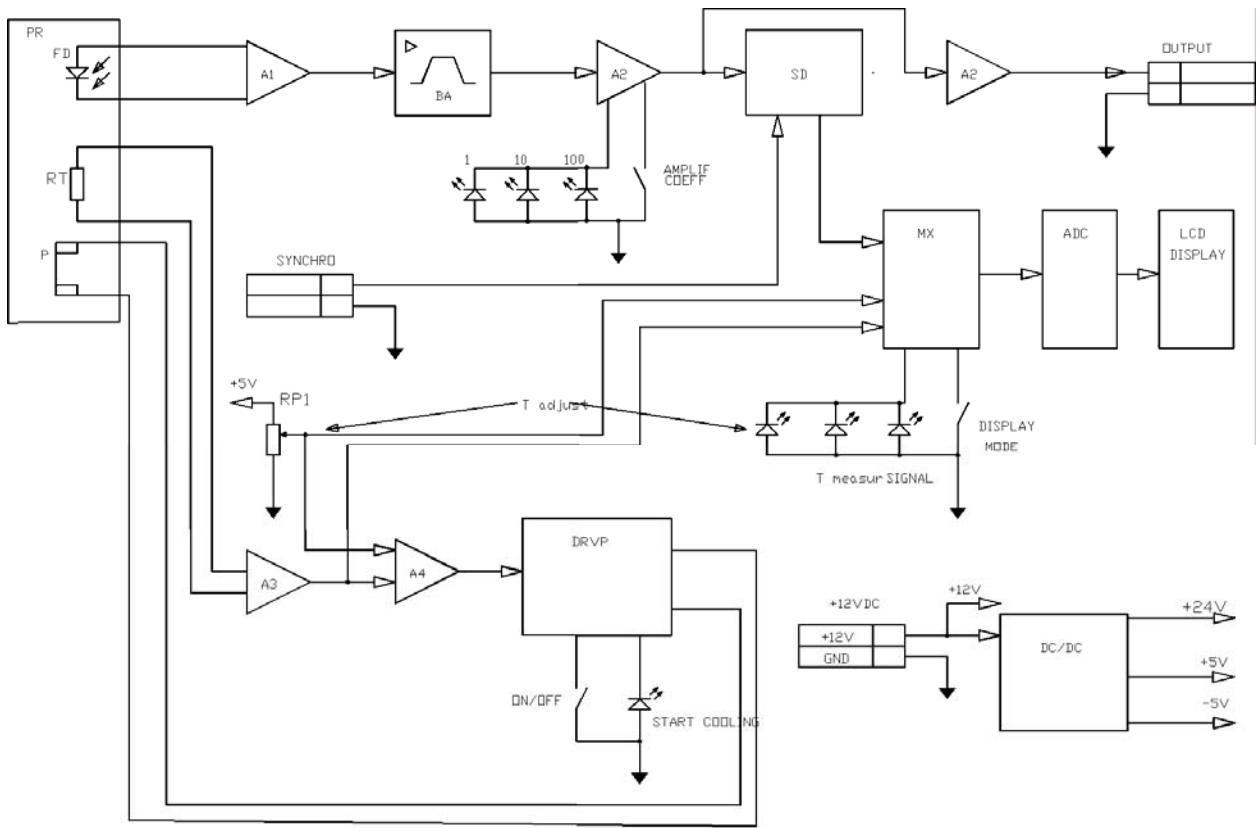

**Fig.12.** The Block diagram of AMT-07M.