



General method of operation of Micro-hotplates

Ilie Poenaru

Micro-hotplates are used as base technology for MOX, electrochemical and catalytic gas sensors. The electrical power is converted by Joule effect in thermal energy and transferred through conduction to the gas sensitive layer. The entire system is built on a micro-membrane for minimal power dissipation. The main requirement of a micro-hotplate is to maintain constant and high temperature on its micro-surface. To minimize the power consumption usually the micro-hotplate must be turned on/off at a frequency of 0.5Hz up to 80Hz, depending on gas sensitive layer response and signal filtering solution.

Increasing the operating temperature above the maximum recommended operation temperature could decrease the life time of micro-heater by breaking the resistive layer or the membrane. Resistive heater layer breakage occurs mainly because of electro-migration and membrane breakage occurs mainly because of mechanical stress built up in the overheated membrane and thus, failure is related to cumulative operating time at temperatures exceeding those recommended. Other factors can affect the micro-hotplate, such as electrical drive mode, package type, ambient temperature, humidity or gas flow.

Electro-migration being the main factor of reducing the lifetime and making to increase the micro-hotplate resistance, the voltage driving has some advantages versus current driving by maintaining constant power dissipation and also keeping constant temperature on the micro-hotplate in operation. A simple solution to manage the micro-surface temperature of a micro-hotplate can be built using an LDO with "Enable" pin, adjustable output voltage and soft start-up. The temperature of the micro-hotplate can be monitored by measuring the micro-hotplate resistance or using the integrated diode and making a feedback loop control circuit for more accurate temperature control or calibration. The linear regulators TPS74801/701 or ISL80101adj are good options for driving a micro-hotplate.

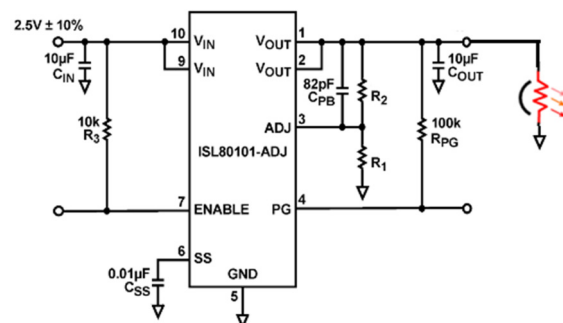
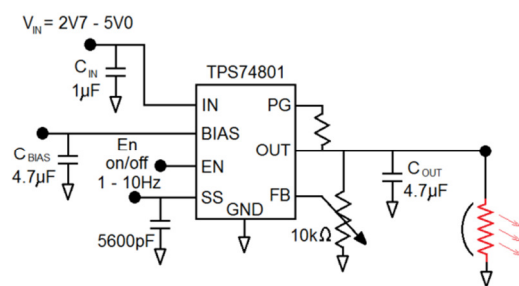

Fig1 Typical driving circuits for a micro-hotplate



The transient response of the micro-hotplates can vary between 15ms and 55ms depending on resistive micro-heater area, membrane area, operation temperature and package. To avoid increasing the thermal gradient of the membrane, a soft start-up is desirable. To minimise the pcb area and use a single power supply system, micro-hotplates can have an N-FET, P-FET and temperature-sensing diode integrated into the device. This can be used for calibration or a temperature feedback loop, see Fig2.

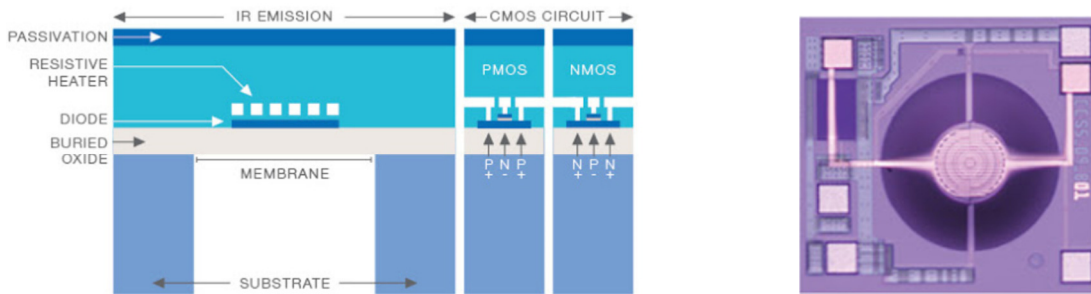

Fig2 Cross section and top view of the micro-hotplate

The temperature of the micro-hotplate is dictated by the voltage applied across the device. Fig3 below shows the Voltage/Temperature relationship for specific CCS IR Sources.

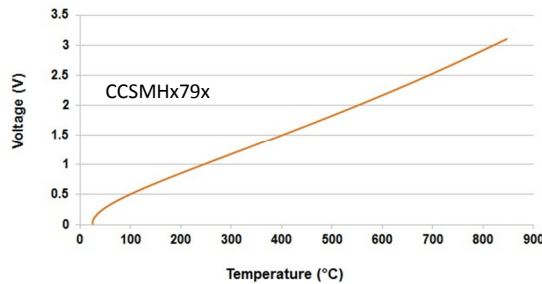
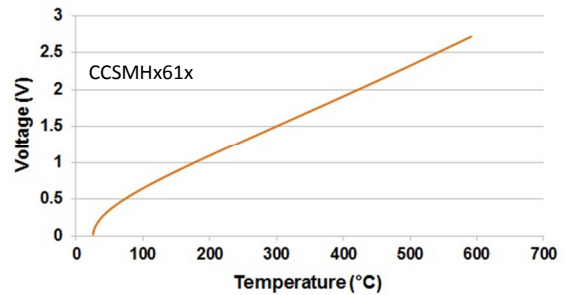
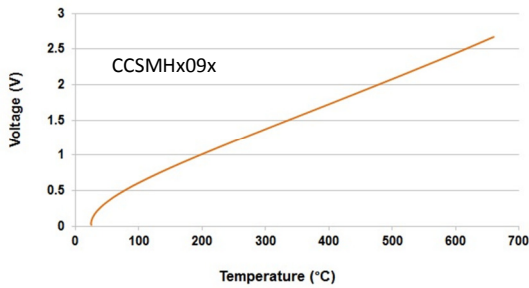

Fig3 Voltage v Temperature graphs, DC operation



Similarly, as the devices are resistive, the temperature is also be related to the current through the device. This relationship is shown in Fig4 below.

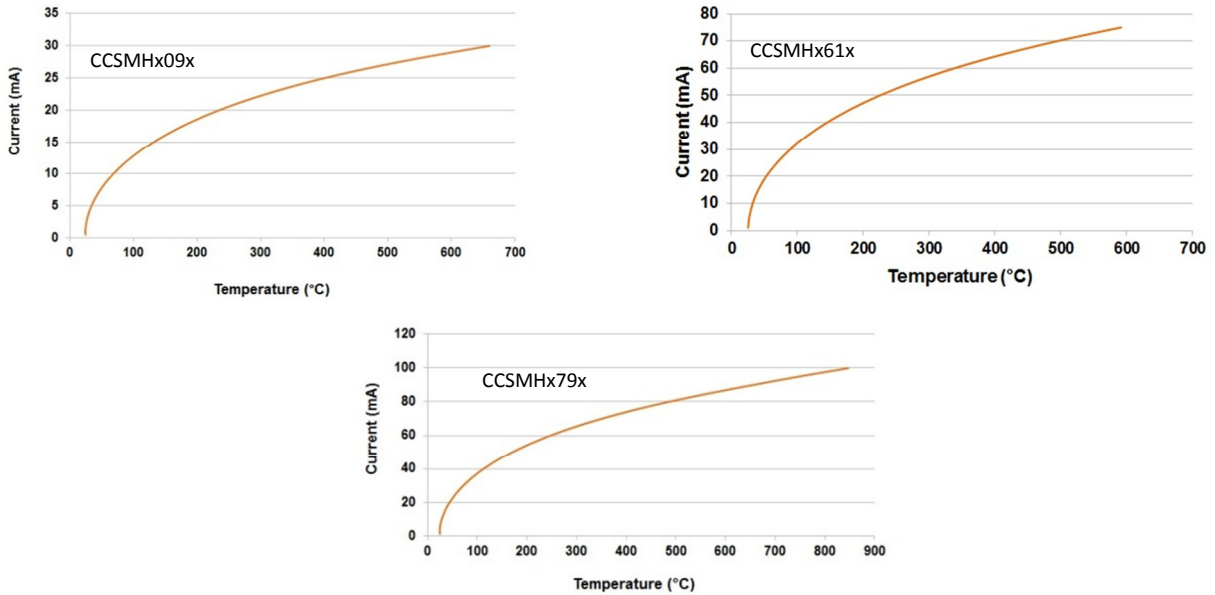

Fig4 Current v Temperature graphs, DC operation

One of the most important factors, however, in choosing an IR Source is the power consumption. CCS IR Sources operate at very low power and the relationship to temperature can be seen in Fig5 below.

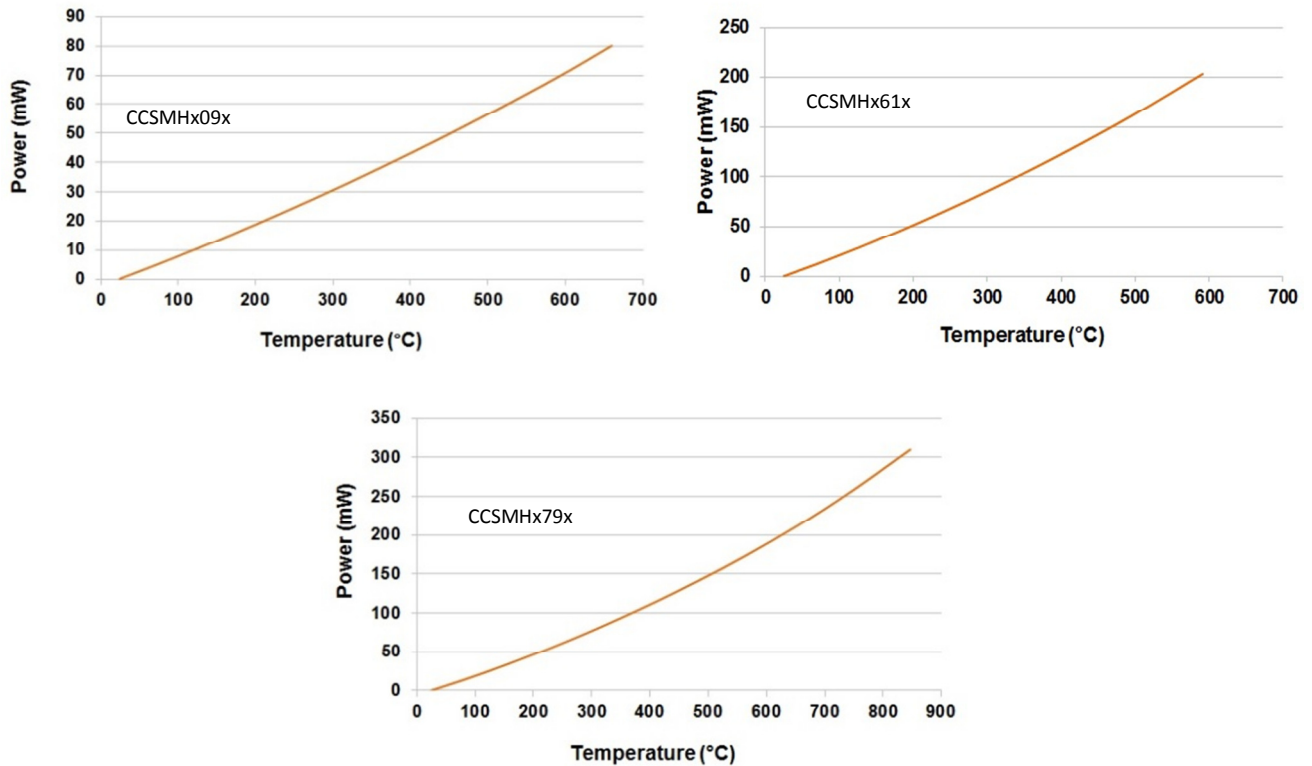

Fig5 Power v Temperature graphs, DC operation



As mentioned above, CCS Micro-Hotplates are also available with built-in temperature-sensing diode and/or FET driver. Details of operation using these options is given in a separate Applications Note.