



<h2>UV - Photodetector with integrated amplifier</h2>	<h2>JIC 137 A JIC 138 A JIC 139 A</h2>
---	--

- characteristics :**
- ◆ integrated UV-A filter
  - ◆ spectral range 315 ... 395 nm
  - ◆ active area 0,22 mm<sup>2</sup>
  - ◆ responsivity, decadic staggering 0,3/3/30 mV/nW
  - ◆ extra sensor pin for external adjustment of gain and bandwidth
  - ◆ single supply voltage
  - ◆ sensor assembly isolated to ground
  - ◆ hermetically welded TO5-metal/glass package
  - ◆ components are in conformity with RoHS and WEEE

- applications :**
- ◆ selective UV-A-measurement
  - ◆ control of sterilization lamps
  - ◆ flamedetection and flamecontrol
  - ◆ control of irradiancy in varnish and adhesive hardening

**absolute maximum ratings:**

supply voltage	+5,5	V
working temperature range	-25 °C ... +85	°C
storage temperature range	-40 °C ... +100	°C
welding temperature (5s)	300	°C

**technical data :**

common test conditions, as not otherwise specified: T<sub>A</sub> = 25 °C, V<sub>S</sub> = +5 V  
typ. values, maximum values in brackets

parameter	test condition	JIC137A	JIC138A	JIC139A	unit
feedback resistor		10	100	1.000	MΩ
dark offset voltage	E = 0 lx	± 1	± 2	± 3	mV
noise voltage	B = 1 kHz	1			mV <sub>rms</sub>
max. spectral responsivity	λ = 340 nm	0,3	3	30	mV/nW
risetime		30	150	600	μs
bandwidth	- 3 dB	10	2	0,5	kHz
saturation voltage	R <sub>L</sub> = 2 kΩ	+ 4,95 (+ 4,8)			V
short current		± 50			mA
supply voltage		+ 2,7...+ 5			V
current consumption		750 (1100)			μA

# JIC 137 A, 138 A, 139 A

## relative spectral responsivity

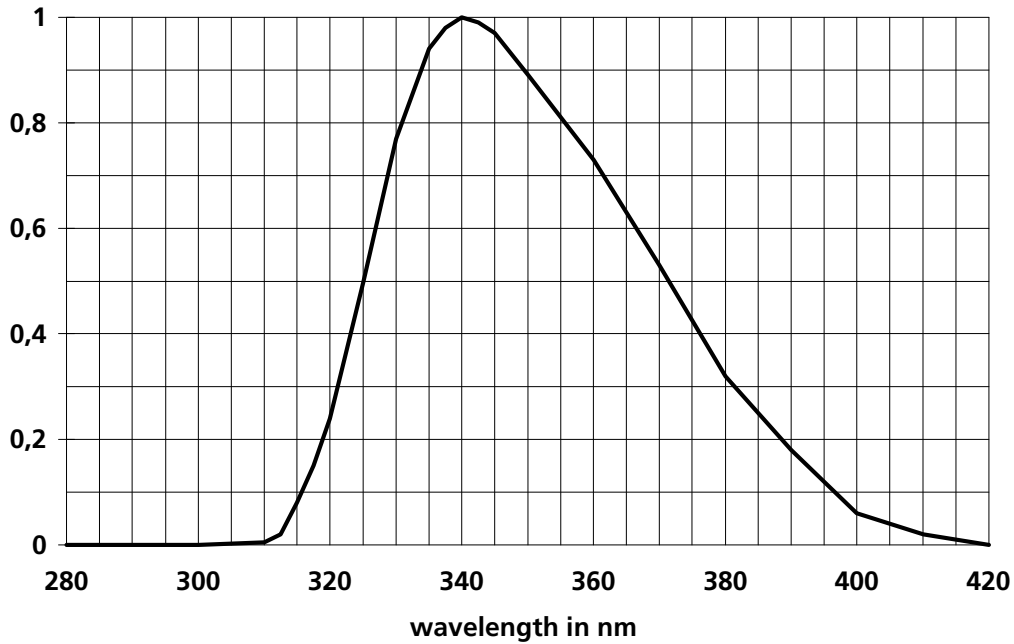

## pin configuration

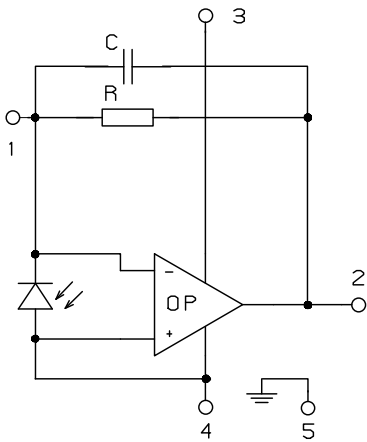

- 1  $R_f$
- 2 Out
- 3  $V_s$
- 4 GND
- 5 Case

## package dimension

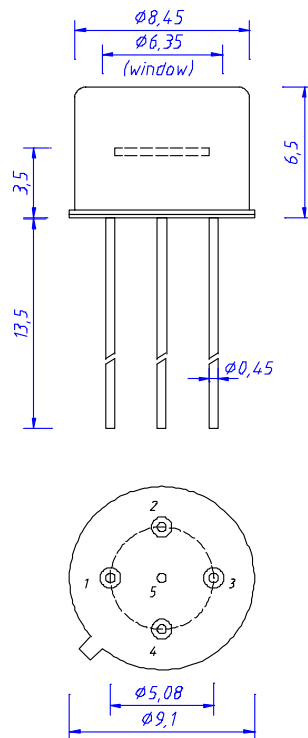

## application hints:

- If an external resistor for reduction of gain is used, please make sure that length of connectors is as short as possible to reduce noise and capacitive interference.
- If internally adjusted gain is used only, please cut pin „1“.