

# SSI Technologies – Application Note PS-AN14

## MediaSensor™ P51 Series HS

### High Pressure Sealed Gage Pressure Sensors

#### Product Description

SSI Technologies Inc., offers the **MediaSensor™ Series HS sealed gage pressure sensors** targeted at industrial and commercial applications where low pressure, cost, compact size, robust packaging, chemical compatibility and performance are critical.

These MediaSensor™ P51 Series HS bulk micro-machined, sealed gage pressure sensors are designed to work at low pressure ranges (**1000 psi to 5000 psi**) with superior *accuracy*.

The MediaSensor™ P51 Series HS pressure sensor are cost competitive, compact, have robust packaging with a wide variety of fittings that work in both harsh and benign media. They are ideal for a variety of pressure measurement applications in the automotive, industrial and commercial industries. Four different electrical signal outputs are available for use by computers, digital panel meters, PLCs, chart recorders and other devices that can display, record or change the pressure in a closed loop system.

#### Product Features

- **Pressure Ranges:**
  - 1000 psig ( 6.9 MPa)
  - 1500 psig ( 10.3 MPa)
  - 2000 psig ( 13.8 MPa)
  - 3000 psig ( 20.7 MPa)
  - 5000 psig (34.5 MPa)
- **Superb Accuracy:**
  - $\pm 1.0\%$  overall full scale < 3000 at room temperature
  - $\pm 1.5\%$  overall full scale > 3000 at room temperature
  - includes Repeatability, Hysteresis and Linearity
- **Maximum Flexibility:** Custom ASIC provides signal conditioning for calibration and temperature compensation



*MediaSensor™ High Pressure Sensors with integrated signal conditioning (shown with various ports and connectors)*

- **Compact, Robust Package:** All laser-welded stainless steel design for optimal media isolation
- **Electrical Connectors:** Packard, Deutsch, MD-DIN, M12, Integral Harness
- **Electronics:**
  - 0.5 – 4.5 Volt output (with 5V input)
  - 0.5 – 4.5 Volt output with overvoltage protection (with 5V input)
  - 1 – 5 Volt Output (with 8 – 30V input)
  - 4-20 mA (with 8 – 30V input)
- **Standard and Custom Options**

Call us at **(888) 477-4320**

Or visit our

Web Site: <http://ssitechnologies.com>

# SSI Technologies – Application Note PS-AN14

## MediaSensor™ P51 Series HS

### High Pressure Sealed Gage Pressure Sensors

**Chemical Compatibilities:** Any gas or liquid compatible with 304L & 316L stainless steel.

- Refrigerant
- **Motor Oil**
- Diesel
- Hydraulic Fluid
- Brake Fluid
- **Water**
- **Waste Water**
- Hydrogen
- Nitrogen
- Air

### Typical Applications

- Refrigeration
- Fuel Cells
- Pumps
- Hydraulics
- Compressors
- Robotics
- Pneumatics
- Agriculture
- Spraying Systems
- Process Control
- Flow
- Hydrogen Storage

### Typical Connections

The following torque limits should be used when mounting the MediaSensor™ pressure port.

Straight Thread w/O-Ring:	Recommended Torque
High Pressure (> 750 PSI)	300 in lb
All others with out Port types T, U, Y	150 in lb
Parts with Ports T,U, Y	120 in lb

### MediaSensor™ Transmitter (4 -20mA) connections:

- 1) Connect the Power Lead (Red) to the + terminal of the supply voltage.
- 2) Connect the Return Lead (White) to the + terminal of the current measuring device
- 3) Connect the – terminal of the current measuring device to the – terminal of the supply voltage

### MediaSensor™ Transducer (Voltage Output) connections:

- 1) Connect the Power Lead (Red) to the + terminal of the supply voltage.
- 2) Connect the Ground Lead (Black) and the – terminal of the supply voltage to – input of your voltage measurement equipment.
- 3) Connect the Vout Lead (White) to the + input of your voltage measurement equipment.



# SSI Technologies – Application Note PS-AN14

## MediaSensor™ P51 Series HS

### High Pressure Sealed Gage Pressure Sensors

#### Packaging

MediaSensor™ is readily available in a large selection of standard packaging options. MediaSensor™ offers an integral harness with 6 standard lengths and four standard readily available connectors (Packard, Deutsch, M12 and Mini DIN). In addition, SSI will work with the customer to meet their needs with custom options for large volume orders. (I.e... special fittings & connectors; special pressure ranges; operating temperature; and increased accuracy).

**Integral Harness** (Standard lengths of 6", 12", 18", 24", 36" and 72"). The Harness can be constructed of either PVC Jacketed 18 or 24 AWG Wire.

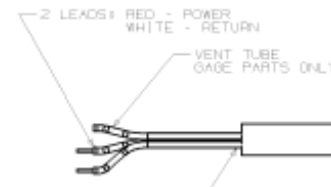

Wire Color  
Red - Power  
White - Return

#### Integral Harness Transmitter (4 to 20 mA)

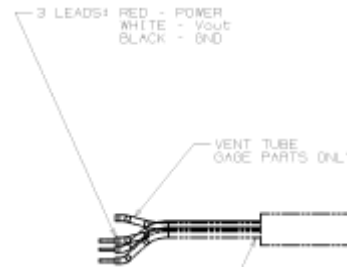

Wire Color  
Red - Power  
White - Vout  
Black - Ground

#### Integral Harness Transducer (1 to 5 Vdc or 0.5 to 4.5Vdc)

# SSI Technologies – Application Note PS-AN14

## MediaSensor™ P51 Series HS

### High Pressure Sealed Gage Pressure Sensors

#### Standard Connector Options

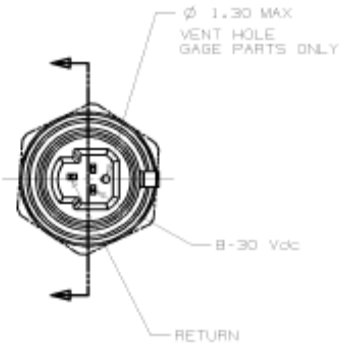

Pin 1 - Power  
 2 - Not Used  
 3 - Return

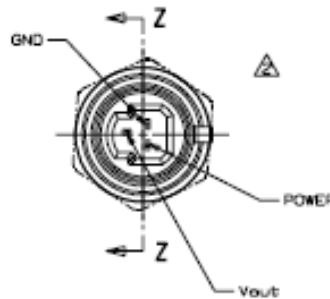

Pin 1 - Power  
 2 - Ground  
 3 - Vout

#### Packard Connector Transmitter (4 to 20 mA)

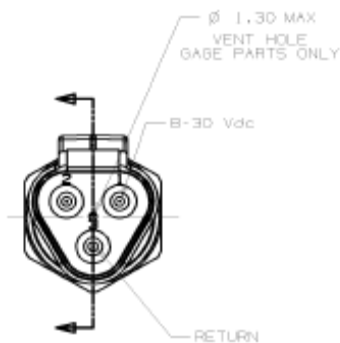

Pin 1 - Power  
 2 - Not Used  
 3 - Return

#### Deutsch Connector Transmitter (4 to 20 mA)

#### Packard Connector Transducer (1 to 5 Vdc or 0.5 to 4.5Vdc)

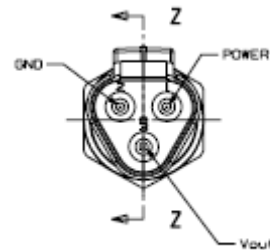

Pin 1 - Power  
 2 - Ground  
 3 - Vout

#### Deutsch Connector Transducer (1 to 5 Vdc or 0.5 to 4.5Vdc)



# SSI Technologies – Application Note PS-AN14 MediaSensor™ P51 Series HS High Pressure Sealed Gage Pressure Sensors

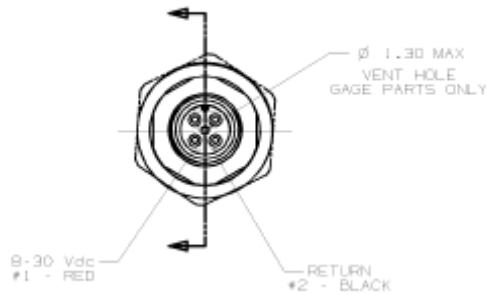

- Pin 1 - Power
- 2 - Return
- 3 - Not Used
- 4 - Not Used

## **M12 Connector Transmitter (4 to 20 mA)**

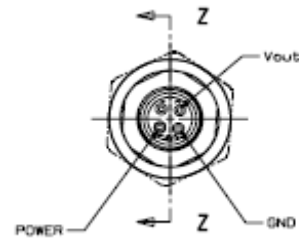

- Pin 1 - Power
- 2 - Ground
- 3 - Vout
- 4 - Not Used

## **M12 Connector Transducer (1 to 5 Vdc or 0.5 to 4.5Vdc)**

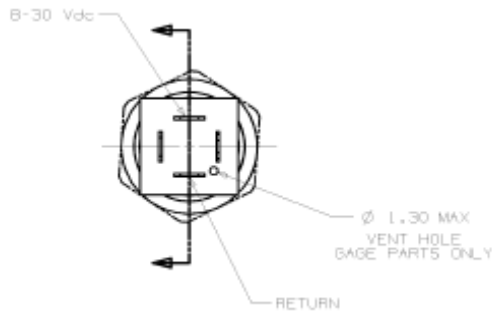

- Pin 1 - Power
- 2 - Return
- 3 - Not Used
- 4 - Not Used

## **DIN 43650 Transmitter Connector**

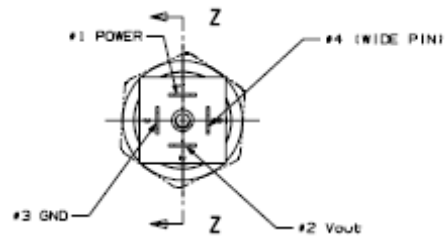

- Pin 1 - Power
- 2 - Vout
- 3 - Ground
- 4 - Not Used

## **DIN 43650 Transducer Connector**

# SSI Technologies – Application Note PS-AN14 MediaSensor™ P51 Series HS High Pressure Sealed Gage Pressure Sensors

## Standard Packaging Options

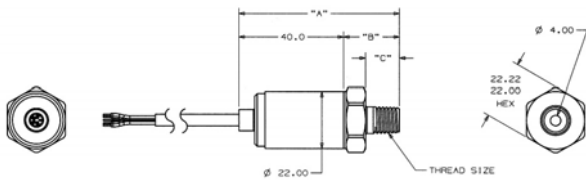

THREAD SIZE	LENGTH "A"	LENGTH "B"	LENGTH "C"
1/4-18 NPT	66.6	26.0	18.0
1/8-27NPT	61.6	21.0	13.0
7/16-20UNF	59.6	19.0	11.0
9/19-18 UNF	59.6	19.0	11.0
3/8-24 UNF	58.1	17.5	9.5

### Integral Harness with 22mm Hex

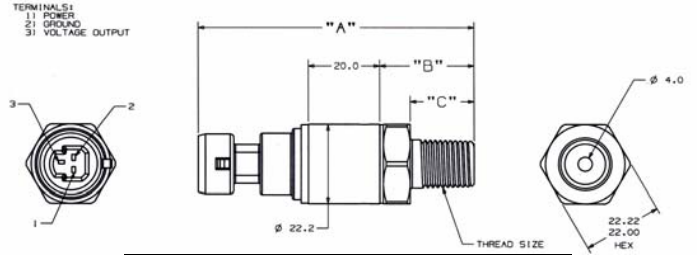

THREAD SIZE	LENGTH "A"	LENGTH "B"	LENGTH "C"
1/4-18 NPT	70.0	26.0	18.0
1/8-27NPT	65.0	21.0	13.0
7/16-20UNF	63.0	19.0	11.0
9/19-18 UNF	63.0	19.0	11.0
3/8-24 UNF	61.5	17.5	9.5

### Packard Connector with 22mm Hex

5 Vdc Input: 0.5 – 4.5 Vdc Ratiometric Output

Harness Construction: PVC Jacketed 24 AWG Wire

Mating Packard Connector P/N 12065287 and Mating Packard Terminal P/N 12103881

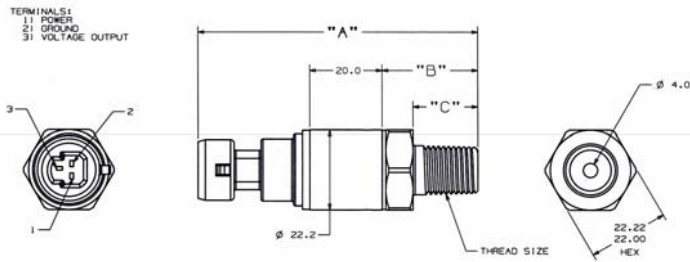

THREAD SIZE	LENGTH "A"	LENGTH "B"	LENGTH "C"
1/4-18 NPT	70.0	26.0	18.0
1/8-27NPT	65.0	21.0	13.0
7/16-20UNF	63.0	19.0	11.0
9/19-18 UNF	63.0	19.0	11.0
3/8-24 UNF	61.5	17.5	9.5

### Packard Connector with 22mm Hex

8 - 30 Vdc Input : 1 - 5 Vdc Output

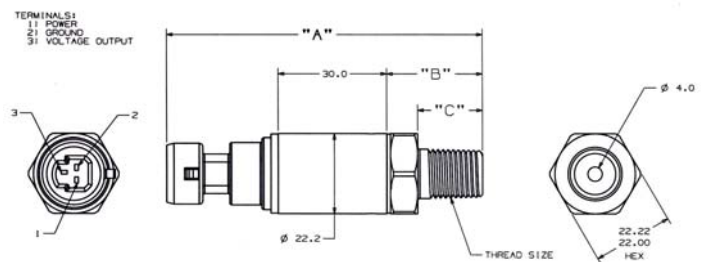

THREAD SIZE	LENGTH "A"	LENGTH "B"	LENGTH "C"
1/4-18 NPT	80.0	26.0	18.0
1/8-27NPT	75.0	21.0	13.0
7/16-20UNF	73.0	19.0	11.0
9/19-18 UNF	73.0	19.0	11.0
3/8-24 UNF	71.5	17.5	9.5

### Packard Connector with 22mm Hex

8 - 30 Vdc Input : 4 - 20 mA Output

Mating Packard Connector P/N 12065287 and Mating Packard Terminal P/N 12103881

# SSI Technologies – Application Note PS-AN14

## MediaSensor™ P51 Series HS

### High Pressure Sealed Gage Pressure Sensors

**Typical Performance Specifications** (all values at 22°C unless noted otherwise)

Output Type	0.5 to 4.5 Volts	4 – 20 mA	1 – 5 Volts
Accuracy <sup>1</sup> (1000 PSI TO 5000 PSI)	<± 1.00% FS	<± 1.00% FS	<± 1.00% FS
Thermal Error <sup>2</sup> (-40°C to 105°C)	<± 1.00% FS	<± 1.00% FS	<± 1.00% FS
Zero Pressure Offset <sup>3</sup>	0.50 V	4.0 mA	1.0 V
Full Scale Output <sup>4</sup>	4.5 V	20 mA	5.0 V
Operating Temperature	-40 to 105°C	-40 to 105°C	-40 to 105°C
Storage Temperature	-40 to 105°C	-40 to 105°C	-40 to 105°C
Proof Pressure	3 X FS	3 X FS	3 X FS
Burst Pressure Gage Pressure Transducers	10 X FS or 20,000 PSI (whichever is less)	10 X FS or 20,000 PSI (whichever is less)	10 X FS or 20,000 PSI (whichever is less)
Reverse Voltage Protection (+/- 16V over 5 minutes)	N/A	Reverse	Reverse
Overvoltage Protection Option (+/- 16V over 5 minutes)	Available	N/A	N/A

#### Electrical Specifications

Output Type	0.5 to 4.5 Volts	4 – 20 mA	1 – 5 Volts
Supply Voltage	5 +/- 0.5	8 to 30 Volts	8 to 30 Volts
Supply Current	< 3 mA	Not Applicable	< 5 mA
Output Current	0.45mA Max (Sink or Source)	Not Applicable	0.45mA Max (Sink or Source)
Response Time	< 1 ms	< 1 ms	< 1ms

#### Reliability and Environmental Performance

	Test Conditions	Value	Units
Pressure/Temperature Cycles <sup>5</sup>	0 to 3000 PSI @ 8Hz; and -40°C to 105°C	>6 million	Cycles
Thermal Shock	105°C to -40°C, 0.5 hr soaks at Temp. (2s Transfer)	300	Cycles
Vibration	100 to 2000 Hz, 20g Sinusoidal, 3 Axes	144	Hours
EMC Compatibility <sup>6</sup>	EN 61000-4-3	10	Volts/meter
Humidity	85°C at 85% R. H.	250	Hours
Weight	Model 51 with M12 x 1.5 6g 304L Stainless Port	≤85	Grams

<sup>1</sup>Includes hysteresis, repeatability, & non-linearity (BFSL)

<sup>2</sup>Additional over temperature

<sup>3</sup>Transducer output @ 0 PSIA, 0 PSIG, or 0 PSIS (consult factory for other options)

<sup>4</sup>Sealed Transducer output @ Pressure Range + 14.5 PSIA

<sup>5</sup>Pressure cycling performed at rated full scale pressure.

<sup>6</sup>Higher levels of EMC Compatibility are available upon request.





# SSI Technologies – Application Note PS-AN14

## MediaSensor™ P51 Series HS

### High Pressure Sealed Gage Pressure Sensors

#### MediaSensor™ Series HS Sealed Gauge Pressure Sensors Ordering System

The following explains SSI's pressure transducer order number sequence.

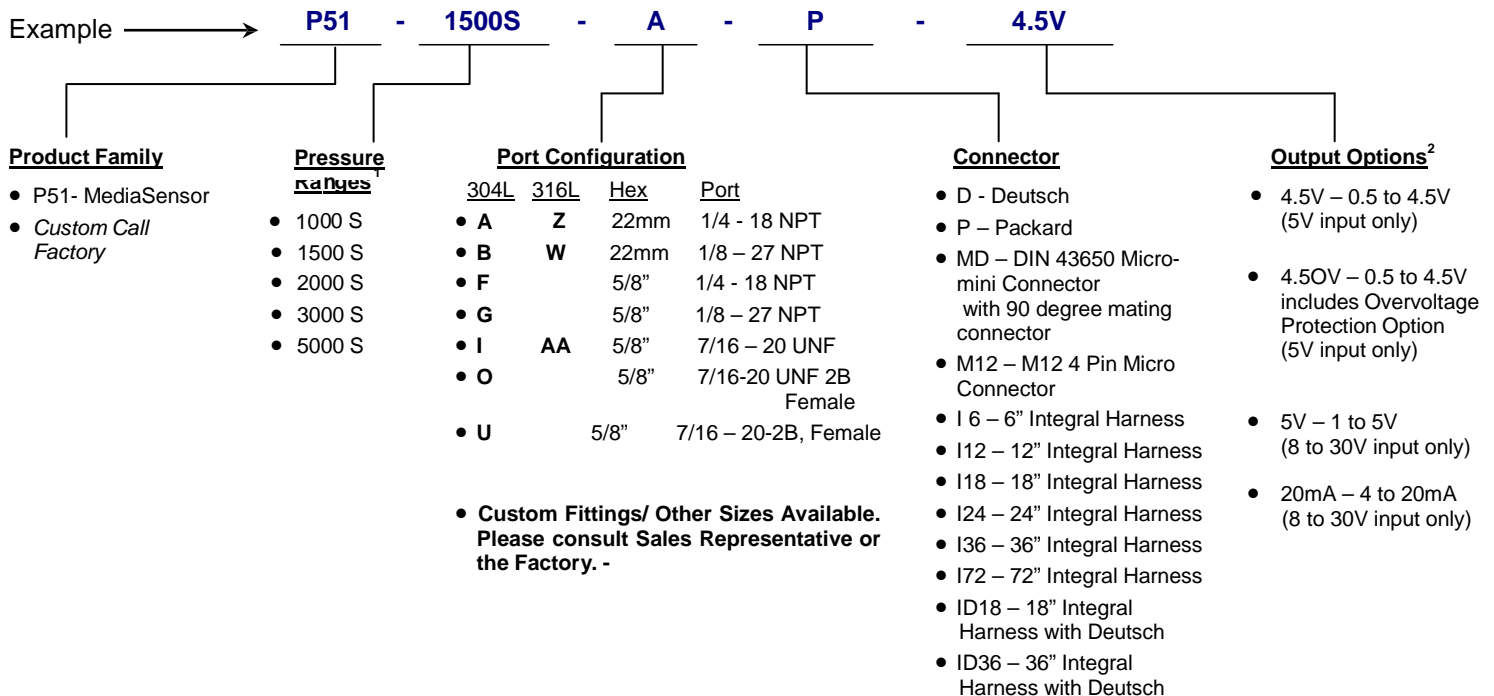

- Notes:**
- 1) S designates Sealed Gage Pressure
  - 2) Calibration of the transducer is as follows: Sealed Gage Transducers are calibrated to have 0.5 Vdc, 1 Vdc, or 4 mA respectively at 14.5 PSIG
  - 3) Sealed Gauge Transducers are not vented to atmosphere, but are calibrated to resemble a gauge transducer output per the above note.

To place an order or to view our other pressure sensors, please see our website <http://www.ssitechnologies.com> for a listing of our distribution partners and Regional Sales Managers.

For custom orders or specifications not listed, call SSI toll-free at **1- 888- 477- 4320**