



VQ5 Series Thermal Conductivity Gas Detector Elements

To be read in conjunction with "Introduction to Pellistor Gas Sensors" and Pellistor Application Note 5 - Thermal Conductivity Sensors.

INTRODUCTION

The VQ5 series devices consist of two matched elements which are used for the detection of gases in 0 - 100% by volume concentrations using the recommended bridge circuit (see below) and the mounting arrangement shown on page 3. The VQ5M is supplied with braided leads and the VQ5MB has extended pins for fitting directly to printed circuit boards.

The elements operate on the thermal conductivity principle. The sensing element is open to the atmosphere under test and the reference element is supplied sealed in reference air. The response of the devices is dependent upon the difference between the thermal conductivity of the atmosphere under test and the reference air. When the atmosphere under test has a thermal conductivity higher than the reference air, the sensing element loses more heat to the surroundings than the reference element. This increased heat loss causes a cooling of the sensing element and a subsequent reduction in the resistance of the sensing element compared to the reference element.

The thermal conductivity of a gas mixture is dependent on temperature and the individual thermal conductivity of the constituents of the mixture. The temperature of importance is the operating temperature of the sensing element (typically a maximum of 500 °C at the recommended bridge supply voltage). The sensor can be operated at any bridge voltage up to and including the recommended bridge supply, with the sensing element therefore running at temperatures up to and including the typical maximum. The thermal conductivity of some of the more common gases relative to air is tabulated on page 2 at various temperatures. **Note that when operating the sensor in a constant voltage mode the response will be non-linear to increasing concentrations of a gas.**

GENERAL DATA

Electrical

The information given below relates to the VQ5 series operating in the recommended circuit shown.

Operation (see note 1) continuous
 Bridge supply 2.0 ± 0.1 V
 Bridge power consumption 0.48 W max
 Typical response to methane in air
 (see note 2) 1.0 mV/% methane
 Response time see note 3

Mechanical

Mounting see page 3
 Outlines see page 2
 Shock test 250 g, 5 blows in each plane
 Vibration test 20 g, 24 cycles from 100 to 3200 Hz

BRIDGE CIRCUIT

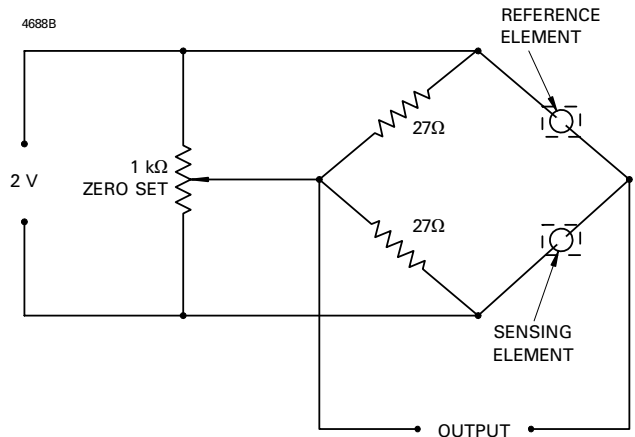

MARKING

Each element is identified by a unique serial number written on the can of both the sensing and reference elements. The serial number is written in red on the sensing element and black on the reference element. In addition, the sensing element carries a red circular label on the base identifying the device type.

NOTES

1. Operation may be under either direct flow or diffusion conditions in appropriate mountings (see page 3).
2. With open-circuit conditions at the bridge output.
3. The response time is a function of the type of mounting used.

ORDERING INFORMATION

Order Code	Description
VQ5	Flexi-leg sensor with open compensator can. This device needs to have the compensator mounted in a sealed chamber filled with air or nitrogen.
VQ5B	PCB legged sensor with open compensator can. This device needs to have the compensator mounted in a sealed chamber filled with air or nitrogen.
VQ5M	Flexi-leg sensor with sealed compensator can.
VQ5MB	PCB legged sensor with sealed compensator can.

THERMAL CONDUCTIVITY OF GASES (Relative to air)

Element temperature	0 °C	100 °C	200 °C	300 °C	400 °C	500 °C	600 °C
Air	1.000	1.000	1.000	1.000	1.000	1.000	1.000
Nitrogen	0.996	0.993	0.997	0.999	0.998	0.994	0.988
Oxygen	0.987	1.026	1.049	1.062	1.065	1.062	1.056
Argon	0.686	0.687	0.682	0.674	0.663	0.650	0.636
Carbon dioxide	0.621	0.745	0.832	0.893	0.933	0.959	0.975
Water vapour	0.969	1.076	1.192	1.303	1.404	1.493	1.574
Methane	1.244	1.500	1.723	1.911	2.066	2.192	2.296
Ethane	0.742	1.027	1.271	1.474	1.638	1.769	1.874
Propane	0.619	0.874	1.092	1.271	1.415	1.529	1.619
Carbon monoxide	0.961	0.962	0.970	0.975	0.976	0.974	0.970
Ethylene	0.703	0.970	1.195	1.378	1.524	1.637	1.727
Acetylene	0.886	1.040	1.155	1.240	1.301	1.344	1.376
Hydrogen	7.371	6.918	6.692	6.548	6.435	6.336	6.252
Helium	5.972	5.681	5.492	5.338	5.197	5.062	4.939
Ammonia	1.082	1.295	1.493	1.670	1.824	1.955	2.069

OUTLINE OF VQ5M (All dimensions without limits are nominal)

2311B

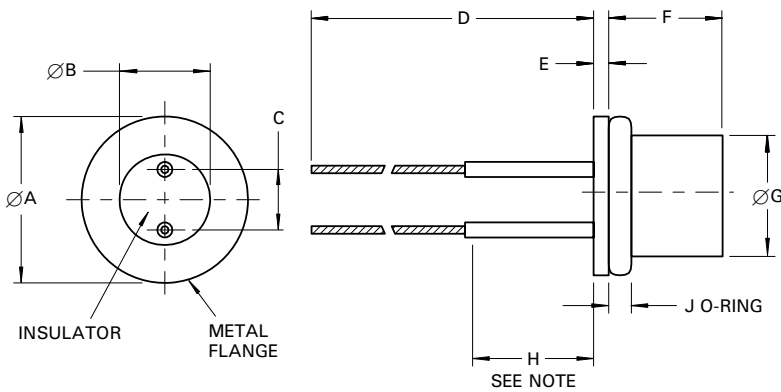

Ref	Millimetres
A	11.05 ± 0.25
B	6.10 ± 0.25
C	3.56 ± 0.13
D	63.5 min
E	1.0
F	*
G	8.2 max
H	9.53
J	1.5

* sensing element 6.25 ± 0.50
reference element 7.75 ± 0.38

Note No bends may be made in this length.

OUTLINE OF VQ5MB (All dimensions without limits are nominal)

7218

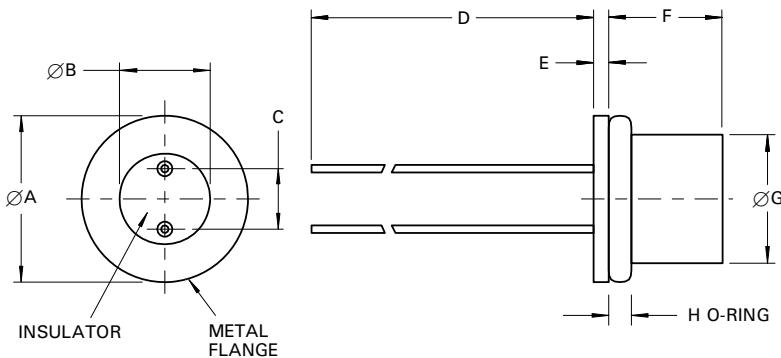

Ref	Millimetres
A	11.05 ± 0.25
B	6.10 ± 0.25
C	3.56 ± 0.13
D	40.0 min
E	1.0
F	*
G	8.2 max
H	1.5

* sensing element 6.25 ± 0.50
reference element 7.75 ± 0.38

RECOMMENDED MOUNTING ARRANGEMENTS

4689A

SENSING ELEMENT
EXPOSED TO GAS UNDER TEST

REFERENCE ELEMENT
SEALED OFF FROM GAS UNDER TEST

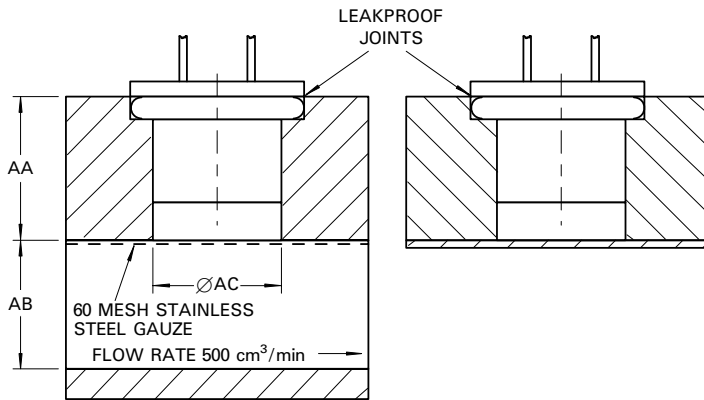

Ref	Millimetres
AA	9.53 ± 0.13
AB	8.33 ± 0.13
AC	8.20 min
AD	9.53 ± 0.13
AE	8.20 min

