

Power Solid State Relays

G3PA

Long Service Life for Circuits that Cycle Frequently

- Built-in heat sink increases life and reliability
- Voltage turn-on at zero crossing reduces initial inrush load currents
- LED indicator turns on when control power is applied
- DIN rail mountable
- Conforms to UL, CSA, VDE and CE requirements



Ordering Information

■ G3PA RELAYS WITH REPLACEABLE TRIAC OUTPUT CARTRIDGE

- Current indicator turns red when excessive current is applied
- Side-by-side dense mounting is possible using built-in linking brackets

24-240 VAC Models

Max. load current	Max. inrush current	Operating voltage	Load voltage	Part number
10 amps	150 amps, 60 Hz	5-24 VDC	24-240 VAC	G3PA-210B-VD DC5-24
20 amps	220 amps, 60 Hz			G3PA-220B-VD DC5-24
40 amps	440 amps, 60 Hz			G3PA-240B-VD DC5-24
60 amps	440 amps, 60 Hz			G3PA-260B-VD DC5-24

200-480 VAC Models

Max. load current	Max. inrush current	Operating voltage	Load voltage	Part number
20 amps	220 amps, 60 Hz	12-24 VDC	200-480 VAC	G3PA-420B-VD-2 DC12-24
30 amps	440 amps, 60 Hz			G3PA-430B-VD-2 DC12-24
50 amps	440 amps, 60 Hz			G3PA-450B-VD-2 DC12-24

■ DIN RAIL MOUNTING TRACK

Description	Part number
DIN rail track, 7.3 mm (0.29 in) depth; 50 cm (1.64 ft) length	PFP-50N
DIN rail track, 7.3 mm (0.29 in) depth; 1 m (3.28 ft) length	PFP-100N
End plate	PFP-M
Spacer	PFP-S

Application Example

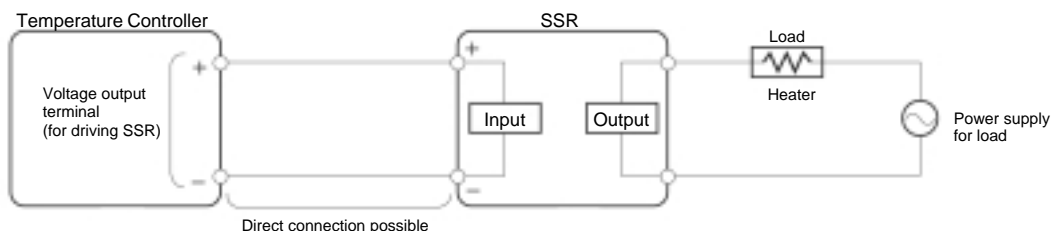

Omron's SSRs offer these advantages over electro-mechanical relays (EMRs):

- Longer service life with no contacts to wear out
- Reduced electromagnetic interference
- Faster response time
- Vibration and shock resistance
- No audible noise when switching
- Enhanced reliability

Specifications

■ RATINGS

Input (at 25°C)

Model	Rated voltage	Voltage range	Input current impedance	Voltage level	
				Must operate voltage	Must release voltage
G3PA-210B-VD	5 to 24 VDC	4 to 30 VDC	7 mA max.	4 VDC max.	1 VDC min.
G3PA-220B-VD					
G3PA-240B-VD					
G3PA-260B-VD					
G3PA-420B-VD-2	12 to 24 VDC	9.6 to 30 VDC	7 mA max.	9.6 VDC max.	1 VDC min.
G3PA-430B-VD-2					
G3PA-450B-VD-2					

Output

Model	Applicable load			
	Load voltage	Load current	Inrush current	With Class-1 AC resistive load
G3PA-210B-VD	19 to 264 VAC (50/60 Hz)	0.1 to 10 A	150 A (60 Hz, 1 cycle)	2.4 kW at 240 VAC
G3PA-220B-VD		0.1 to 20 A	220 A (60 Hz, 1 cycle)	4.8 kW at 240 VAC
G3PA-240B-VD		0.5 to 40 A	440 A (60 Hz, 1 cycle)	9.6 kW at 240 VAC
G3PA-260B-VD		0.5 to 60 A	440 A (60 Hz, 1 cycle)	14.4 kW at 240 VAC
G3PA-420B-VD-2	180 to 528 VAC (50/60 Hz)	0.5 to 20 A	220 A (60 Hz, 1 cycle)	9.6 kW at 480 VAC
G3PA-430B-VD-2		0.5 to 30 A	440 A (60 Hz, 1 cycle)	14.4 kW at 480 VAC
G3PA-450B-VD-2		0.5 to 50 A	440 A (60 Hz, 1 cycle)	24 kW at 480 VAC

■ CHARACTERISTICS

G3PA

Item	G3PA-210B-VD	G3PA-220B-VD	G3PA-240B-VD	G3PA-260B-VD	G3PA-420B-VD-2	G3PA-430B-VD-2	G3PA-450B-VD-2
Operate time	1/2 of load power source cycle + 1 ms max. (DC Input, -B models) 1 1/2 of load power source cycle + 1 ms max. (AC Input)						
Release time	1/2 of load power source cycle + 1 ms max. (DC Input) 1 1/2 of load power source cycle + 1 ms max. (AC Input)						
Output ON voltage drop	1.6 V (RMS) max.				1.8 V (RMS) max.		
Leakage current	5 mA max. at 120 VAC 10 mA max. at 230 VAC		10 mA max. at 120 VAC 20 mA max. at 230 VAC		20 mA max. at 400 VAC		
I ² t	260 A ² S		810 A ² S		260 A ² S		810 A ² S
Insulation resistance	100 MΩ min. at 500 VDC						
Dielectric strength	4,000 VAC, 50/60 Hz for 1 min						
Vibration resistance	Malfunction: 10 to 55 Hz, 0.75-mm double amplitude (mounted to DIN rail)						
Shock resistance	Malfunction: 300 m/s ² (mounted to DIN rail)						
Ambient temperature	Operating: -30°C to 80°C (with no icing or condensation) Storage: -30°C to 100°C (with no icing or condensation)						
Approved standards	UL508 File No.E64562, CSA C22.2 (No.14, No.950) File No.LR35535, EN60950 File No. 5915UG						
Ambient humidity	Operating: 45% to 85%						
Weight	Approx. 260 g	Approx. 340 g	Approx. 460 g	Approx. 900 g	Approx. 290 g	Approx. 410 g	Approx. 900 g

Dimensions

Unit: mm (inch)

SOLID STATE RELAYS WITH BUILT-IN HEAT SINKS

G3PA-210B-VD

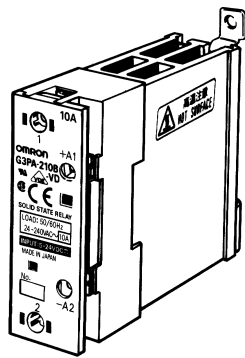

Without Terminal Cover

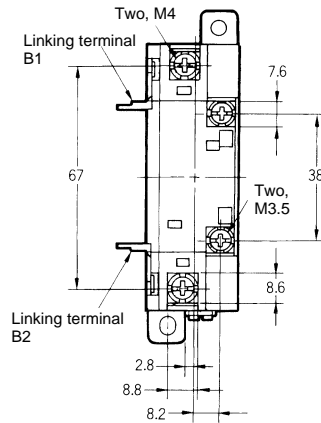

With Terminal Cover

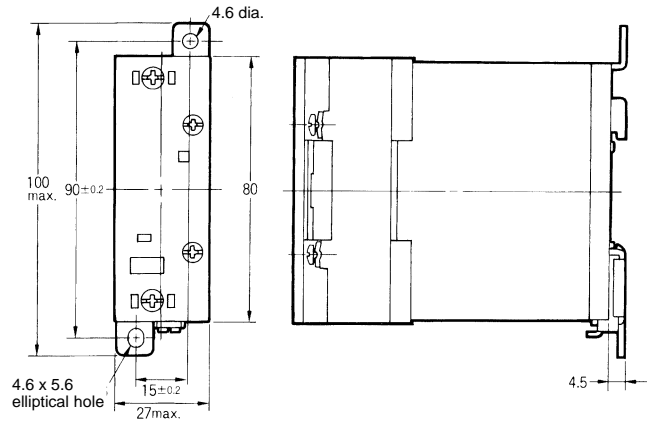

Mounting Holes

Two, 4.5 dia. or M4 holes

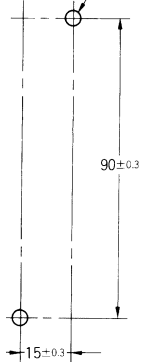

Terminal Arrangement/
Internal Connections

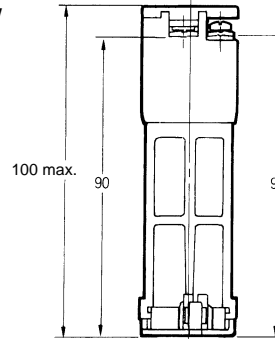
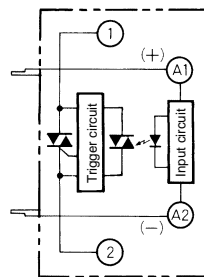

G3PA-220B-VD

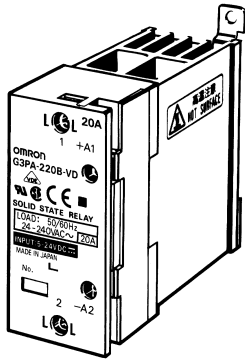

Without Terminal Cover

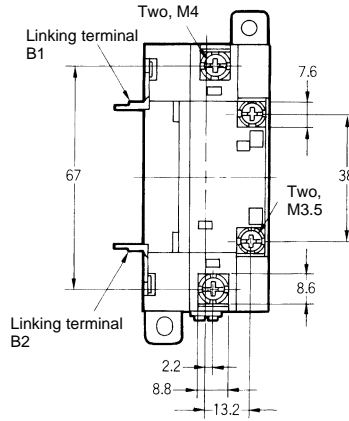

With Terminal Cover

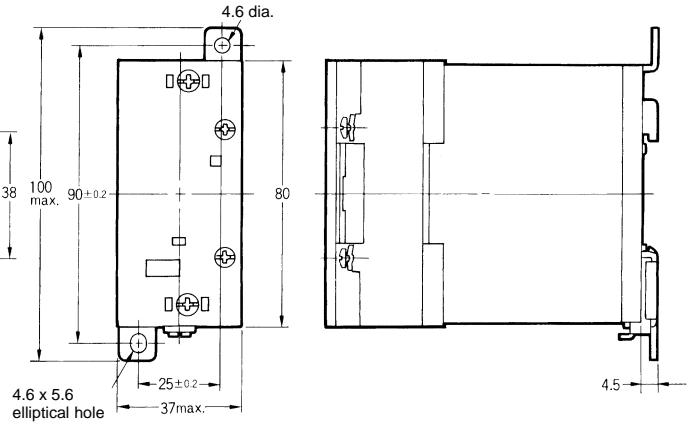

Mounting Holes

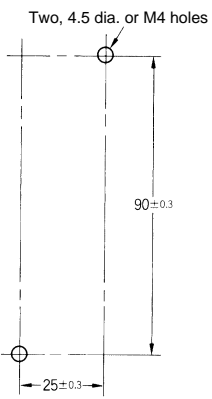

Terminal Arrangement/ Internal Connections

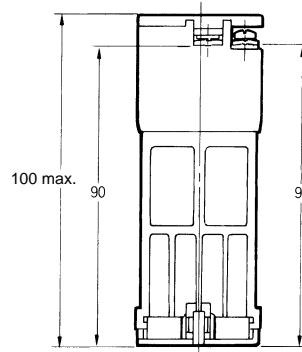
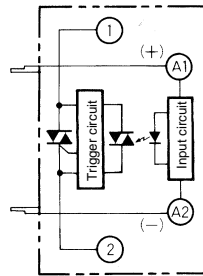

G3PA-240B-VD

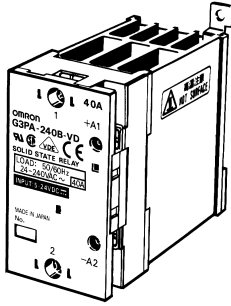

Without Terminal Cover

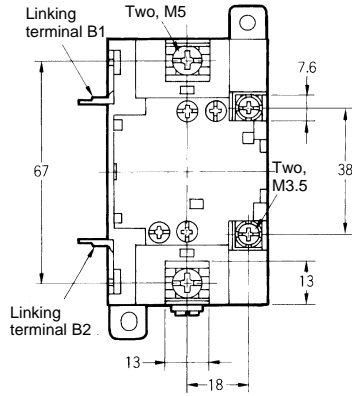

With Terminal Cover

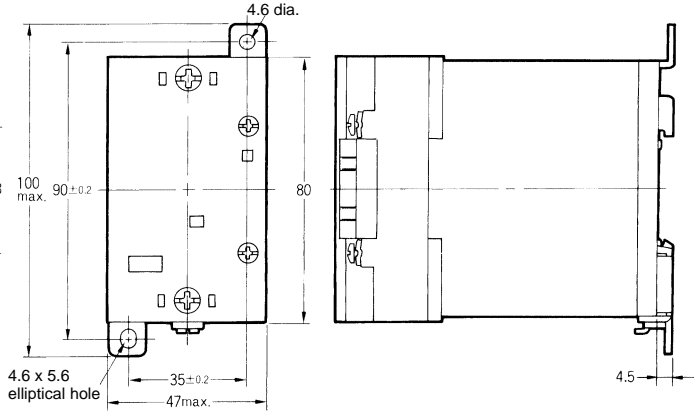

Mounting Holes

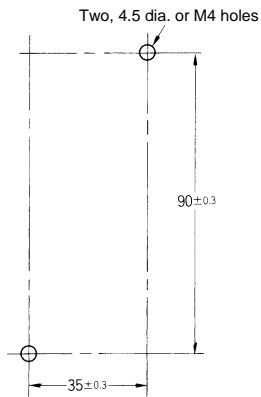

**Terminal Arrangement/
Internal Connections**

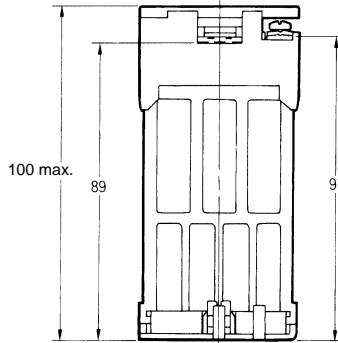
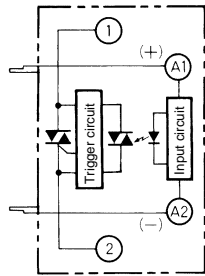

G3PA-260B-VD
G3PA-450B-VD-2

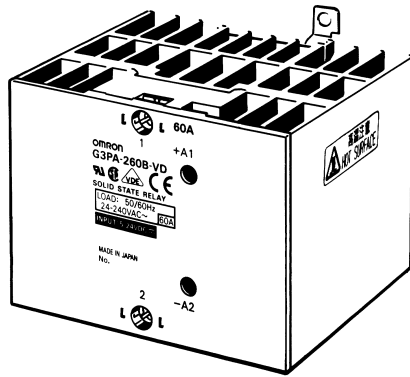

Without Terminal Cover

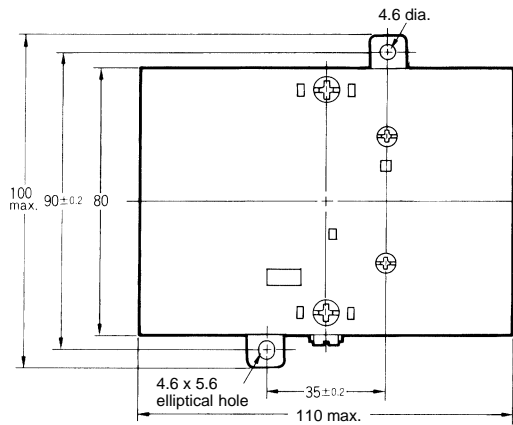

With Terminal Cover

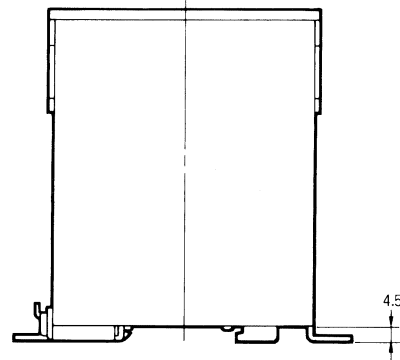
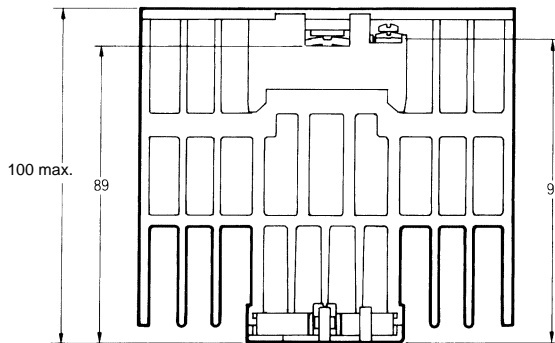
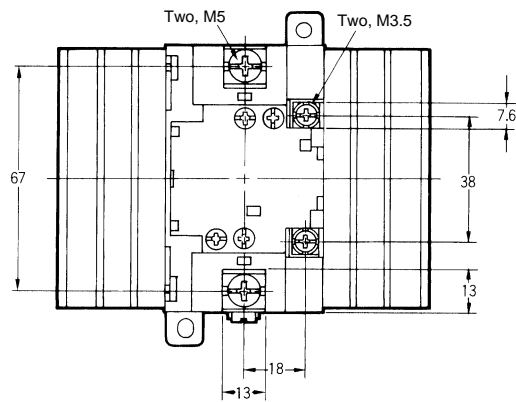

Mounting Holes

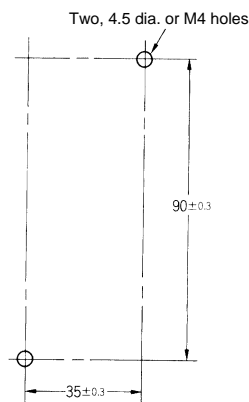

Terminal Arrangement/
Internal Connections

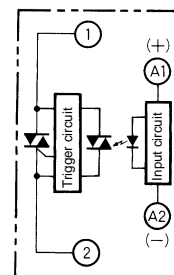

G3PA-420B-VD-2

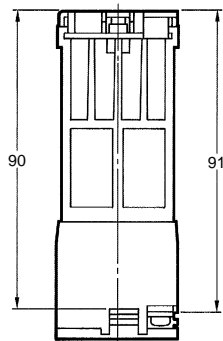
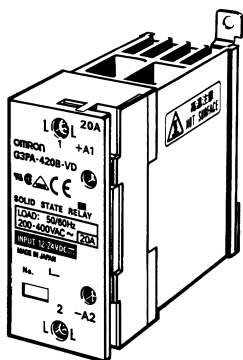

**Terminal Arrangement/
Internal Connections**

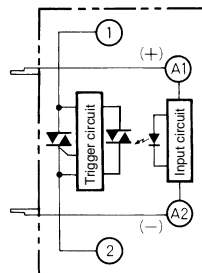

Mounting Holes

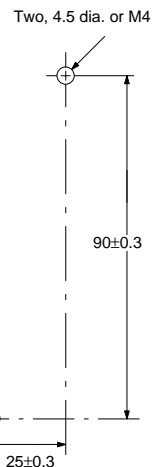
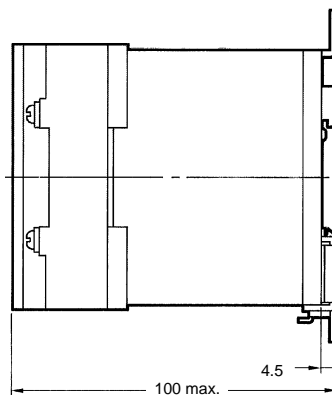
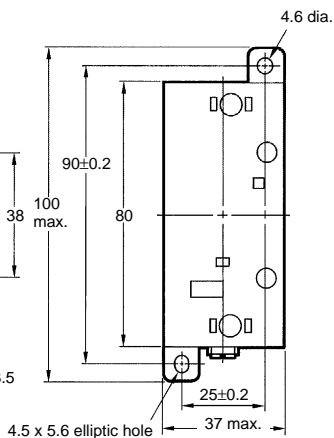
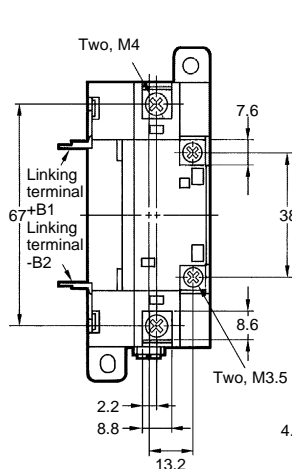

G3PA-430B-VD-2

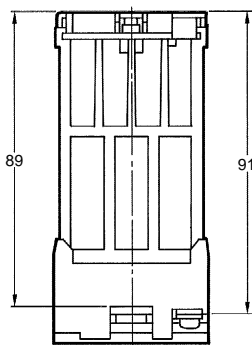
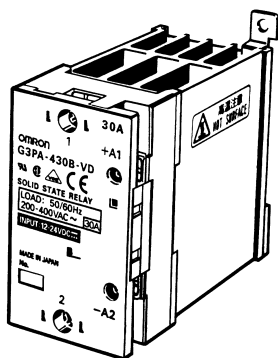

**Terminal Arrangement/
Internal Connections**

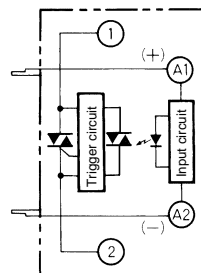

Mounting Holes

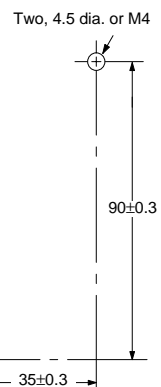
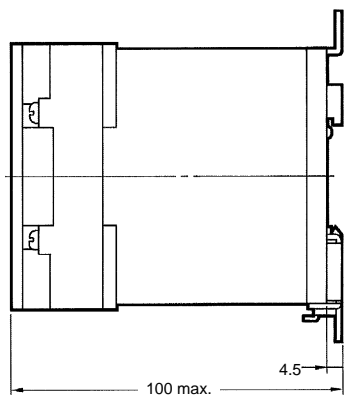
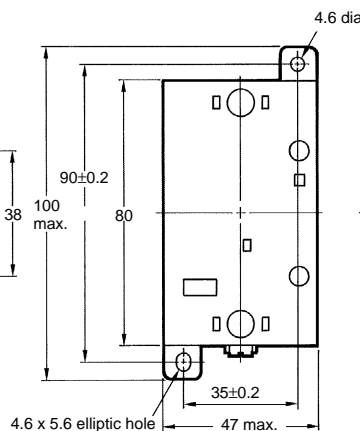
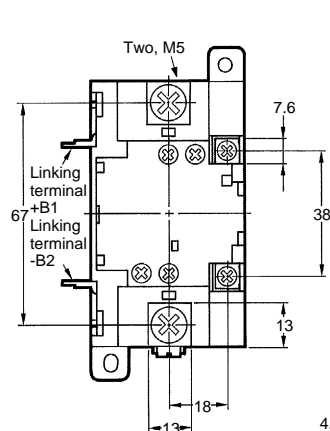

Precautions

! WARNING

Do not touch the terminals (i.e., charged parts) of the G3PB while power is supplied, otherwise an electric shock may be received.

If the G3PB is provided with a terminal cover, be sure to attach the terminal cover to the G3PB before operating the G3PB.

The G3PB and radiator are very hot while power is supplied to the G3PB.

Do not touch the G3PB or the radiator while power is supplied to the G3PB or immediately after the G3PB is turned OFF, otherwise a burn may result.

Do not touch the load terminal of the G3PB immediately after the G3PB is turned OFF, otherwise an electric shock may be received due to the residual charge of the built-in snubber circuit.

Be sure to turn OFF the power supply to the G3PB before wiring, otherwise an electric shock may be received.

Mount the terminal cover to the G3PB after wiring.

Do not touch the terminals of the G3PB while power is supplied, otherwise an electric shock may be received.

The built-in capacitor will be charged as long as power is supplied. Do not touch the terminals of the G3PB unless the G3PB is turned OFF and the built-in capacitor discharges all of its residual voltage, otherwise an electric shock may result.

! Caution

Do not apply excessive voltage or current to the input or output circuit of the G3PB, otherwise the G3PB may malfunction or burn.

Do not use the G3PB unless all the output terminal screws are tightened securely, otherwise the terminals may generate excessive heat and the G3PB may burn.

Be sure to provide enough ventilation to the G3PB and the radiator, otherwise the G3PB may generate excessive heat and the G3PB may burn or the output element may short-circuit.

Be sure to turn OFF the power supply to the G3PB before wiring, otherwise an electric shock may be received.

Be sure to wire or solder the terminals of the G3PB properly, otherwise the G3PB may generate excessive heat and burn.

If the G3PB is mounted directly to a control panel that is used as a radiator as well, the control panel must be made of aluminum or a steel plate with low thermal resistance.

Do not use any material with high thermal resistance, such as a wooden plate, otherwise the G3PB may catch on fire or burn.

BEFORE ACTUAL OPERATION

- The G3PB in operation may cause an unexpected accident. Therefore it is necessary to test the G3PB under a variety of conditions that are possible. As for the characteristics of the G3PB, it is necessary to take into consideration the dispersion of the characteristics between G3PB Units.
- The ratings in this datasheet are tested values in a temperature range between 15°C and 30°C, a relative humidity range between 25% and 85%, and an atmospheric pressure range between 88 and 106 kPa. It will be necessary to provide the above conditions as well as the load conditions if the user wants to confirm the ratings of actual G3PB Units.

MOUNTING METHOD

Since the Relay is heavy, firmly mount the DIN track and fix both ends with End Plates for DIN-track-mounting models. For direct mounting, firmly mount the Relay on the panel.

Vertical Mounting

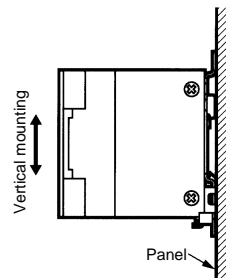

Horizontal Mounting

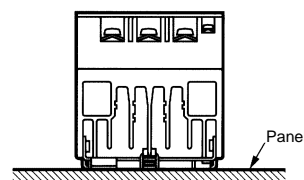

Note: Make sure that the load current is 50% of the rated load current when the G3PB is mounted horizontally.

Close Mounting

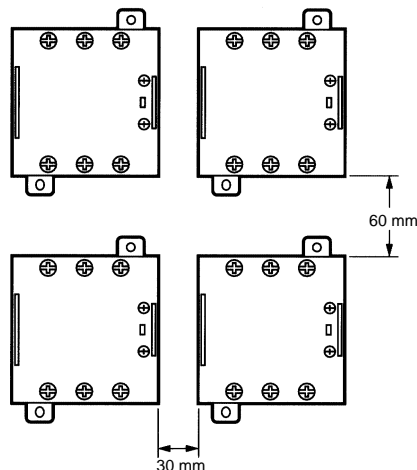

Note: Be sure to provide a minimum space of 30 mm horizontally and 60 mm vertically between adjacent Units.

■ WIRING

When using crimp terminals, refer to the terminal clearances shown below.

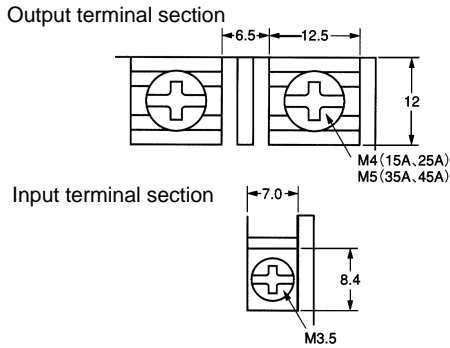

Be sure that all lead wires are thick enough according to the current.

Output terminals T1, T2, and T3 are charged regardless of whether the Unit is a 2- or 3-element model that is turned on or off. Do not touch these terminals, otherwise an electric shock may be received.

To isolate the Unit from the power supply, install an appropriate circuit breaker between the power supply and Unit.

Be sure to turn off the power supply before wiring the Unit.

Terminal L2 and terminal T2 of the 2-element model are internally short-circuited to each other. Therefore, connect terminal L2 to the ground terminal of the power supply. If terminal L2 is connected to a terminal other than the ground terminal, cover all the charged terminals, such as heater terminals, for the prevention of electric shock accidents and ground faults.

■ TIGHTENING TORQUE

Refer to the following and be sure to tighten each screw of the Unit to the specified torque in order to prevent the Unit from malfunctioning.

Item	Screw terminal diameter	Tightening torque
Input terminal	M3.5	0.8 N • m
Output terminal	M4	1.2 N • m
	M5	2.0 N • m

■ MOUNTING MODELS WITHOUT BUILT-IN HEAT SINK

Before attaching an external radiator or Heat Sink to the Unit, be sure to apply silicone grease for heat radiation, such as Toshiba's YG6260 or Sinetsu Silicone's G746, to the surface where the radiator or Heat Sink is attached.

Be sure to apply the following torque to secure the Unit and external radiator or Heat Sink for proper heat radiation.

Tightening torque: 2.0 N • m

■ OPERATING CONDITIONS

Do not apply current exceeding the rated current. Otherwise the temperature of the Unit may rise excessively.

Be sure to prevent ambient temperature rising due to the heat radiation of the Unit. In the case of enclosed mounting, install a fan so that the interior of the panel can be fully ventilated.

■ OPERATING AND STORAGE ENVIRONMENTS

Do not use or store the Unit in the following places, otherwise the Unit may malfunction or the characteristics of the Unit may deteriorate.

- Locations subject to direct sunlight.
- Locations subject to ambient operating temperatures outside the range of -30°C to 80°C .
- Locations subject to ambient operating humidity outside the range of 45% to 85%.
- Locations subject to condensation as the result of severe changes in temperature.
- Locations subject to ambient storage temperatures outside the range of -30°C to 100°C .
- Locations subject to corrosive or flammable gases.
- Locations subject to dust (especially iron dust) or salts.
- Locations subject to shock or vibration.
- Locations subject to exposure to water, oil, or chemicals.

OMRON[®]

OMRON ELECTRONICS, INC.

One East Commerce Drive
Schaumburg, IL 60173

1-800-55-OMRON

OMRON CANADA, INC.

885 Milner Avenue
Scarborough, Ontario M1B 5V8

416-286-6465

Specifications subject to change without notice.