

# MS761

# PRESSURE SENSOR DIE (0-1 BAR)

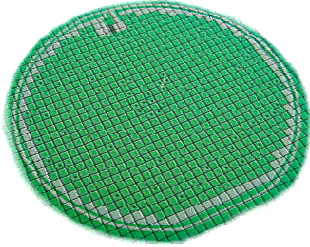

- 0 to 100 kPa range (1 bar or 14.5 PSI)
- Absolute/differential pressure sensors
- High Sensitivity
- RoHS-compatible & Pb-free<sup>1</sup>

## DESCRIPTION

The sensor element of the MS761 consists of a silicon micro-machined membrane. Implanted resistors make use of the piezo-resistive effect to sense the membrane deflection and transform it in an electrical signal. This sensor, which has outstanding span values, is available in various configurations. The absolute pressure sensor employs a sealed vacuum reference cavity underneath the membrane. The Pyrex glass wafer used for this sealing has a thickness of 0.2 mm (MS761-A\_0.2) or 0.5 mm (MS761-A\_0.5). There are two gauge versions available: one with a drilled Pyrex glass (MS761-D) and the other without Pyrex glass (MS761-S).

## FEATURES

- Uncompensated pressure sensor die
- Output Span 240 mV @ 5V
- Temperature Range -40°...+125°C
- Linearity 0.15% (typical)
- Small Die Size 1.96 x 2.10 mm (MS761-A)
- Low Cost, High reliability

## APPLICATION

- For high resolution absolute sensor systems
- Absolute/Differential pressure sensor systems
- Barometers, Altimeters, Variometers
- Engine Controls

## ELECTRICAL CONNECTIONS

Positive output for pressure applied topside

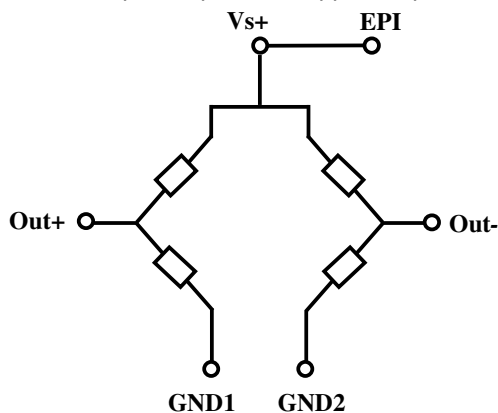

- Vs+ : Supply voltage of Wheatstone bridge
- Epi : Connection of epitaxial layer (membrane)
- Out- : Negative output
- Out+ : Positive output
- GND1 : Ground
- GND2 : Ground

<sup>1</sup> The European RoHS directive 2002/95/EC (Restriction of the use of certain Hazardous Substances in electrical and electronic equipment) bans the use of lead, mercury, cadmium, hexavalent chromium and polybrominated biphenyls (PBB) or polybrominated diphenyl ethers (PBDE).

## BOND PAD CONFIGURATION

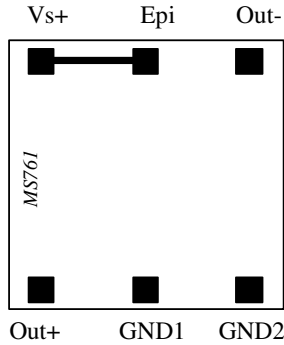

### Important remarks:

As the sensing elements are diffused resistances, the voltage applied on the ground pads (GND1 and GND2) has to be lower than the voltage applied on supply voltage pad (Vs+).

The epitaxial layer is connected to the Vs+ pin on the die

Gold ball bonding or aluminium wedge bonding can be used to wire-bond the sensor. The quality of the wire-bonding is equipment and process dependant. For this reason, it is strongly recommended that a thorough wire-bonding qualification is made by the end user if the sensor is going to be operated over an extended temperature range.

## LAYOUT (Absolute sensors)

MS761-A\_0.2

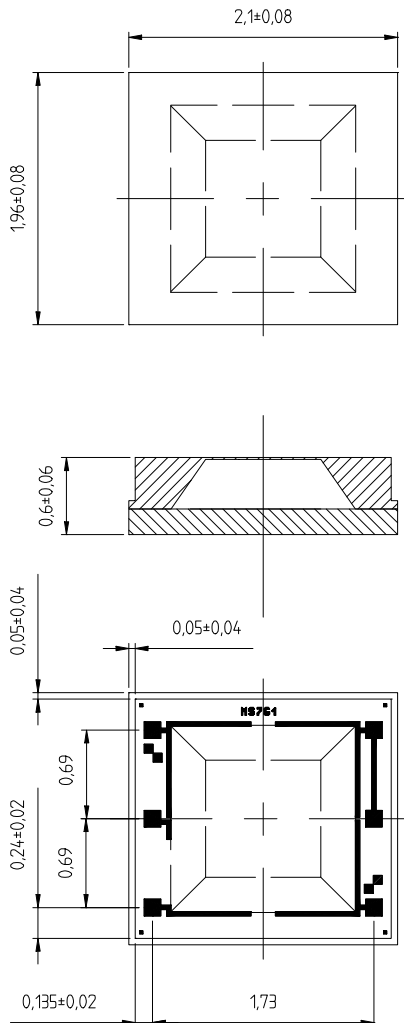

MS761-A\_0.5

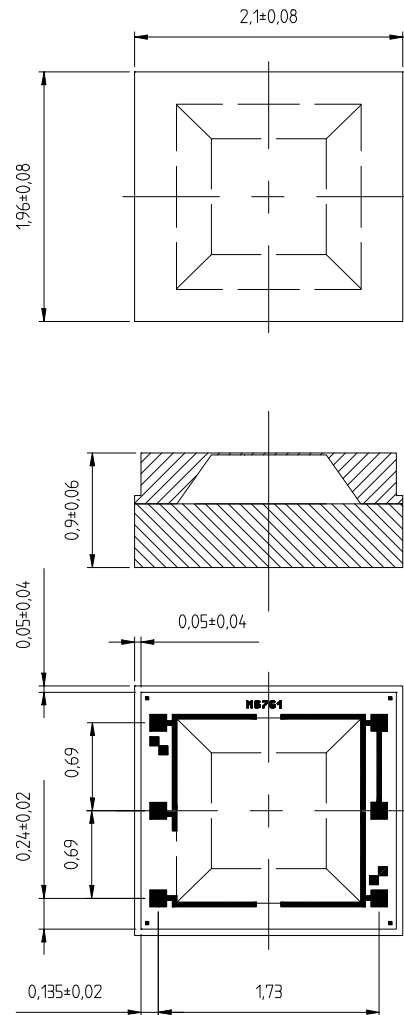

Pad opening in passivation is 100 µm

## LAYOUT (Gauge sensors)

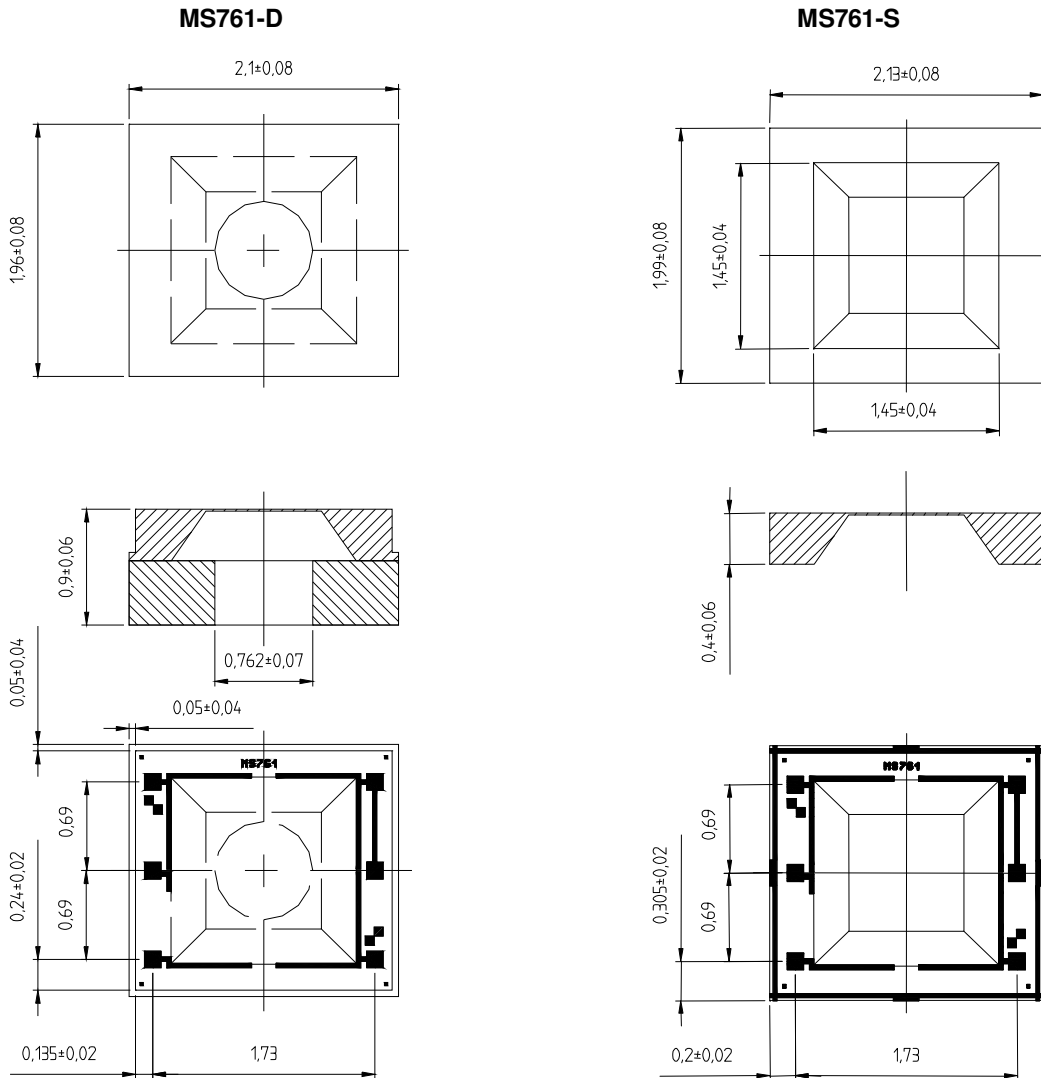

Pad opening in passivation is 100  $\mu\text{m}$

### FULL SCALE PRESSURE

kPa	bar	mbar	PSI	atm	mm Hg	m H <sub>2</sub> O	Inches H <sub>2</sub> O
100	1	1000	14.5	0.987	750	10.197	401

### ABSOLUTE MAXIMUM RATINGS

Parameter	Symbol	Conditions	Min	Max	Unit
Supply voltage	VS+	T <sub>a</sub> = 25 °C		20	V
Storage temperature	T <sub>s</sub>		-40	+150	°C
Pressure overload				5	Bar

## ELECTRICAL CHARACTERISTICS

(Reference conditions: Supply Voltage VS+ = 5 Vdc; Ambient Temperature Ta = 25°C)

Parameter	Min	Typ	Max	Unit	Notes
Operating Pressure Range	0		1	Bar	
Operating Temperature Range	-40		125	°C	
Bridge Resistance	3.0	3.4	3.8	kΩ	
Full scale span (FS)	190	240	290	mV	
Zero Pressure Offset	-40	0	40	mV	
Linearity		± 0.15	± 0.4	% FS	1
Temperature Coefficient of Resistance Span Offset	+ 2400 - 1500 - 80	+ 2800 - 1900	+ 3300 - 2300 + 80	ppm/°C ppm/°C μV/°C	2
Pressure Hysteresis		± 0.05	± 0.15	% FS	3
Repeatability		± 0.05	± 0.15	% FS	4
Temperature Hysteresis			0.3	% FS	5

### NOTES

- 1) Deviation at one half full-scale pressure from the least squares best line fit over pressure range (0 to 1 bar).
- 2) Slope of the endpoint straight line from 25°C to 60°C.
- 3) Output deviation at any pressure within the specified range, when this pressure is cycled to and from the minimum or maximum rated pressure, at 25°C.
- 4) Same as 3) after 10 pressure cycles
- 5) Maximum difference in offset after one thermal cycle from -40°C to +125°C.

### PICKING TOOLS

The MS761 sensors have a sensitive membrane size of 0.95 x 0.95 mm and outer dimensions of 2.1 x 1.96 mm (MS761-A\_0.2, MS761-A\_0.5 and MS761-D) and 2.13 x 1.99 mm (MS761-S). The pick and place tool has to be of a soft material such as rubber (Hardness 78-97 Shore A). Its external size must fit the sensor and the vacuum cavity size must be as large as the membrane itself. Successful tests have been made with specific SPT tools, see SPT drawing and references below.

Ensure that the ejection pins do not touch the membrane for gauge versions.

SPT references	RTR-A1-060x060	CTR-A1-080
External dimension	TL & TW: 0.06 inch / 1.52 mm	∅F: 0.08 inch / 2.03 mm
Internal dimensions	∅H: 0.035 inch / 0.89 mm	∅H: 0.035 inch / 0.89 mm

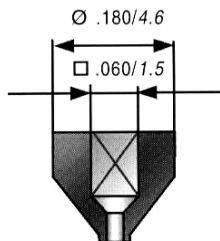

Type A

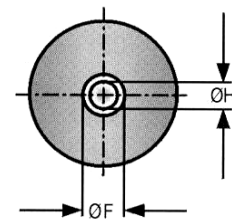
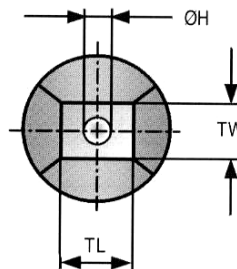

---

**ORDERING INFORMATION**

---

Product Code	Type	Product	Art.-Nr.
MS761-A_0.2	Absolute	1 bar Pressure Sensors 0.2 mm Pyrex sawn on b/f	76125022
MS761-A_0.5	Absolute	1 bar Pressure Sensors 0.5 mm Pyrex sawn on b/f	76125021
MS761-D	Differential	1 bar Pressure Sensors sawn on b/f	76125121
MS761-S	Differential	1 bar Pressure Sensors no Pyrex sawn on b/f	76125221

The MS761 dice are supplied sawn on blue foil, mounted on plastic rings

---

**FACTORY CONTACTS FACTORY CONTACTS**

---

**NOTICE**

Intersema reserves the right to make changes to the products contained in this data sheet in order to improve the design or performance and to supply the best possible products. Intersema assumes no responsibility for the use of any circuits shown in this data sheet, conveys no license under any patent or other rights unless otherwise specified in this data sheet, and makes no claim that the circuits are free from patent infringement. Applications for any devices shown in this data sheet are for illustration only and Intersema makes no claim or warranty that such applications will be suitable for the use specified without further testing or modification.