



HawkEye Technologies, LLC
Your Source for Infrared

181 Research Drive, #8
Milford, CT 06460
Phone: 203-878-6892
Fax: 203-878-7462

www.hawkeyetechnologies.com

Infrared Source Series 12

- Supported, Coil Wound
- Rugged and Reliable
- IR-12 & IR-12R operate at 900°C when powered with 10 watts
- IR-12K operates at 975°C when powered with 11 watts

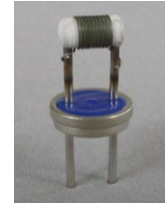

These popular units have been in production since 1980. They are considered rugged and reliable. The coiled filament operates at approximately 900°C when powered with 10 watts for the standard IR-12 and IR-12R sources and 975°C when powered with 11 watts for the IR-12K. The radiating element is a coil of resistance wire which has a high emissivity in the Infrared spectral region. The coil is supported on a grooved cylindrical substrate of alumina, resulting in the windings being electrically insulated from each other. This contributes to a more uniform radiating source. The unit does not require operation in a sealed atmosphere. The header is fabricated from cold-rolled steel. The support pins are hermetically sealed in glass.

The IR-12 Series is offered in several configurations. The standard IR-12 is shown below. The IR-12R is a standard IR-12 fabricated with the header flange in the reverse direction. The IR-12 Series also includes the IR-12K which uses Kanthal A-1 resistance wire for higher temperatures.

Recommended Operating Parameters

	IR-12 or IR-12R	IR-12K
Voltage	5.0 volts (AC or DC)	6.0 volts (AC or DC)
Temp	900° C	975°C
Current	2.0 Amperes	1.8 Amperes
Power	10.0 watts	11.0 watts
Life	30,000 Hours at 5 volts	30,000 Hours at 6 volts
Emissivity	0.80	0.80
Active Area	3.5 mm X 3.5 mm	3.5 mm X 3.5 mm



HawkEye Technologies, LLC
Your **Source** for **Infrared**

181 Research Drive, #8
Milford, CT 06460
Phone: 203-878-6892
Fax: 203-878-7462

www.hawkeyetechnologies.com

HawkEye IR-12 Engineering Data Charts

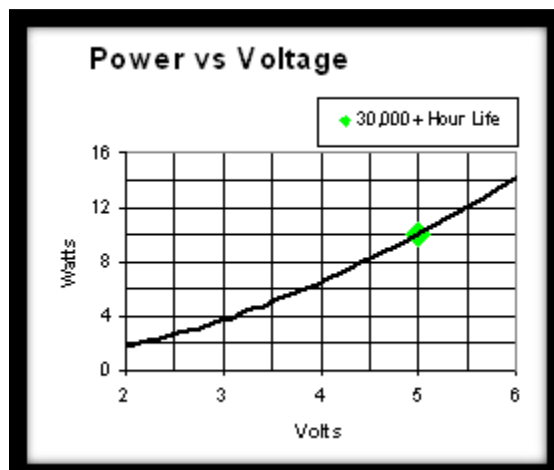
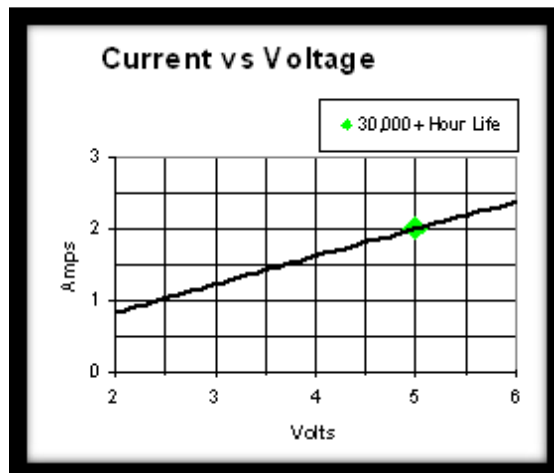
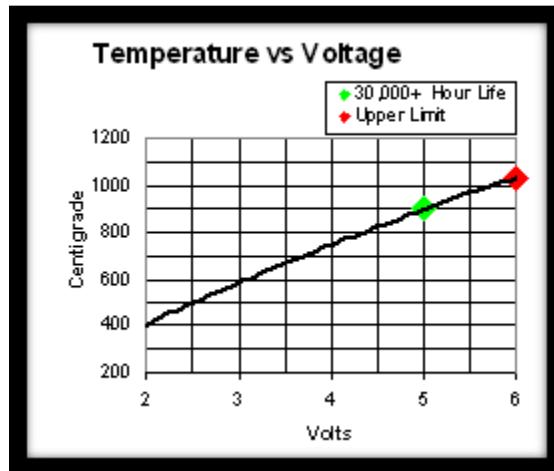



HawkEye Technologies, LLC
Your **Source** for **Infrared**

181 Research Drive, #8
Milford, CT 06460
Phone: 203-878-6892
Fax: 203-878-7462

www.hawkeyetechnologies.com

HawkEye IR-12K Engineering Data Charts

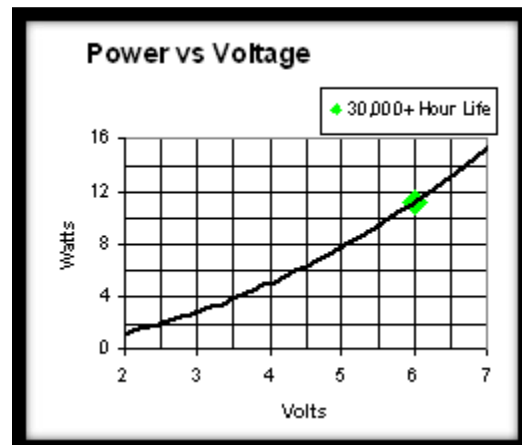
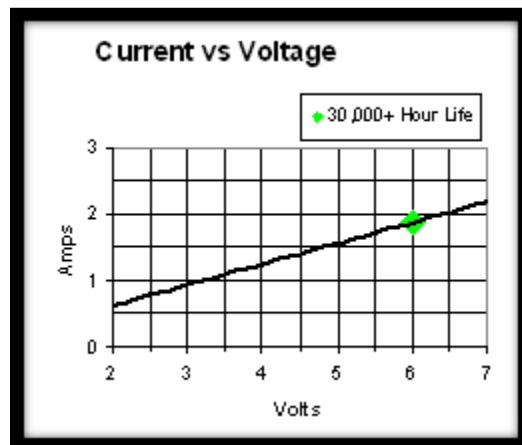
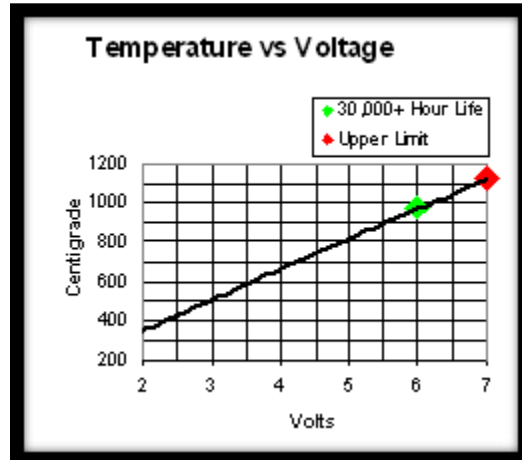



Hawkeye Technologies, LLC
Your Source for Infrared

181 Research Drive, #8
Milford, CT 06460
Phone: 203-878-6892
Fax: 203-878-7462

www.hawkeyetechnologies.com

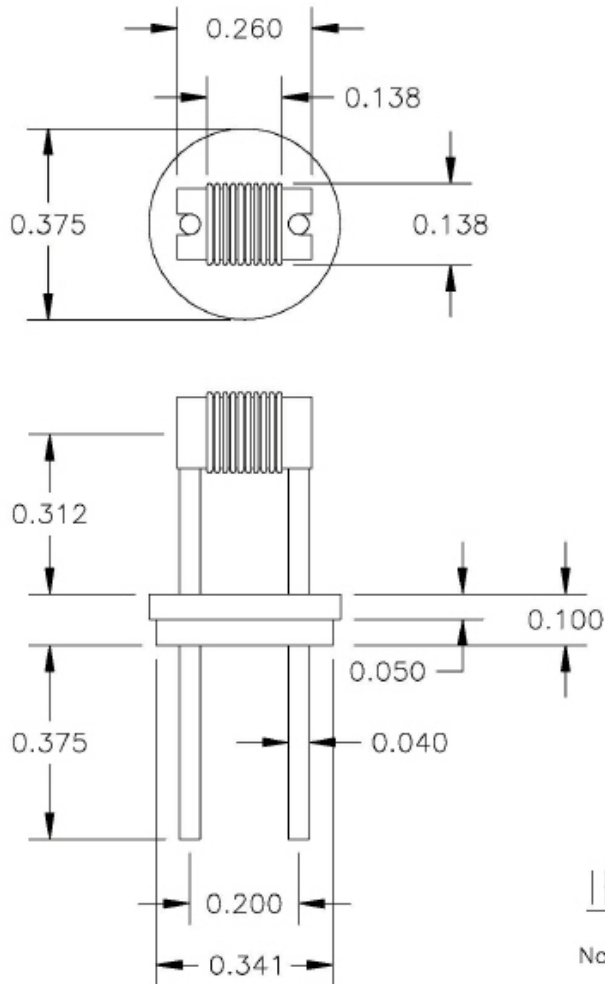

IR-12 Emitter

Note: all dimensions in inches.