

Infrared Components

Plastic Discrete Surface Mount Emitters and Detectors

SME/SMD Series

FEATURES

- Small package size
- Compatible with automated solder processes:
 - IR reflow
 - conductive epoxy
 - vapor phase reflow
 - convection oven
- Helps eliminate mixed technology PC boards
- Will operate in a DC or pulse mode for increased output
- Light pipe compatible
- Top-emitting and sensing area
- Low profile, small size for flexible layout of multiple channels and custom arrays
- Tape and reel packaging option - pick and place machine compatible

APPLICATIONS

- Optical encoders for motion control
- Computer peripherals
- Vending and point-of-sale applications
- Smoke detectors
- Medical equipment

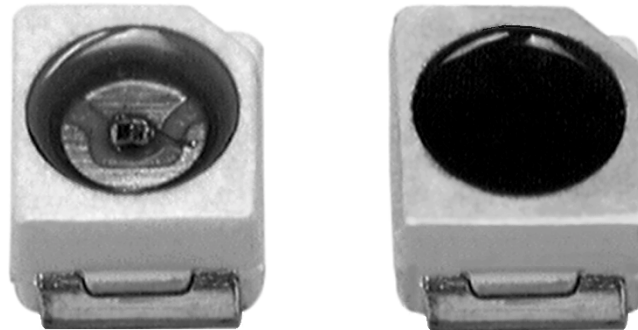

The SME6700 and SMD6400 Series surface mount infrared components are small plastic packages (2,8 mm x 3,2 mm x 1,5 mm/ 0.110 in x 0.126 in x 0.073 in) in an un-lensed, top emitting and sensing package.

These surface mount infrared components are designed for high density placement by automatic assembly machinery.

The SME6700 is an aluminum gallium arsenide infrared emitting diode (IRED). This component supplies optimum optical characteristics and can be used with the SMD6400 phototransistor. The small size and high power dissipation properties of the IRED promote PC (Printed Circuit) board miniaturization and high density placement.

These surface mount infrared components are available in bulk, or on tape and reel for use with automatic placement equipment.

Infrared Components

Plastic Discrete Surface Mount Emitters and Detectors

SME/SMD Series

SME6700 SERIES IRED ABSOLUTE MAXIMUM RATINGS

Power dissipation @ 25 °C ⁽¹⁾	100 mW
Continuous forward current	100 mA (mounted on a PC board)
Reverse voltage (I _F = 10 μA)	5 V
Operating free air temperature range	-40 °C to +85 °C (-104 °F to +185 °F)
Storage temperature	-40 °C to +85 °C (-104 °F to +185 °F)
Soldering temperature	260 °C (500 °F), 10 seconds max.

CAUTION

STRESS DAMAGE

Functional operation of the device at or above "Absolute Maximum Ratings" for extended periods of time may affect reliability.

Failure to comply with these instructions may result in product damage.

Note:

- Derate 0.78 mW/°C above 25 °C ambient.

SME6700 SERIES IRED ELECTRICAL CHARACTERISTICS (at 25 °C unless otherwise noted)

Parameter	Test Conditions	Sym.	Min.	Typ.	Max.	Units
Irradiance -001	I _F = 50 mA measured into 2,06 mm (0.081 in) dia. aperture located 18,16 mm (0.715 in) from the emitting surface	I _e	.40	.52		mW/cm ²
Forward voltage	I _F = 50 mA	V _F			1.8	V
Reverse breakdown voltage	I _R = 1 μA	V _R	5.0			V
Peak output wavelength	I _F = 50 mA	λ		880		nm
Spectral bandwidth	I _F = 50 mA	-λ		80		nm
Temperature coefficient of λ _P		-λ _P /λ		0.2		nm/°C
Beam angle ⁽¹⁾	I _F = constant	θ		120		deg.
Radiation rise/fall time	10 μsec pulse width	t _R t _F		0.7		Ts

Note:

- Beam angle is defined as the total included angle between the half power points.

TYPICAL IRED PERFORMANCE CHARACTERISTICS

SME6700 Spectral Bandwidth

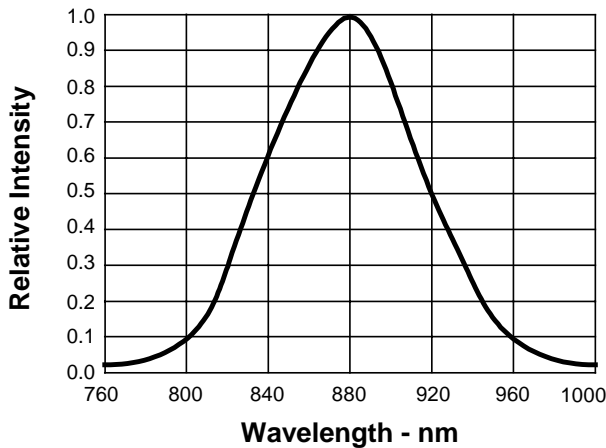

Infrared Components

Plastic Discrete Surface Mount Emitters and Detectors

SME/SMD Series

TYPICAL IRED PERFORMANCE CHARACTERISTICS (when solder mounted to PC board)

SME6700 Forward Current vs Forward Voltage

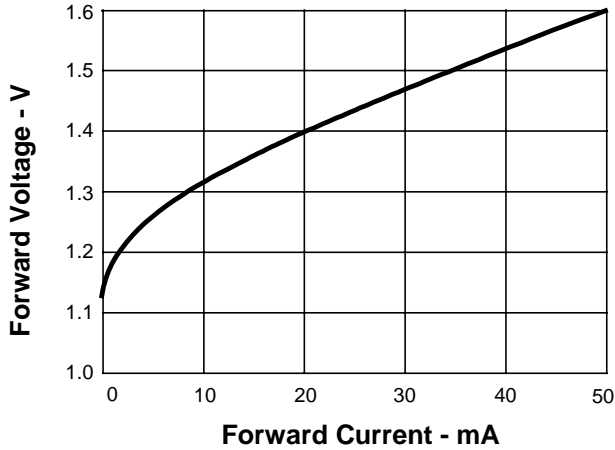

SME6700 Irradiance vs Temperature

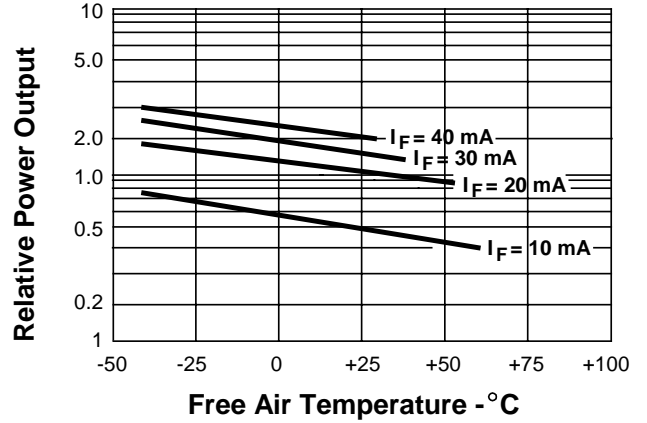

SME6700 Irradiance vs Forward Current

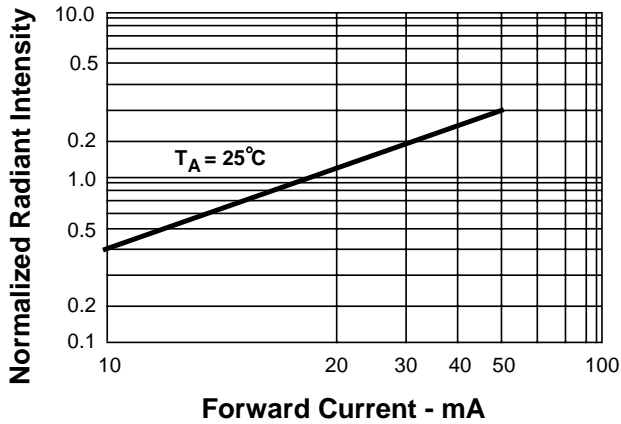

Infrared Components

Plastic Discrete Surface Mount Emitters and Detectors

*SME/SMD Series***SMD6400 SERIES PHOTOTRANSISTOR ABSOLUTE****MAXIMUM RATINGS (T_A = 25 °C)**

Collector-emitter voltage	35 V
Emitter-collector voltage	5 V
Continuous device dissipation ⁽¹⁾	100 mW
Operating free air range	-40 °C to +85 °C (-104 °F to +185 °F)
Storage temperature	-40 °C to +85 °C (-104 °F to +185 °F)
Soldering temperature	260 °C (500 °F), 5 seconds max.

Note:

- Derate 2.2 mW/°C above 25 °C ambient.

SMD6400 SERIES PHOTOTRANSISTOR ELECTRICAL CHARACTERISTICS

Parameter	Test Conditions	Sym.	Min.	Typ.	Max.	Units
Light current ⁽¹⁾	H = 0.1 mW/cm ² , V _{ce} = 5 V	I _c	16			μA
			16		32	μA
			25		50	μA
			40			μA
Dark current	V _{ce} = 25 V, H = 0	I _{ceo}			200	nA
Collector breakdown voltage	I _c = 100 μA, H = 0	BV _{ceo}	35			V
Emitter breakdown voltage	I _e = 100 μA, H = 0	BV _{eco}	5			V
Saturation voltage (C to E)	I _c = 0.3 × I _{C MINIMUM} , H = 0.1 mW/cm ²	V _{ce(SAT)}			0.15	V
Peak response wavelength		λ		935		nm
Angular response ⁽²⁾	I _f = constant	θ		120		deg.
Rise time	I _c = 1 mA, V _{ce} = 5 V, R _L = 1000 Ω	t _R		6 - 8		μs
Fall time		t _F		6 - 8		μs

Notes:

- The radiation source is an IRED with a peak wavelength of 935 nm.
- Angular response is defined as the total included angle between the half sensitivity points.

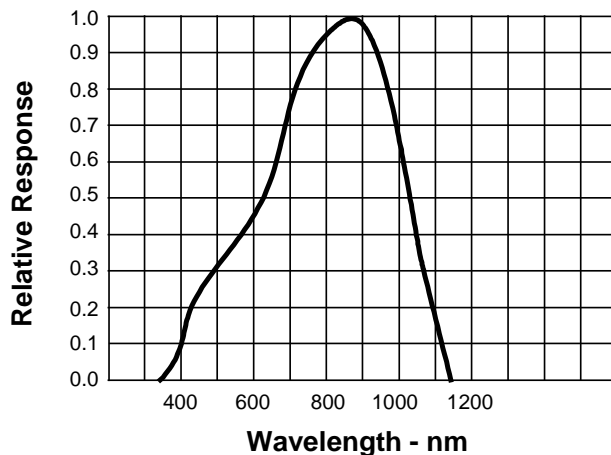
SMD6400 Spectral Responsivity

Infrared Components

Plastic Discrete Surface Mount Emitters and Detectors

SME/SMD Series

SMD6400 Collector Current vs Ambient Temperature

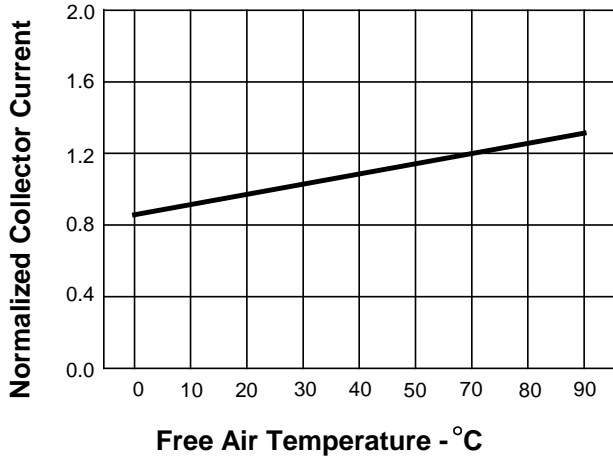

SMD6400 Dark Current vs Temperature

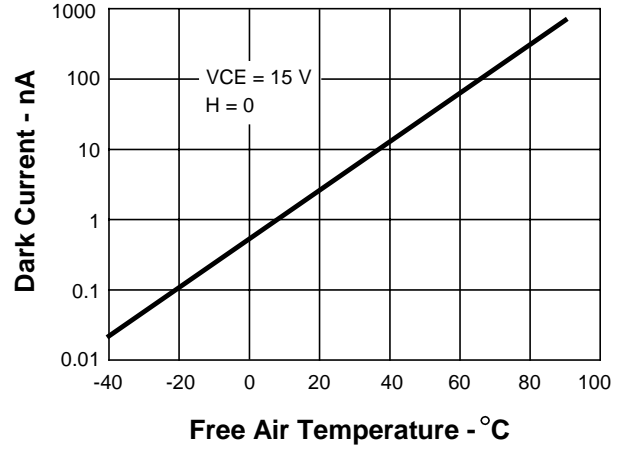

SMD6400 Switching Time Test Circuit

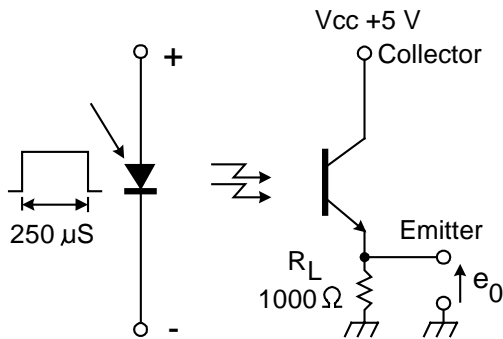

SMD6400 Switching Waveform

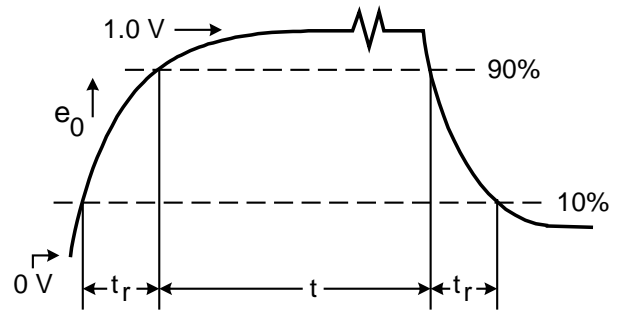

Infrared Components

Plastic Discrete Surface Mount Emitters and Detectors

SME/SMD Series

ORDER GUIDE

Catalog Listing	Description
SME6700-001B	Bulk Packaged, Surface Mount IR Emitter
SMD6400-001B	Bulk Packaged, Surface Mount Phototransistor
SMD6400-002B	Bulk Packaged, Surface Mount Phototransistor
SMD6400-003B	Bulk Packaged, Surface Mount Phototransistor
SMD6400-004B	Bulk Packaged, Surface Mount Phototransistor
SME6700-001T	Tape and Reel*, Surface Mount IR Emitter
SMD6400-001T	Tape and Reel*, Surface Phototransistor
SMD6400-002T	Tape and Reel*, Surface Phototransistor
SMD6400-003T	Tape and Reel*, Surface Phototransistor
SMD6400-004T	Tape and Reel*, Surface Phototransistor

*EIA STD 12 mm Tape and Reel with a 4 mm pitch. Consult factory for details.

SME6700 and SMD6400 OUTLINE DIMENSIONS mm/(in) (for reference only)

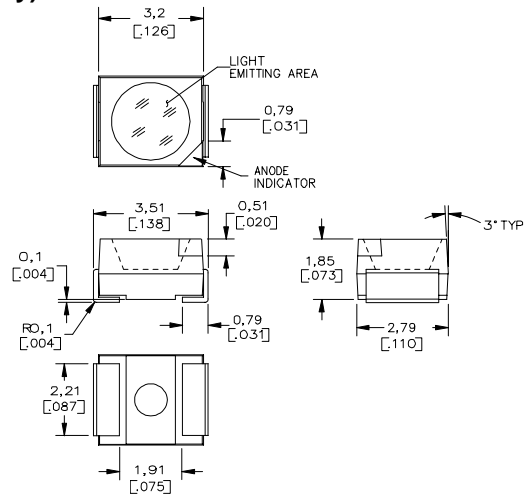

RECOMMENDED SOLDER PAD LAYOUT mm/(in)

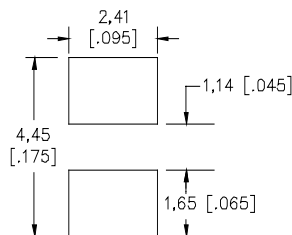

WARRANTY/REMEDY

Honeywell warrants goods of its manufacture as being free of defective material and faulty workmanship. Contact your local sales office for warranty information. If warranted goods are returned to Honeywell during that period of coverage, Honeywell will repair or replace without charge those items it finds defective. The foregoing is Buyer's sole remedy and is **in lieu of all other warranties, expressed or implied, including those of merchantability and fitness for a particular purpose.**

While we provide application assistance, personally, through our literature, and through the Honeywell website, it is up to the customer to determine the suitability of the product in the application.

Specifications may change without notice. The information we supply is believed to be accurate and reliable as of this printing. However, we assume no responsibility for its use.

While we provide application assistance personally, through our literature and the Honeywell web site, it is up to the customer to determine the suitability of the product in the application.

For application assistance,

Honeywell

Sensing and Control

Honeywell Inc.
11 West Spring Street
Freeport, Illinois 61032



Printed with Soy Ink
on 50% Recycled Paper

www.honeywell.com/sensing

SUNSTAR自动化 <http://www.sensor-ic.com/> TEL: 0755-83376489 FAX:0755-83376182 E-MAIL:szss20@163.com