

## Introduction

This application note aims for users to understand the method of tilt detection using piezoresistive type 3-axis acceleration sensor (HAAM-326B).

This application note explains using digital value which is converted from analog value of acceleration that piezoresistive type 3-axis acceleration sensor (HAAM-326B) outputs.

Reference: HAAM-326B catalog <http://www.hdk.co.jp/pdf/eng/e137507.pdf>

3-axis acceleration sensor application note (Calibration of sensors' individual difference)

Tilt detection means to detect tilted angle when rotating 3-axis acceleration sensor 360 degrees. By using the tilt detection, application which imitates tilt of 3-axis acceleration sensor can be made as the figure below.

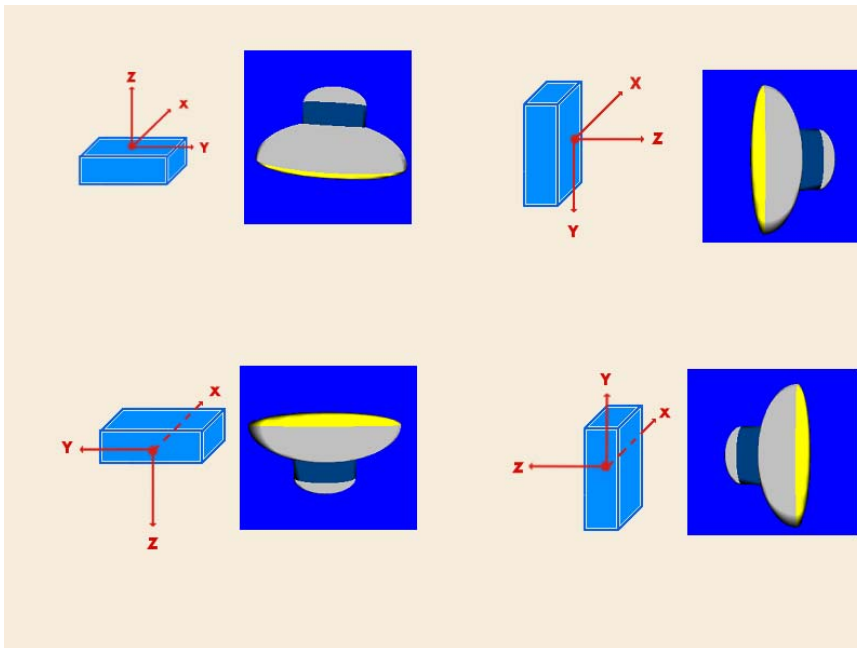

Figure 1 Application image using tilt detection

Piezoresistive type 3-axis acceleration sensor HAAM-326B

Tilt Detection

Feb, 2007 1st edition

1 Composition

This application note explains using 78K0/KB2 (uPD78F0500) as an example CPU which connects to HAAM-326B.

Please refer to HAAM-326B catalog for electrical characteristics.

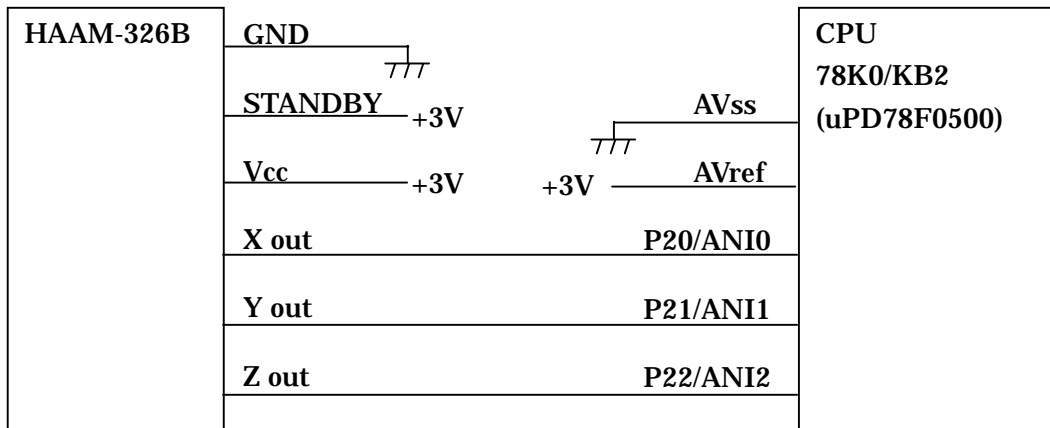

**Figure 2** Connection of HAAM-326B and CPU

Piezoresistive type 3-axis acceleration sensor HAAM-326B

Tilt Detection

Feb, 2007 1st edition

■ Input voltage and conversion result

There is a relation between analog input voltage that put into the analog input terminal (ANI0-ANI2) and logical A/D conversion result (10-bit A/D conversion result register) as the figure below.

The 78K0/KB2 used in this application note shows the figure below.

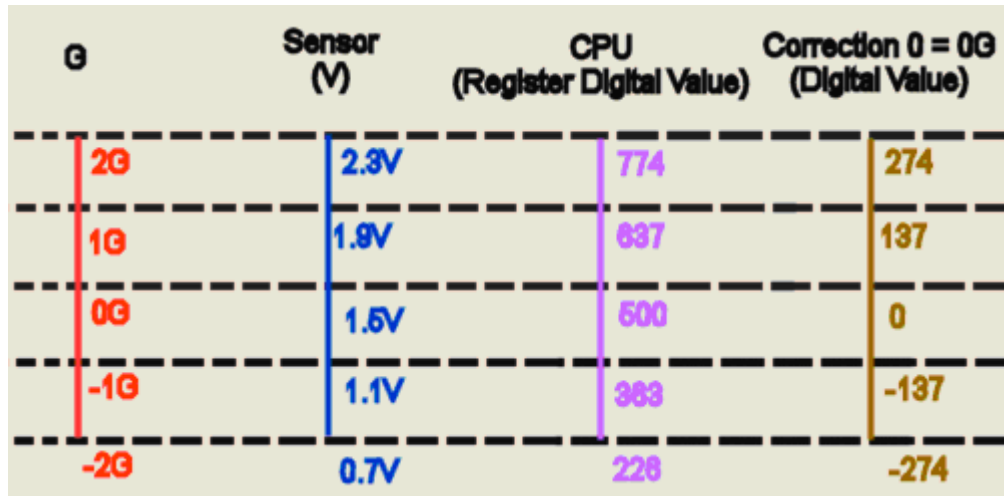

Figure 3 Input voltage and conversion result

■ Value to use on conversion result

In this application note, the digital value at 0G is considered as 0.

Figure 3 input voltage which adds offset to A/D conversion result and value of Correction0=0G (digital value) that is the conversion result will be used on later explanation.

■ Sampling rate

In this application note, XYZ is sampled every 4ms.

Piezoresistive type 3-axis acceleration sensor

HAAM-326B

Tilt Detection

Feb, 2007 1st edition

2 Algorithm of tilt detection

■ Tilt detection of X-axis rotation

Rotation of X-axis is calculated on the basis of numerical value of X and  $\pm$  of Z, as shown in the following table.

Angle(degree)	X	Z	Formula
0	0	-137	In case of $X \leq 0$ and $Z \leq 0$  Angle = $\sin^{-1} (-X/137)$
30	-69	-	
60	-119	-	
90	-137	$\pm 0$	
90	-137	$\pm 0$	In case of $X \leq 0$ and $Z > 0$  Angle = $180 - \sin^{-1} (-X/137)$
120	-119	+	
150	-69	+	
180	0	+137	
180	0	+137	In case of $X \geq 0$ and $Z > 0$  Angle = $180 + \sin^{-1} (X/137)$
210	69	+	
240	119	+	
270	137	$\pm 0$	
270	137	$\pm 0$	In case of $X \geq 0$ and $Z \leq 0$  Angle = $360 - \sin^{-1} (X/137)$
300	119	-	
330	69	-	
360	0	-137	

Table 1 Calculation table of X-axis angle

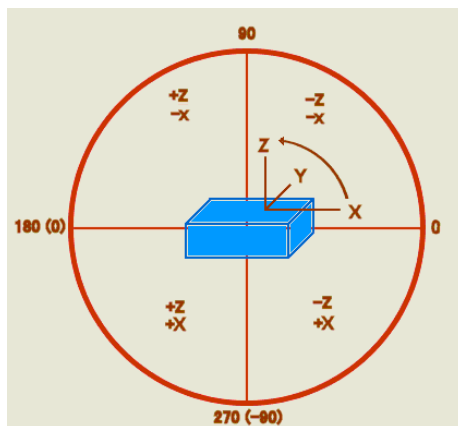

Figure 4 Image of angle that X-axis is aiming

Piezoresistive type 3-axis acceleration sensor

HAAM-326B

Tilt detection

Feb, 2007 1st edition

■ Tilt detection of Y-axis rotation

Rotation of Y-axis is calculated on the basis of numerical value of Y and  $\pm$  of Z, as shown in the following table.

Angle(degree)	Y	Z	Formula
0	0	-137	In case of $Y \leq 0$ and $Z <= 0$  Angle = $\sin^{-1} (-Y/137)$
30	-69	-	
60	-119	-	
90	-137	$\pm 0$	
90	-137	$\pm 0$	In case of $Y <= 0$ and $Z >= 0$  Angle = $180 - \sin^{-1} (-Y/137)$
120	-119	+	
150	-69	+	
180	0	+137	
180	0	+137	In case of $Y >= 0$ and $Z >= 0$  Angle = $180 + \sin^{-1} (Y/137)$
210	69	+	
240	119	+	
270	137	$\pm 0$	
270	137	$\pm 0$	In case of $Y >= 0$ and $Z <= 0$  Angle = $360 - \sin^{-1} (Y/137)$
300	119	-	
330	69	-	
360	0	-137	

Table 2 Calculation table of Y-axis angle

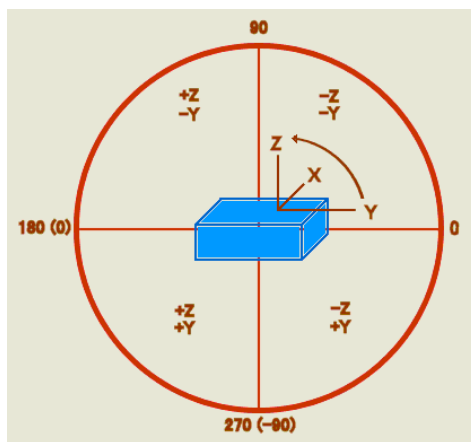

Figure 5 Image of angle that Y-axis is aiming

Piezoresistive type 3-axis acceleration sensor

HAAM-326B

Tilt Detection

Feb, 2007 1st edition

■ Tilt detection by three dimensions

By combining X-axis angle and Y-axis angle, the position on three dimensions can be obtained, as shown in the following figure.

At Y= 90 degrees and X= 150 degrees, it tilted three-dimensionally in direction of the blue arrow of the following figure.

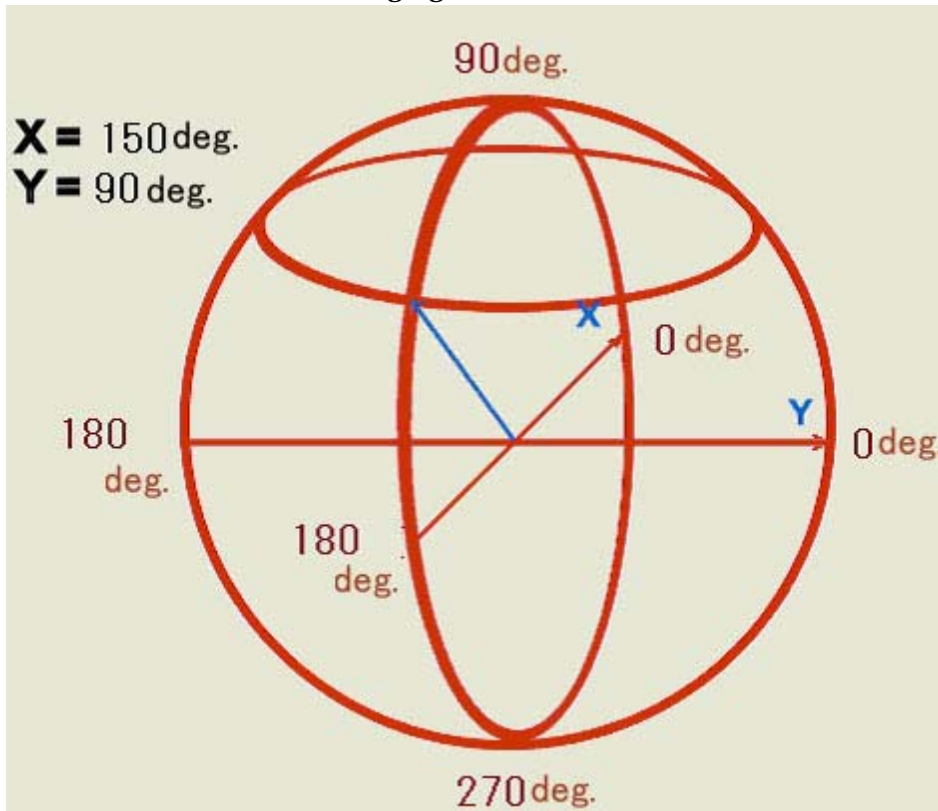

Figure 6 at X= 150 degrees and Y= 90 degrees

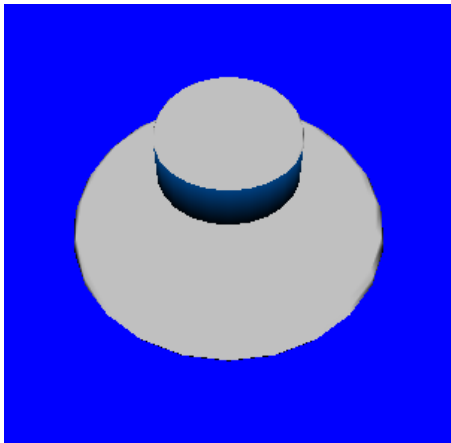

Figure 7 Image of application at X= 150 degrees and Y= 90degrees

Piezoresistive type 3-axis acceleration sensor

HAAM-326B

Tilt Detection

Feb, 2007 1st edition

At Y= 150 degrees and X= 150 degrees, it tilted three-dimensionally in direction of the blue arrow of the following figure.

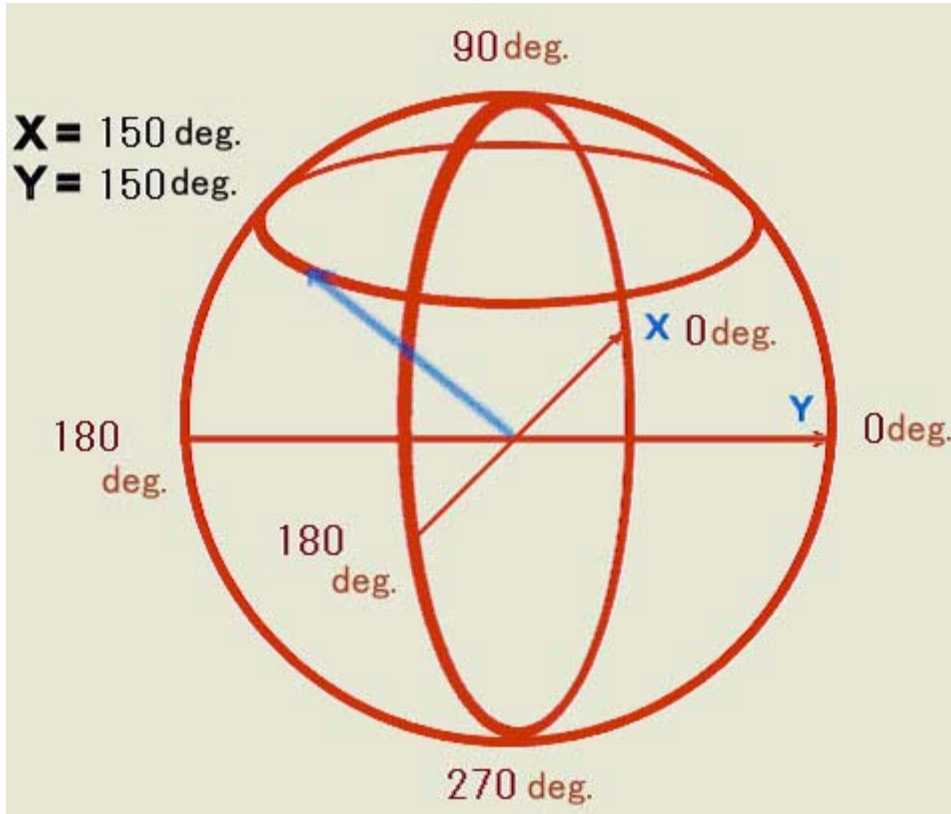

Figure 8 at X= 150 degrees and Y= 150 degrees

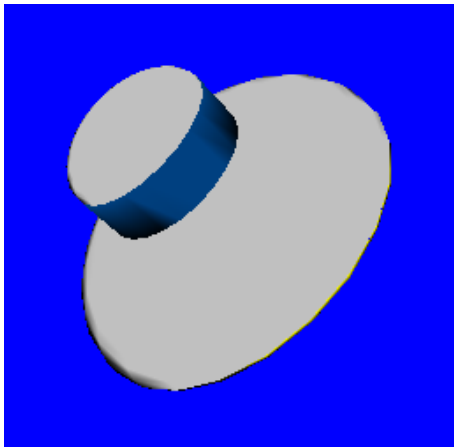

Figure 9 Image of application at X= 150 degrees and Y= 150degrees

Piezoresistive type 3-axis acceleration sensor

HAAM-326B

Tilt Detection

Feb, 2007

1st edition

At Y= 170 degrees and X= 150 degrees, it tilted three-dimensionally in direction of the blue arrow of the following figure.

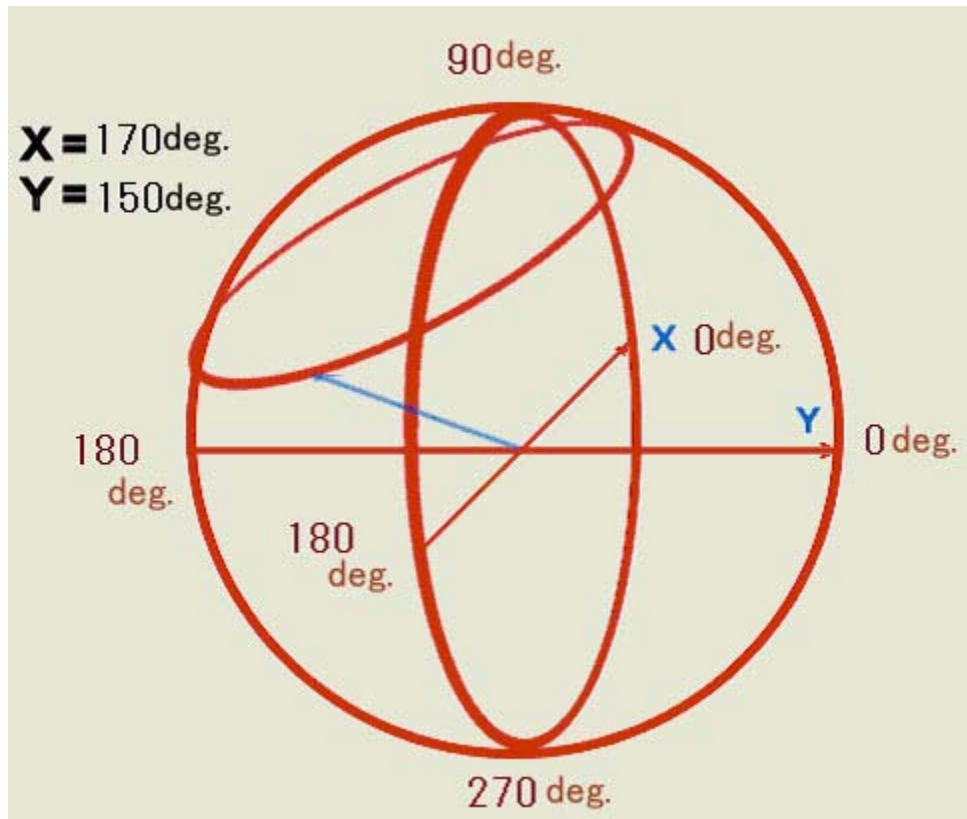

**Figure 10 at X= 170 degrees and Y= 150 degrees**

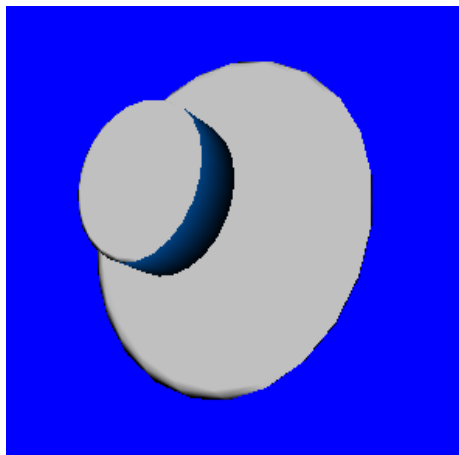

**Figure 11 Image of application at X= 170 degrees and Y= 150degrees**



Piezoresistive type 3-axis acceleration sensor HAAM-326B

Tilt Detection

Feb, 2007 1st edition

---

### 3 Discernment of tilt and move

It is necessary to identify each operation so as not to misjudge tilt and move.

Tilt, stop, and move have the following differences, respectively.

- Tilt (Figure 12 Data graph of rotating sensor one-turn in the direction of X-axis)  
3-axis composite value: Continue taking value near 1G  
Each axis: It changes, respectively.
  - Stop (Figure 13 Data graph when sensor being stopped)  
3-axis composite value: Continue taking value near 1G  
Each axis: Each axis does not change.
  - Movement (Figure 14 Data graph when moving a sensor)  
3-axis composite value: The value beyond 1G is taken.  
Each axis: It changes, respectively.
- (Note) 3-axis composite value is x, y, and z axis compounded. Unless intense operation is applied to sensor, sum total of three axes becomes 1G.  
By these differences, operation added to sensor is discerned.

Piezoresistive type 3-axis acceleration sensor

HAAM-326B

Tilt Detection

Feb, 2007 1st edition

■ Discernment of tilt

As long as 3-axis composite value continues taking value near 1G (137±25 at digital value), tilt detection is made.

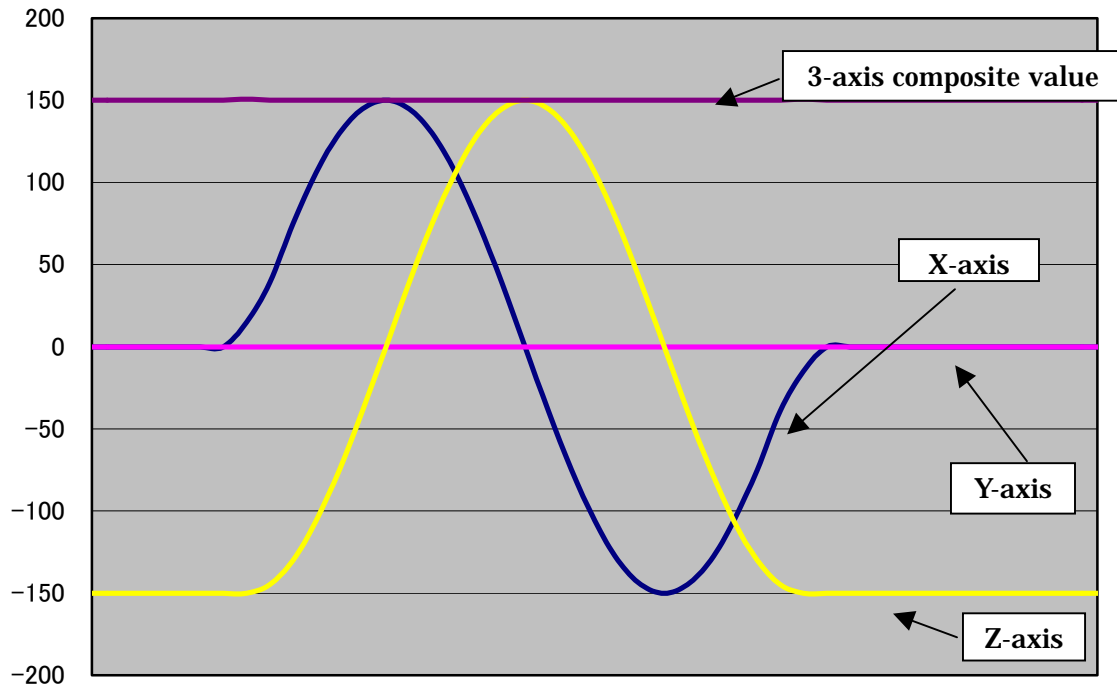

Figure 12 Data graph of rotating sensor one-turn in the direction of X-axis

Piezoresistive type 3-axis acceleration sensor

HAAM-326B

Tilt Detection

Feb, 2007 1st edition

■ Discernment of stop

As long as 3-axis composite value continues taking value near 1G (137±25 at digital value), tilt detection is made.

If delicate vibration of sensor prevented flickering tilting, tilt X and Y more than ±10 degrees, then start tilt discernment. This way, fluctuation by the delicate vibration can be avoided.

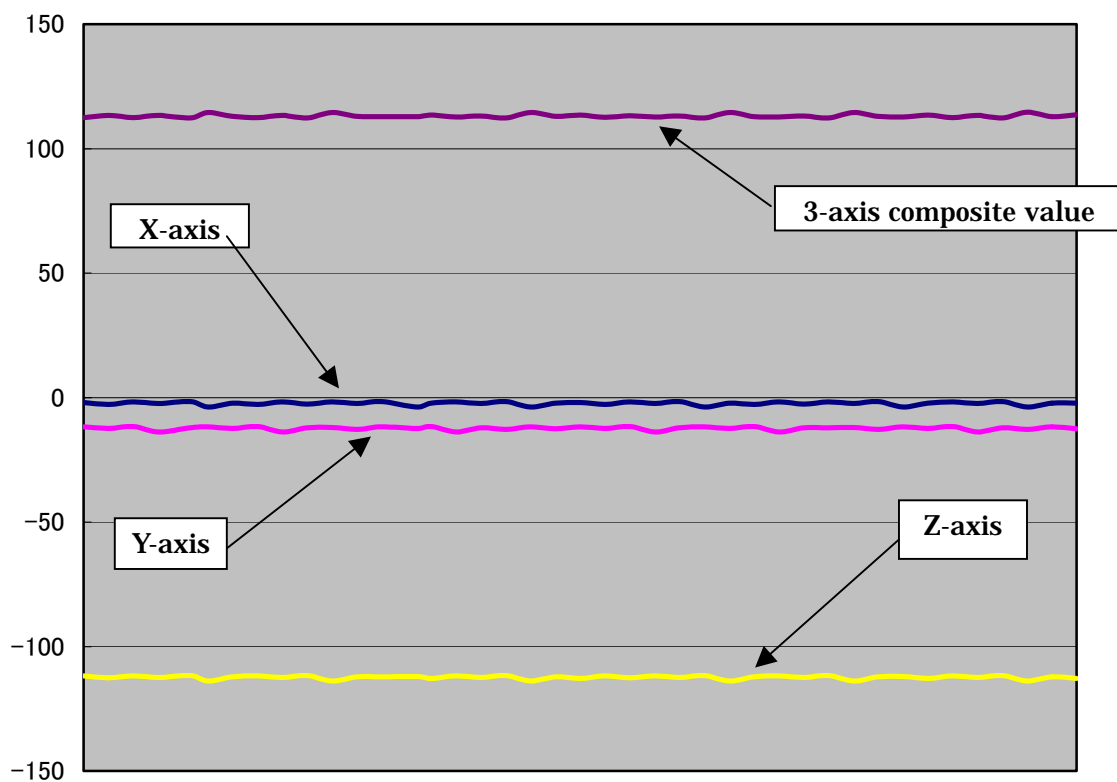

Figure 13 Data graph when sensor being stopped

Piezoresistive type 3-axis acceleration sensor

HAAM-326B

Tilt Detection

Feb, 2007 1st edition

■ Discernment of move

When moving a sensor to front, back, right, left or aslant, 3-axis composite value deviates from 1G at the time of initial move. While the deviation is happening, correct tilt can not be detected.

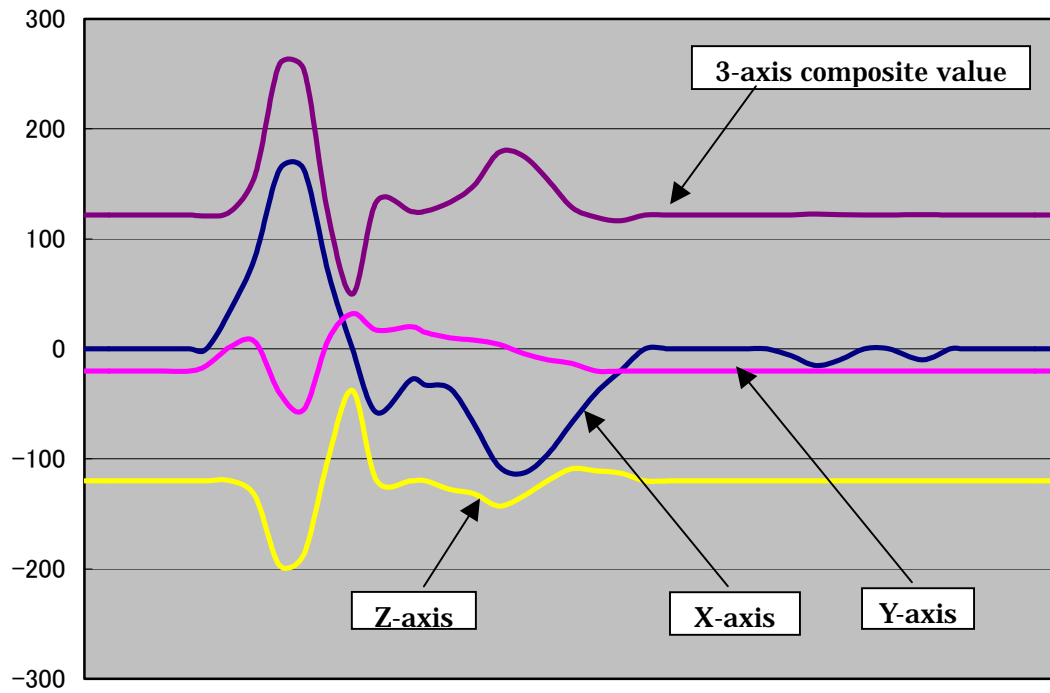

Figure 14 Data graph when moving a sensor

Piezoresistive type 3-axis acceleration sensor

HAAM-326B

Tilt Detection

Feb, 2007 1st edition

#### 4 Problem and solution about angle setting

##### ■ Problem

Digital value when tilting a sensor is as follows.

Angle(degree)	Digital value (X or Y)
0	0
30	69
60	119
90	137
120	119
150	69
180	0
210	-69
240	-119
270	-137
300	-119
330	-69
360	0

0~90 degrees be the first quadrant.

90~180 degrees be the second quadrant.

180~270 degrees to the third quadrant.

270~360 degrees be the fourth quadrant.

When tilting sensor in the range of first quadrant, digital value takes 0~137.

However, also when tilting sensor in second quadrant, digital value will take same 0~137 as the first quadrant.

This is because when tilting sensor beyond 90 degrees, digital value decreases, in spite of being sensor itself in second quadrant. Therefore, it can not judge whether the tilt is in first quadrant or second quadrant, only by seeing digital value. (Same thing can happen on third quadrant and fourth quadrant, as well.)

Piezoresistive type 3-axis acceleration sensor

HAAM-326B

Tilt Detection

Feb, 2007 1st edition

■ Solution method

To solve the problem of angle setup, it is possible by seeing Z-axis.

By seeing Z-axis as shown in the following figures, difference appears in first quadrant~fourth quadrant respectively and judgment be made.

Axis	first quadrant 0~90	second quadrant 90~180	third quadrant 180~270	fourth quadrant 270~360
X or Y	Plus	Plus	Minus	Minus
Z	Minus	Plus	Plus	Minus

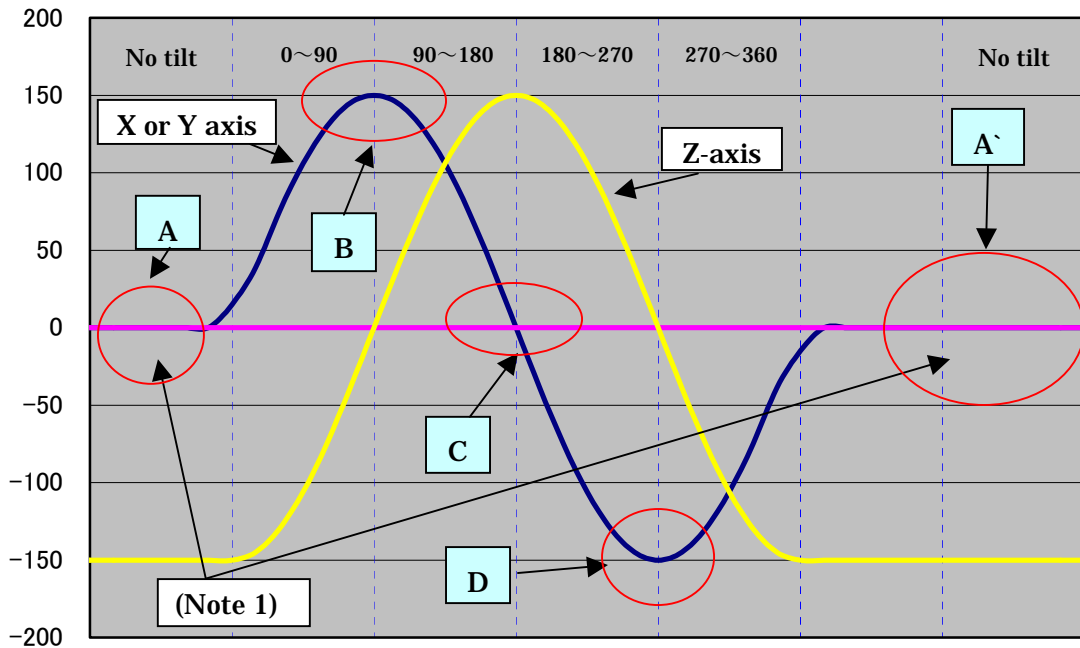

(Note 1) Sensor is in state not being tilted at this stage, since it is intended not to judge as tilt until digital value change to some extent, in order to discern sensor stop state.

A, A'

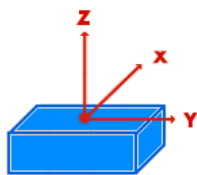

B

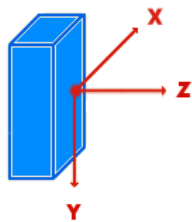

C

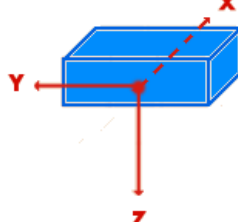

D

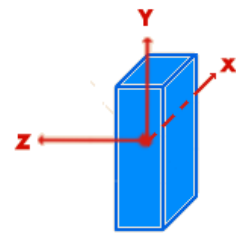

Piezoresistive type 3-axis acceleration sensor

HAAM-326B

Tilt Detection

Feb, 2007 1st edition

### 5 Problem of rotation

Since major change does not appear in each axis of X, Y, and Z on sensor when rotating on perpendicular axis to gravity, it is judged as sensor being stopped state. This problem can not be avoided only by sensor itself.

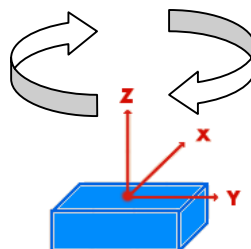
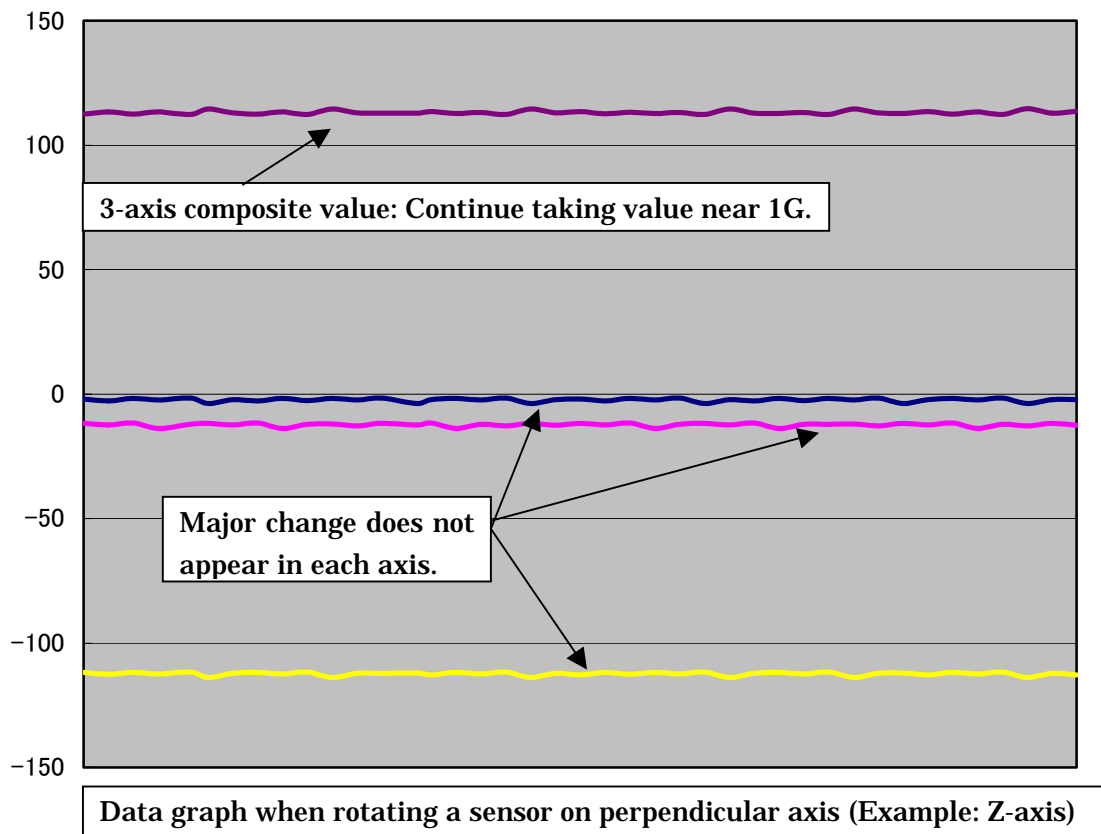

Piezoresistive type 3-axis acceleration sensor HAAM-326B

Tilt Detection

Feb, 2007 1st edition

---

■ Judgment method of tilt

In order to judge tilt, all the following conditions have to be met.

**Tilt conditions 1: 3-axis composite value continue taking value near 137 (1G).**

(It is recommended that difference of 3-axis composite value and 137 (1G) is less than  $\pm 25$ ).

**Tilt conditions 2: Digital value of sensor detects some change even in stop state.**

In order not to detect tilt at the time of stop, unless neither X or Y-axis exceeds  $\pm 10$ , make it not judge as tilt.

**Tilt conditions 3: Since change in digital value is gradual when tiling sensor, difference (absolute value) of last time value and this time value continues taking near 0 (10 or less).**

**Tilt conditions 4: Tilt conditions 1~3 continue (20 msec or more recommended).**

Since sampling rate is 4ms in this application note, conditions are met with five consecutive times.