

T-41-53

PHOTO DIODE PH310

PLASTIC MOLDED PIN PHOTO DIODE

PACKAGE DIMENSIONS in millimeters

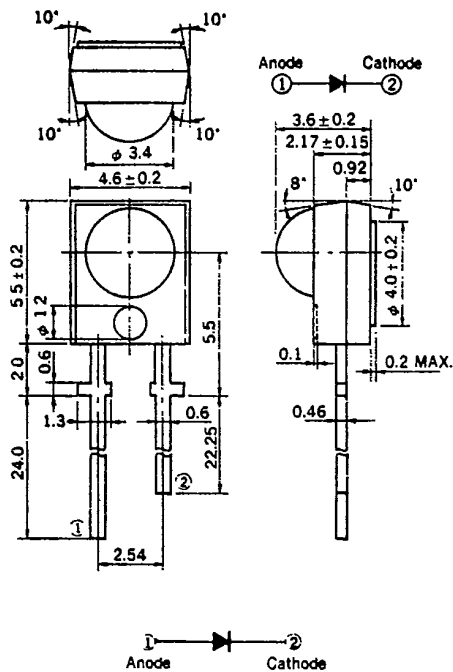

DESCRIPTION

PH310 is a photo diode with PIN structure. It has a wide photo-receiving area and high speed response enabling applications for various remote controlling equipments. The resin material itself used for the package has filter effect to pass only infrared.

FEATURES

- Ultra high speed response. ($t_r, t_f \approx 30$ ns)
- Coincidence of the wavelength of maximum sensitivity with that of an infrared LED. (λ_s MAX. = 990 nm)
- High sensitivity. [$5 \mu A$ TYP. (@ $V_R = 5$ V, $H = 0.1$ mW/cm²)]
- Wide dynamic range.

ABSOLUTE MAXIMUM RATINGS

Maximum Reverse Voltage ($T_a = 25^\circ C$)	V_R	32	V
Maximum Power Dissipation ($T_a = 25^\circ C$)	P_D	150	mW
Maximum Temperatures			
Operating Temperature	T_{opt}	-30 to +85	$^\circ C$
Storage Temperature	T_{stg}	-40 to +100	$^\circ C$

PH310

T-41-53

ELECTRO-OPTICAL CHARACTERISTICS ($T_a = 25^\circ\text{C}$)

CHARACTERISTIC	SYMBOL	MIN.	TYP.	MAX.	UNIT	TEST CONDITIONS
Dark Current	I_R			10	nA	$V_R = 10\text{ V}$
Wavelength of the max. sensitivity	λ_s MAX.		990		nm	
Quantum yield (Electron per photon)	η		0.88			$\lambda = 940\text{ nm}$
Spectral sensitivity	S	25	32		nA/lx	$V_R = 5\text{ V}$
Spectral sensitivity	S_{IR}	4.0	5.0		μA	$V_R = 5\text{ V}, H = 0.1\text{ mW/cm}^2$
Rise and fall time of the photocurrent from 10 % to 90 % and 90 % to 10 % of the final value	t_r, t_f		120		ns	$R_L = 1\text{ k}\Omega, V_R = 0\text{ V}, \lambda = 940\text{ nm}$
	t_r, t_f		30		ns	$R_L = 1\text{ k}\Omega, V_R = 5\text{ V}, \lambda = 940\text{ nm}$
Capacitance	C_t		11		pF	$V_R = 5\text{ V}, f = 1\text{ MHz}$
Radiant sensitive area	A		5.3		mm^2	

* $\lambda = 940\text{ nm}$

TYPICAL CHARACTERISTICS ($T_a = 25^\circ\text{C}$)

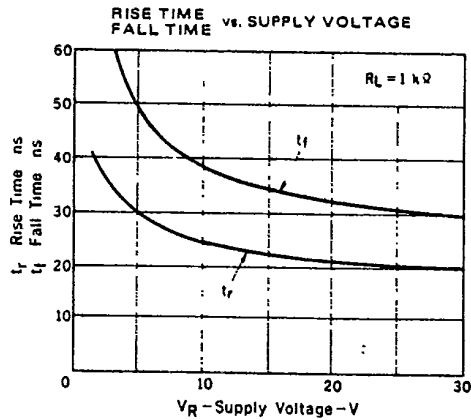
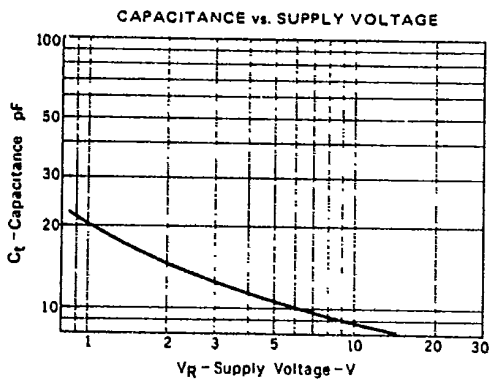
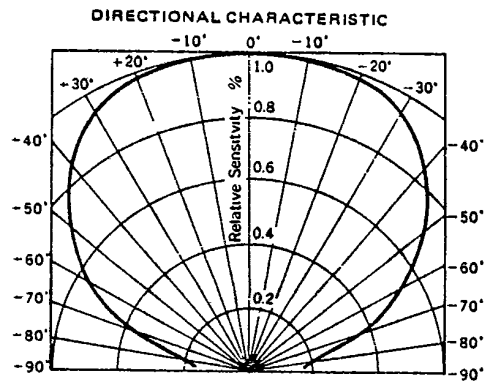
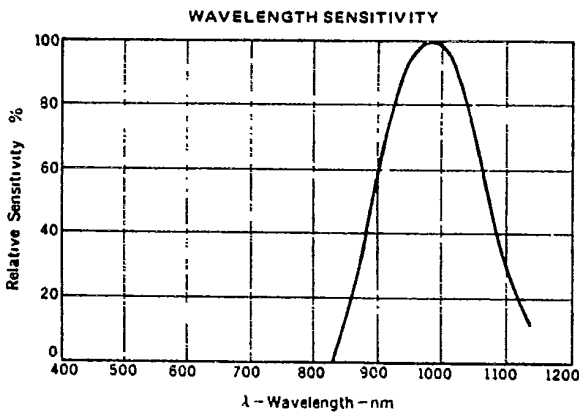

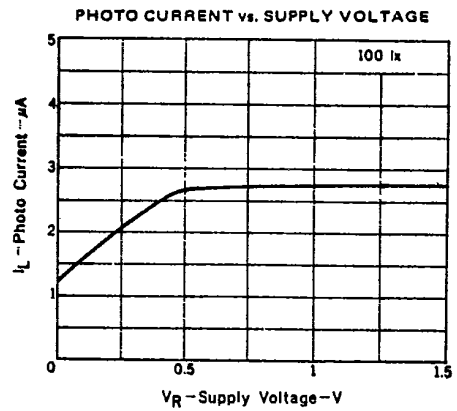
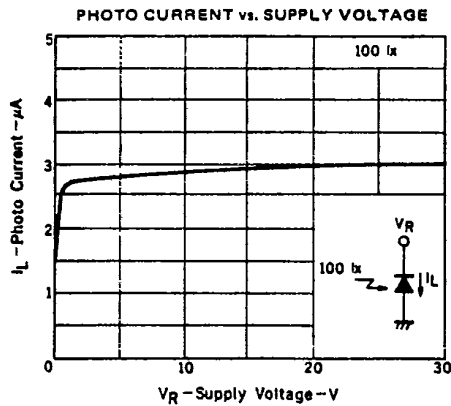
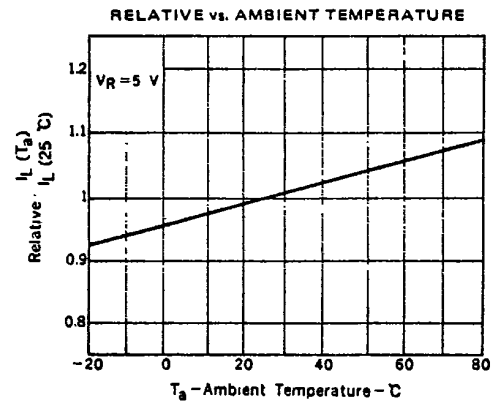
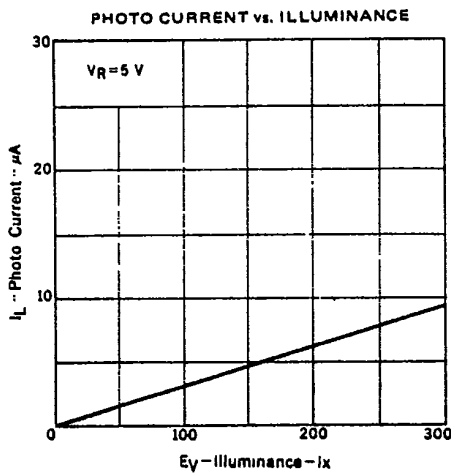
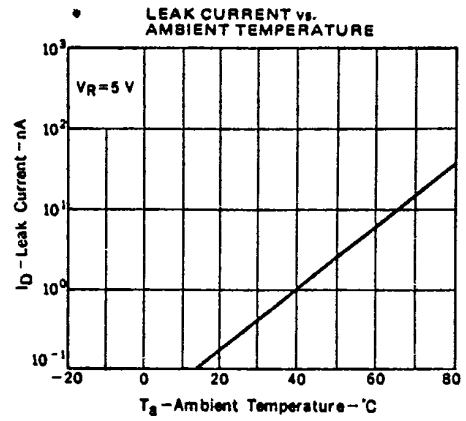
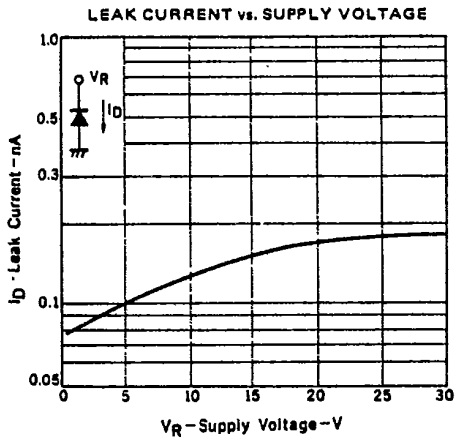

PH310

T-41-53

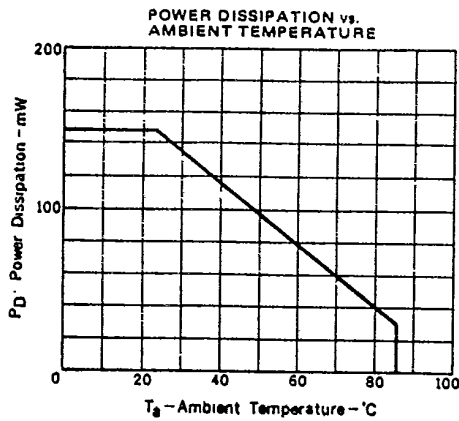

HANDLING PRECAUTIONS:

1. The full resin-molded PH310 has generally a little less mechanical and thermal strength than other resin-molded semiconductor devices as they have less additives. Therefore please note on the following points.
 - (a) Soldering of leads should be made at the point 5 mm or more from the root of the leads at 260 °C and within 5 s.
 - (b) If the temperature of the molded portion rises in addition to the residual stress between the leads, the possibility that open or short circuit occurs due to the deformation or destruction of the resin will increase.
2. On cleaning the device:
 - (a) Cleaning with unsuitable solvent may impair the resin if the package and the following solvents should be used at the temperature of less than 45 °C and for less than 3 minutes of immersion time.
 - Ethanol, Methanol
 - Isopropyl-alcohol
 - (b) Ultrasonic cleaning will add some stress on devices. The degree of the stress differs depending on the oscillation output power, the size of the PCB and the mounting methods of the devices, therefore it should be confirmed by making an experiment at actual conditions that the cleaning does not have any problem on the devices.