

**DISCRETE SEMICONDUCTORS**

# DATA SHEET

## **BLV958; BLV958FL** UHF power transistors

Product specification  
Supersedes data of 1997 Oct 15

2000 Jan 12

## UHF power transistors

## BLV958; BLV958FL

## FEATURES

- Internal input and output matching for easy matching, high gain and efficiency
- Poly-silicon emitter ballasting resistors for an optimum temperature profile
- Gold metallization ensures excellent reliability.

## APPLICATIONS

- Base stations in the 800 to 960 MHz frequency range.

## DESCRIPTION

NPN silicon planar epitaxial transistors primarily intended for common emitter class-AB operation. The transistors have internal input and output matching by means of MOS capacitors. The encapsulations are a 2-lead rectangular SOT391A flange package and a SOT391B flangeless package, both with a ceramic cap.

## PINNING - SOT391A

PIN	SYMBOL	DESCRIPTION
1	c	collector
2	b	base
3	e	emitter; connected to flange

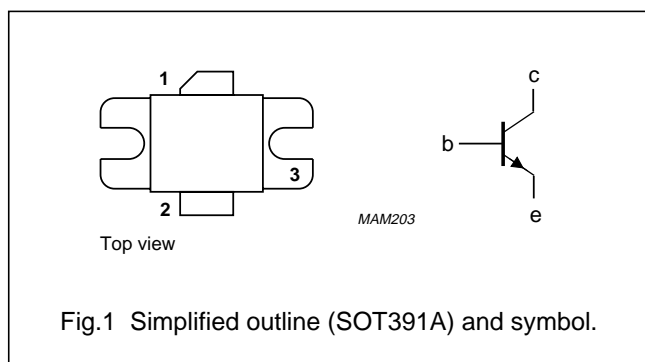

## PINNING - SOT391B

PIN	SYMBOL	DESCRIPTION
1	c	collector
2	b	base
Ground plane	e	emitter

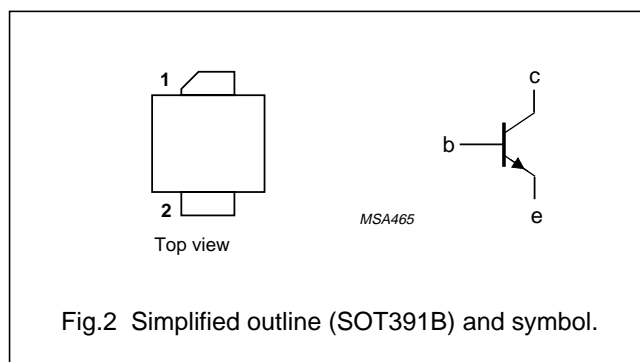

## QUICK REFERENCE DATA

RF performance at  $T_h = 25\text{ }^\circ\text{C}$  in a common emitter test circuit.

MODE OF OPERATION	f (MHz)	$V_{CE}$ (V)	$P_L$ (W)	$G_p$ (dB)	$\eta_c$ (%)
CW, class-AB	900	26	75	$\geq 8$	$\geq 50$
	960	26	75	$\geq 8.5$	$\geq 50$

## WARNING

## Product and environmental safety - toxic materials

This product contains beryllium oxide. The product is entirely safe provided that the BeO disc is not damaged. All persons who handle, use or dispose of this product should be aware of its nature and of the necessary safety precautions. After use, dispose of as chemical or special waste according to the regulations applying at the location of the user. It must never be thrown out with the general or domestic waste.

## UHF power transistors

## BLV958; BLV958FL

**LIMITING VALUES**

In accordance with the Absolute Maximum Rating System (IEC 134).

SYMBOL	PARAMETER	CONDITIONS	MIN.	MAX.	UNIT
V <sub>CBO</sub>	collector-base voltage	open emitter	–	70	V
V <sub>CEO</sub>	collector-emitter voltage	open base	–	30	V
V <sub>EBO</sub>	emitter-base voltage	open collector	–	3	V
I <sub>C</sub>	collector current (DC)		–	15	A
I <sub>C(AV)</sub>	average collector current		–	15	A
P <sub>tot</sub>	total power dissipation	T <sub>mb</sub> ≤ 25 °C	–	250	W
T <sub>stg</sub>	storage temperature		–65	+150	°C
T <sub>j</sub>	operating junction temperature		–	200	°C

**THERMAL CHARACTERISTICS**

SYMBOL	PARAMETER	CONDITIONS	VALUE	UNIT
R <sub>th j-mb</sub>	thermal resistance from junction to mounting base	P <sub>tot</sub> = 250 W; T <sub>mb</sub> = 25 °C; note 1	0.7	K/W
R <sub>th mb-h</sub>	thermal resistance from mounting base to heatsink		0.2	K/W

**Note**

1. Thermal resistance is determined under specified RF operating conditions.

UHF power transistors

BLV958; BLV958FL

**CHARACTERISTICS**

T<sub>j</sub> = 25 °C unless otherwise specified.

SYMBOL	PARAMETER	CONDITIONS	MIN.	TYP.	MAX.	UNIT
V <sub>(BR)CBO</sub>	collector-base breakdown voltage	open emitter; I <sub>C</sub> = 60 mA	70	–	–	V
V <sub>(BR)CEO</sub>	collector-emitter breakdown voltage	open base; I <sub>C</sub> = 150 mA	30	–	–	V
V <sub>(BR)EBO</sub>	emitter-base breakdown voltage	open collector; I <sub>E</sub> = 3 mA	3	–	–	V
I <sub>CES</sub>	collector leakage current	V <sub>BE</sub> = 0; V <sub>CE</sub> = 28 V	–	–	5	mA
h <sub>FE</sub>	DC current gain	V <sub>CE</sub> = 10 V; I <sub>C</sub> = 4.5 A; note 1; see Fig 3	30	–	120	
C <sub>c</sub>	collector capacitance	V <sub>CB</sub> = 26 V; I <sub>E</sub> = i <sub>e</sub> = 0; f = 1 MHz; note 2; see Fig 4	–	75	–	pF

**Notes**

1. Measured under pulsed conditions: t<sub>p</sub> ≤ 500 μs; δ ≤ 0.01.
2. Value of C<sub>c</sub> is that of the die only, it is not measurable because of internal matching network.

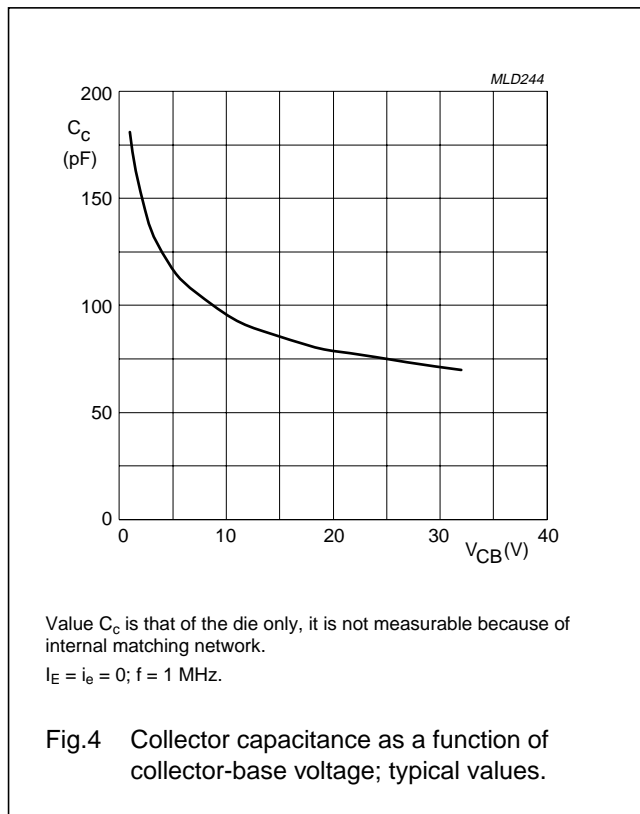
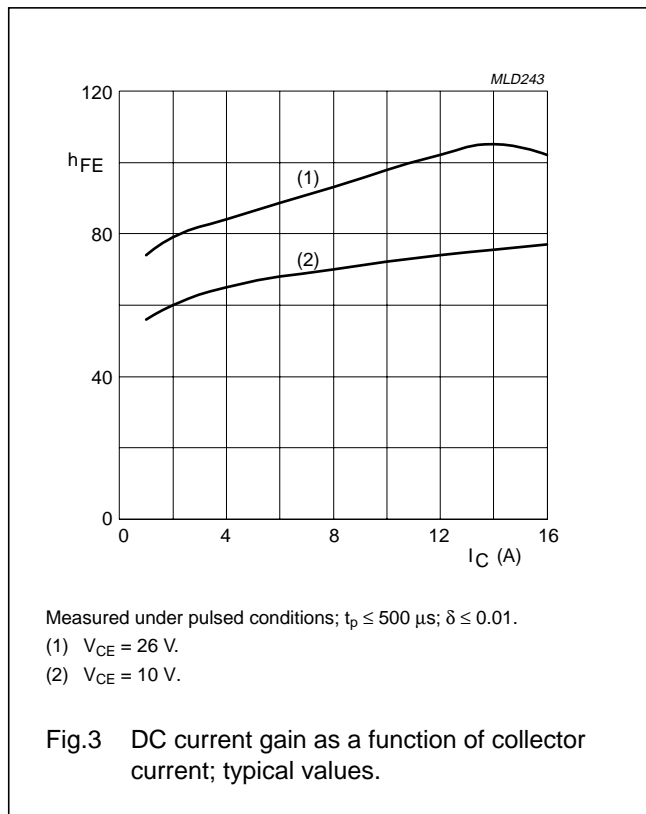

UHF power transistors

BLV958; BLV958FL

**APPLICATION INFORMATION**

RF performance at  $T_h = 25\text{ }^\circ\text{C}$  in a common emitter, class-AB test circuit;  $R_{th\ mb-h} = 0.2\text{ K/W}$ .

MODE OF OPERATION	f (MHz)	V <sub>CE</sub> (V)	I <sub>CQ</sub> (mA)	P <sub>L</sub> (W)	G <sub>p</sub> (dB)	η <sub>c</sub> (%)
CW, class-AB	900	26	200	75	≥8 typ. 9.5	≥50 typ. 55
	960	26	200	75	≥8.5 typ. 9.5	≥50 typ. 55

**Ruggedness in class-AB operation**

The transistors are capable of withstanding a load mismatch corresponding to VSWR = 4 : 1 through all phases at rated output power, under the following conditions: V<sub>CE</sub> = 26 V; f = 960 MHz; I<sub>CQ</sub> = 200 mA; T<sub>h</sub> = 25 °C; R<sub>th mb-h</sub> = 0.2 K/W.

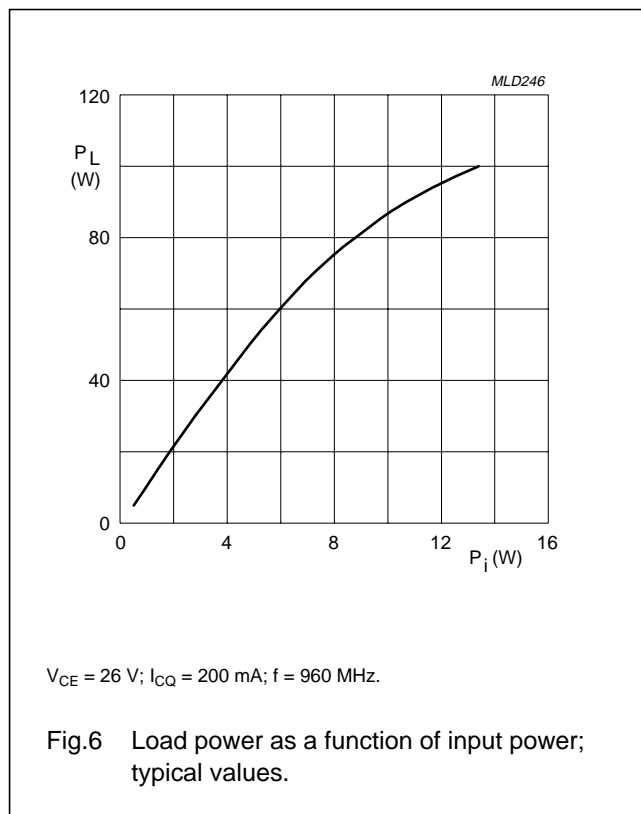
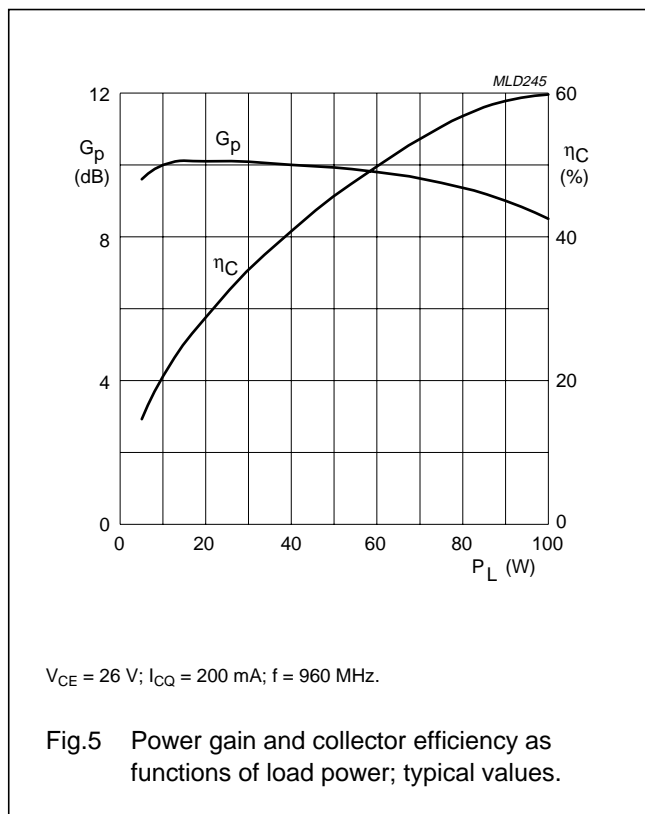

## UHF power transistors

## BLV958; BLV958FL

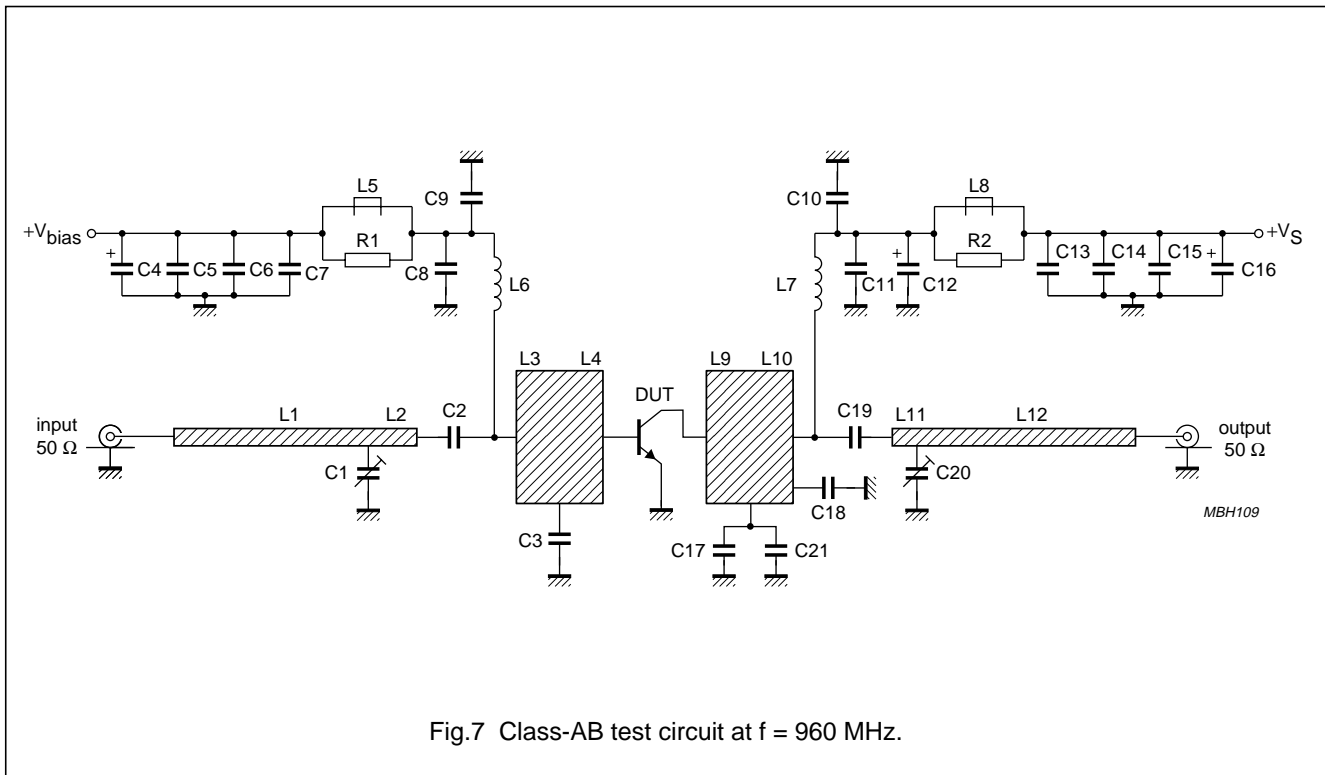

## List of components (see Figs 7 and 8)

COMPONENT	DESCRIPTION	VALUE	DIMENSIONS	CATALOGUE No.
C1, C20	Tekelec, type 5201	0.8 to 10 pF		
C2, C19	multilayer ceramic chip capacitor; note 1	15 pF; 500 V		
C3	multilayer ceramic chip capacitor; note 1	6.2 pF; 500 V		
C4	electrolytic capacitor	10 $\mu$ F; 63 V		
C5	multilayer ceramic chip capacitor	22 nF; 50 V		
C6	multilayer ceramic chip capacitor; note 1	1 nF; 500 V		
C7	multilayer ceramic chip capacitor; note 1	33 pF; 500 V		2222 030 28109
C8, C11, C14	multilayer ceramic chip capacitor; note 1	100 pF; 500 V		
C9, C10, C13	multilayer ceramic chip capacitor; note 1	20 pF; 500 V		
C12	solid tantalum capacitor	1 $\mu$ F; 35 V		
C15	multilayer ceramic chip capacitor	100 nF; 50 V		
C16	electrolytic capacitor	47 $\mu$ F; 40 V		2222 036 68479

## UHF power transistors

## BLV958; BLV958FL

COMPONENT	DESCRIPTION	VALUE	DIMENSIONS	CATALOGUE No.
C17	multilayer ceramic chip capacitor; note 1	4.7 pF; 500 V		
C18	multilayer ceramic chip capacitor; note 1	3.3 pF; 500 V		
C21	multilayer ceramic chip capacitor; note 1	2.7 pF; 500 V		
L1	stripline; note 2		length 51 mm width 2.2 mm	
L2	stripline; note 2		length 7 mm width 2.2 mm	
L3	stripline; note 2		length 5.5 mm width 20 mm	
L4	stripline; note 2		length 9 mm width 20 mm	
L5, L8	Ferroxcube chip-bead grade 4S2			4330 030 36300
L6	5 turns enamelled 1 mm copper wire		int. diameter 4 mm close wound	
L7	4 turns enamelled 1 mm copper wire		int. diameter 4 mm close wound	
L9	stripline; note 2		length 12.5 mm width 20 mm	
L10	stripline; note 2		length 2 mm width 20 mm	
L11	stripline; note 2		length 17 mm width 2.2 mm	
L12	stripline; note 2		length 41 mm width 2.2 mm	
R1, R2	metal film resistor	100 $\Omega$ ; 0.4 W		

**Notes**

1. American Technical Ceramics type 100B or capacitor of same quality.
2. The striplines are on double-clad printed-circuit board with PTFE fibre-glass dielectric ( $\epsilon_r = 2.25$ ); thickness  $\frac{1}{32}$  inch.

UHF power transistors

BLV958; BLV958FL

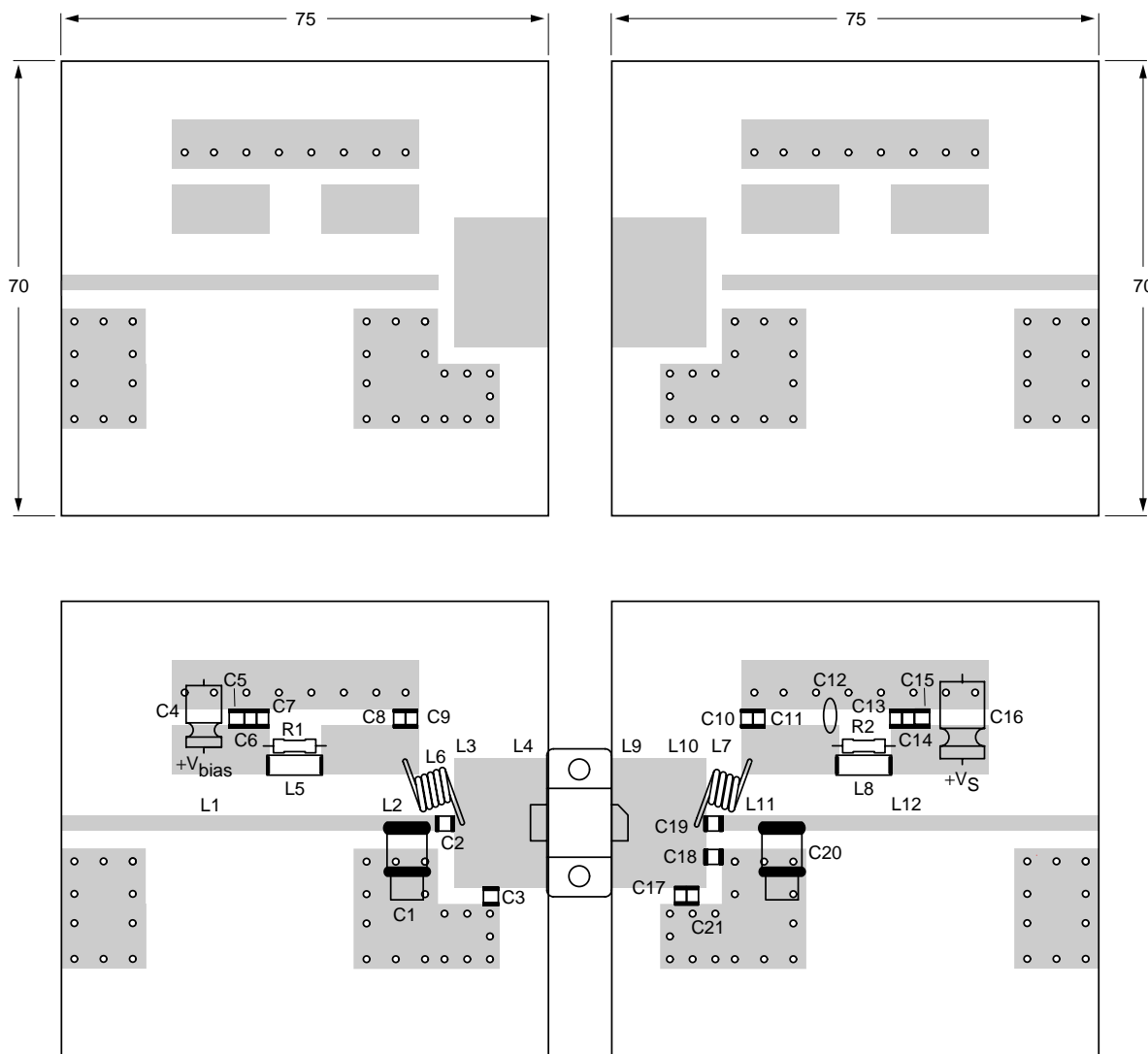

MBH110

The same printed-circuit board can also be used for the flangeless version FL.

Dimensions in mm.

The components are located on one side of the copper-clad PTFE microfibre-glass board, the other side is unetched and serves as a ground plane. Earth connections from the component side to the ground plane are made by through metallization.

Fig.8 Component layout and printed-circuit board for 960 MHz class-AB test circuit.



UHF power transistors

BLV958; BLV958FL

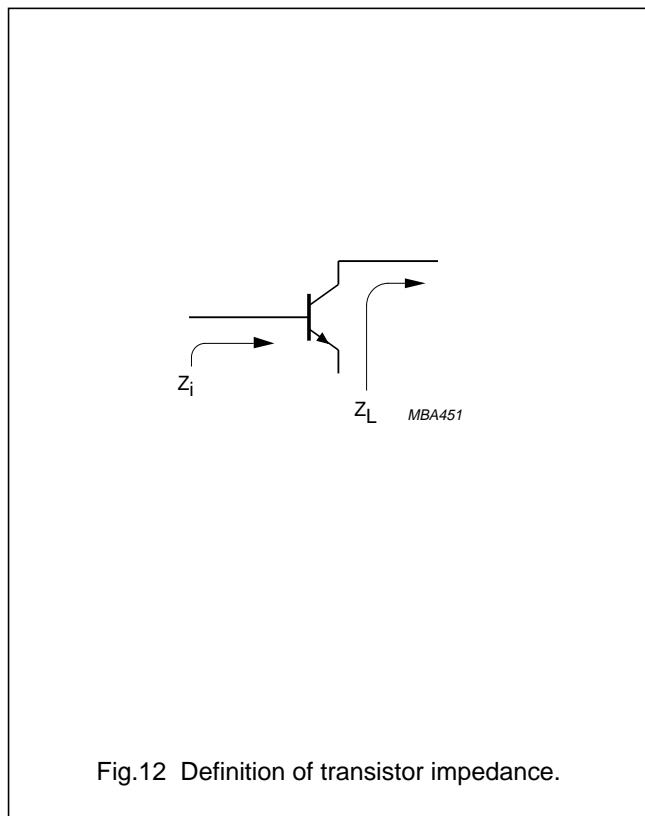
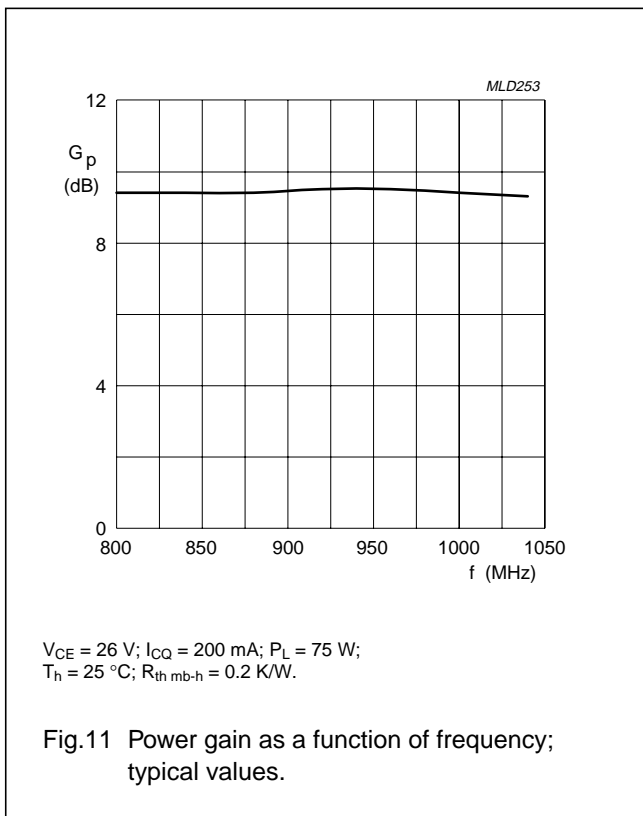
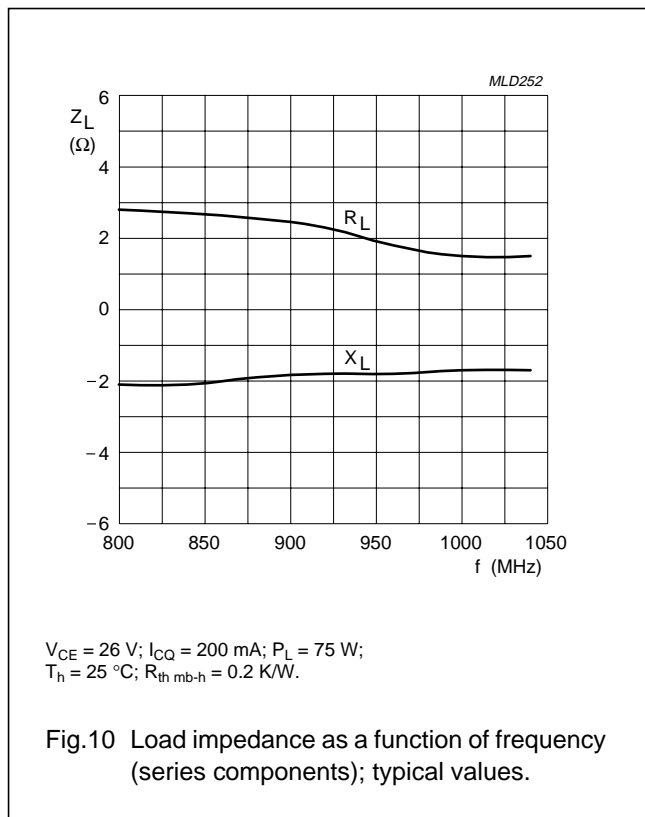
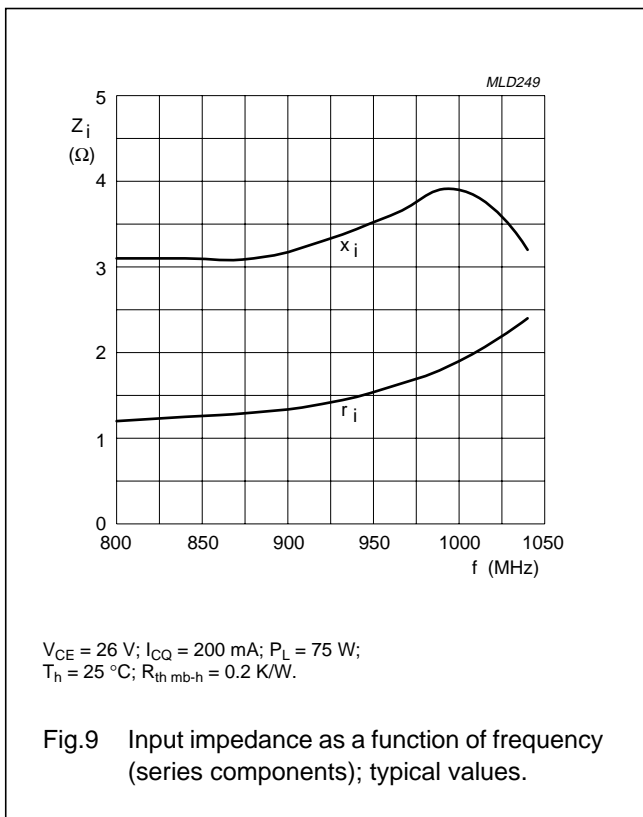

UHF power transistors

BLV958; BLV958FL

PACKAGE OUTLINES

Flanged ceramic package; 2 mounting holes; 2 leads

SOT391A

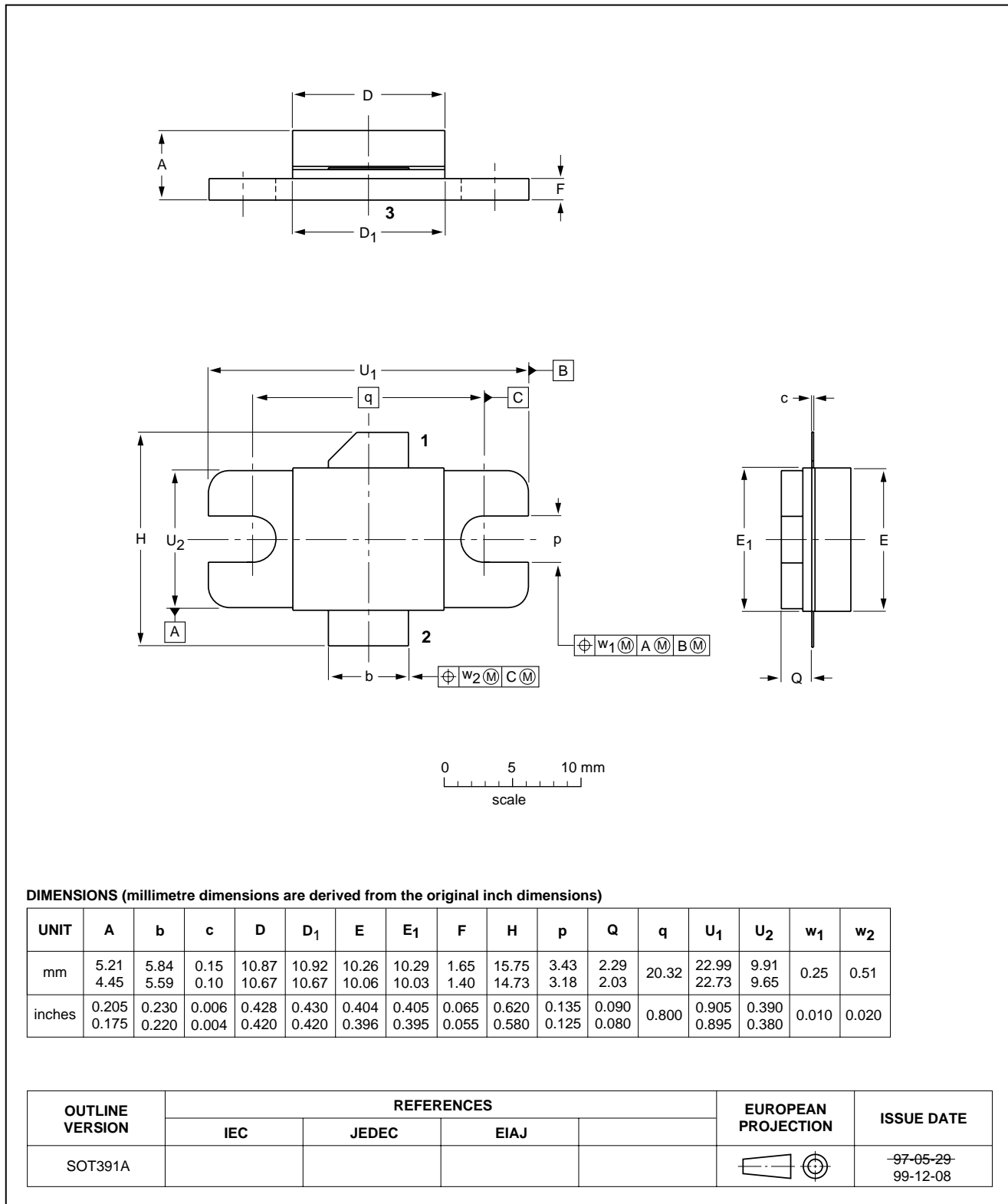

UHF power transistors

BLV958; BLV958FL

Flangeless ceramic package; 2 leads

SOT391B

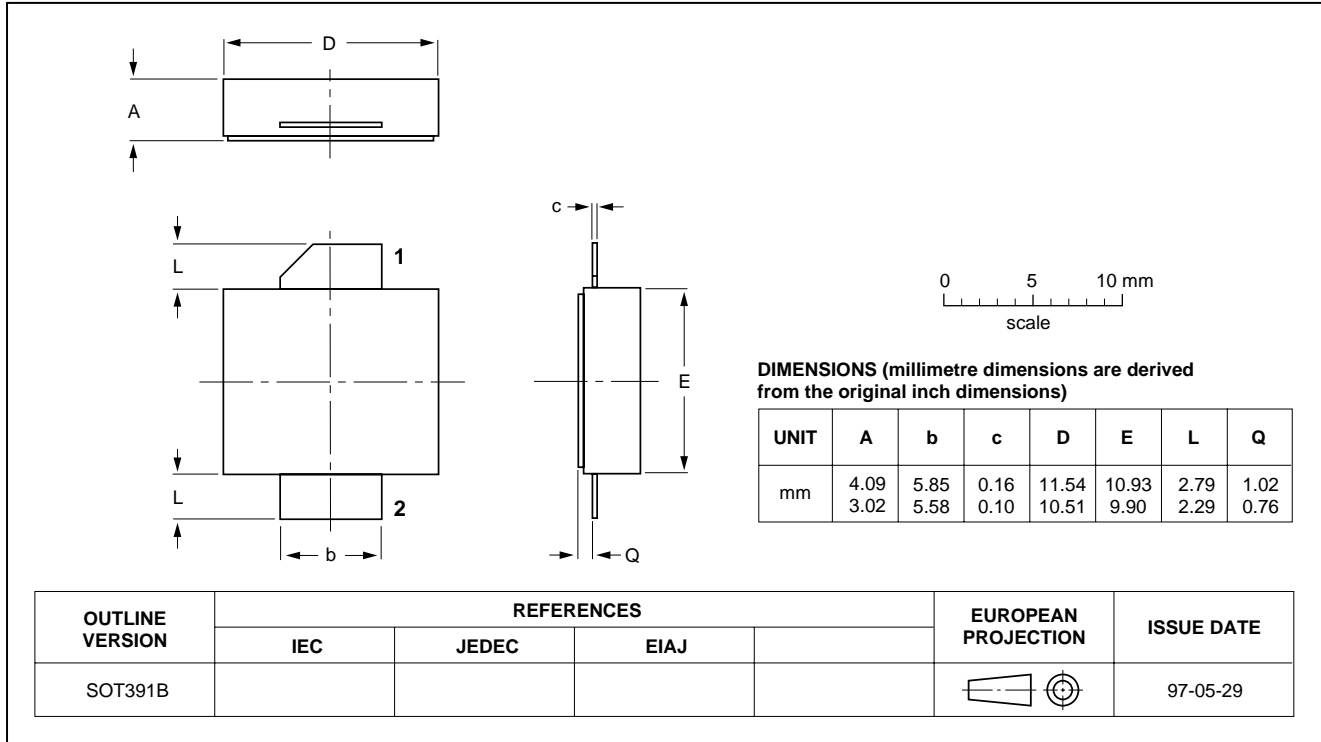

DEFINITIONS

<b>Data sheet status</b>	
Objective specification	This data sheet contains target or goal specifications for product development.
Preliminary specification	This data sheet contains preliminary data; supplementary data may be published later.
Product specification	This data sheet contains final product specifications.
<b>Limiting values</b>	
Limiting values given are in accordance with the Absolute Maximum Rating System (IEC 134). Stress above one or more of the limiting values may cause permanent damage to the device. These are stress ratings only and operation of the device at these or at any other conditions above those given in the Characteristics sections of the specification is not implied. Exposure to limiting values for extended periods may affect device reliability.	
<b>Application information</b>	
Where application information is given, it is advisory and does not form part of the specification.	

LIFE SUPPORT APPLICATIONS

These products are not designed for use in life support appliances, devices, or systems where malfunction of these products can reasonably be expected to result in personal injury. Philips customers using or selling these products for use in such applications do so at their own risk and agree to fully indemnify Philips for any damages resulting from such improper use or sale.

# Philips Semiconductors – a worldwide company

**Argentina:** see South America

**Australia:** 3 Figtree Drive, HOMEBUSH, NSW 2140,  
Tel. +61 2 9704 8141, Fax. +61 2 9704 8139

**Austria:** Computerstr. 6, A-1101 WIEN, P.O. Box 213,  
Tel. +43 1 60 101 1248, Fax. +43 1 60 101 1210

**Belarus:** Hotel Minsk Business Center, Bld. 3, r. 1211, Volodarski Str. 6,  
220050 MINSK, Tel. +375 172 20 0733, Fax. +375 172 20 0773

**Belgium:** see The Netherlands

**Brazil:** see South America

**Bulgaria:** Philips Bulgaria Ltd., Energoproject, 15th floor,  
51 James Bourchier Blvd., 1407 SOFIA,  
Tel. +359 2 68 9211, Fax. +359 2 68 9102

**Canada:** PHILIPS SEMICONDUCTORS/COMPONENTS,  
Tel. +1 800 234 7381, Fax. +1 800 943 0087

**China/Hong Kong:** 501 Hong Kong Industrial Technology Centre,  
72 Tat Chee Avenue, Kowloon Tong, HONG KONG,  
Tel. +852 2319 7888, Fax. +852 2319 7700

**Colombia:** see South America

**Czech Republic:** see Austria

**Denmark:** Sydhavnsgade 23, 1780 COPENHAGEN V,  
Tel. +45 33 29 3333, Fax. +45 33 29 3905

**Finland:** Sinikalliontie 3, FIN-02630 ESPOO,  
Tel. +358 9 615 800, Fax. +358 9 6158 0920

**France:** 51 Rue Carnot, BP317, 92156 SURESNES Cedex,  
Tel. +33 1 4099 6161, Fax. +33 1 4099 6427

**Germany:** Hammerbrookstraße 69, D-20097 HAMBURG,  
Tel. +49 40 2353 60, Fax. +49 40 2353 6300

**Hungary:** see Austria

**India:** Philips INDIA Ltd, Band Box Building, 2nd floor,  
254-D, Dr. Annie Besant Road, Worli, MUMBAI 400 025,  
Tel. +91 22 493 8541, Fax. +91 22 493 0966

**Indonesia:** PT Philips Development Corporation, Semiconductors Division,  
Gedung Philips, Jl. Buncit Raya Kav.99-100, JAKARTA 12510,  
Tel. +62 21 794 0040 ext. 2501, Fax. +62 21 794 0080

**Ireland:** Newstead, Clonskeagh, DUBLIN 14,  
Tel. +353 1 7640 000, Fax. +353 1 7640 200

**Israel:** RAPAC Electronics, 7 Kehilat Saloniki St, PO Box 18053,  
TEL AVIV 61180, Tel. +972 3 645 0444, Fax. +972 3 649 1007

**Italy:** PHILIPS SEMICONDUCTORS, Via Casati, 23 - 20052 MONZA (MI),  
Tel. +39 039 203 6838, Fax +39 039 203 6800

**Japan:** Philips Bldg 13-37, Kohnan 2-chome, Minato-ku,  
TOKYO 108-8507, Tel. +81 3 3740 5130, Fax. +81 3 3740 5057

**Korea:** Philips House, 260-199 Itaewon-dong, Yongsan-ku, SEOUL,  
Tel. +82 2 709 1412, Fax. +82 2 709 1415

**Malaysia:** No. 76 Jalan Universiti, 46200 PETALING JAYA, SELANGOR,  
Tel. +60 3 750 5214, Fax. +60 3 757 4880

**Mexico:** 5900 Gateway East, Suite 200, EL PASO, TEXAS 79905,  
Tel. +9-5 800 234 7381, Fax +9-5 800 943 0087

**Middle East:** see Italy

**Netherlands:** Postbus 90050, 5600 PB EINDHOVEN, Bldg. VB,  
Tel. +31 40 27 82785, Fax. +31 40 27 88399

**New Zealand:** 2 Wagener Place, C.P.O. Box 1041, AUCKLAND,  
Tel. +64 9 849 4160, Fax. +64 9 849 7811

**Norway:** Box 1, Manglerud 0612, OSLO,  
Tel. +47 22 74 8000, Fax. +47 22 74 8341

**Pakistan:** see Singapore

**Philippines:** Philips Semiconductors Philippines Inc.,  
106 Valero St. Salcedo Village, P.O. Box 2108 MCC, MAKATI,  
Metro MANILA, Tel. +63 2 816 6380, Fax. +63 2 817 3474

**Poland:** Al.Jerozolimskie 195 B, 02-222 WARSAW,  
Tel. +48 22 5710 000, Fax. +48 22 5710 001

**Portugal:** see Spain

**Romania:** see Italy

**Russia:** Philips Russia, Ul. Usatcheva 35A, 119048 MOSCOW,  
Tel. +7 095 755 6918, Fax. +7 095 755 6919

**Singapore:** Lorong 1, Toa Payoh, SINGAPORE 319762,  
Tel. +65 350 2538, Fax. +65 251 6500

**Slovakia:** see Austria

**Slovenia:** see Italy

**South Africa:** S.A. PHILIPS Pty Ltd., 195-215 Main Road Martindale,  
2092 JOHANNESBURG, P.O. Box 58088 Newville 2114,  
Tel. +27 11 471 5401, Fax. +27 11 471 5398

**South America:** Al. Vicente Pinzon, 173, 6th floor,  
04547-130 SÃO PAULO, SP, Brazil,  
Tel. +55 11 821 2333, Fax. +55 11 821 2382

**Spain:** Balmes 22, 08007 BARCELONA,  
Tel. +34 93 301 6312, Fax. +34 93 301 4107

**Sweden:** Kottbygatan 7, Akalla, S-16485 STOCKHOLM,  
Tel. +46 8 5985 2000, Fax. +46 8 5985 2745

**Switzerland:** Allmendstrasse 140, CH-8027 ZÜRICH,  
Tel. +41 1 488 2741 Fax. +41 1 488 3263

**Taiwan:** Philips Semiconductors, 6F, No. 96, Chien Kuo N. Rd., Sec. 1,  
TAIPEI, Taiwan Tel. +886 2 2134 2886, Fax. +886 2 2134 2874

**Thailand:** PHILIPS ELECTRONICS (THAILAND) Ltd.,  
209/2 Sanpavuth-Bangna Road Prakanong, BANGKOK 10260,  
Tel. +66 2 745 4090, Fax. +66 2 398 0793

**Turkey:** Yukari Dudullu, Org. San. Blg., 2.Cad. Nr. 28 81260 Umraniye,  
ISTANBUL, Tel. +90 216 522 1500, Fax. +90 216 522 1813

**Ukraine:** PHILIPS UKRAINE, 4 Patrice Lumumba str., Building B, Floor 7,  
252042 KIEV, Tel. +380 44 264 2776, Fax. +380 44 268 0461

**United Kingdom:** Philips Semiconductors Ltd., 276 Bath Road, Hayes,  
MIDDLESEX UB3 5BX, Tel. +44 208 730 5000, Fax. +44 208 754 8421

**United States:** 811 East Arques Avenue, SUNNYVALE, CA 94088-3409,  
Tel. +1 800 234 7381, Fax. +1 800 943 0087

**Uruguay:** see South America

**Vietnam:** see Singapore

**Yugoslavia:** PHILIPS, Trg N. Pasica 5/v, 11000 BEOGRAD,  
Tel. +381 11 3341 299, Fax.+381 11 3342 553

**For all other countries apply to:** Philips Semiconductors,  
International Marketing & Sales Communications, Building BE-p, P.O. Box 218,  
5600 MD EINDHOVEN, The Netherlands, Fax. +31 40 27 24825

**Internet:** <http://www.semiconductors.philips.com>

© Philips Electronics N.V. 2000

SCA 69

All rights are reserved. Reproduction in whole or in part is prohibited without the prior written consent of the copyright owner.

The information presented in this document does not form part of any quotation or contract, is believed to be accurate and reliable and may be changed without notice. No liability will be accepted by the publisher for any consequence of its use. Publication thereof does not convey nor imply any license under patent- or other industrial or intellectual property rights.

Printed in The Netherlands

125002/04/pp12

Date of release: 2000 Jan 12

Document order number: 9397 750 06671

*Let's make things better.*

**Philips  
Semiconductors**

SUNSTAR自动化 <http://www.sensor-ic.com/> TEL: 0755-83376489 FAX: 0755-83376182 E-MAIL: szss20@163.com



**PHILIPS**