

# **OKI** electronic components

---

## **OPU850CP, OPU852CP**

---

### **LED Capsule**

---

#### **GENERAL DESCRIPTION**

The OPU850CP, and OPU852CP are sensors that are most suited to paper detection. For superior dustproof packaging and easy mounting, a phototransistor can be sealed (encapsulated) into a package with connectors.

The OPU852CP can be mounted with a space (200mm) between the device and the LED capsule because the device has a non-spherical surface lens.

The OPU850CP and OPU852CP assure a high quality because they have been assembled without soldering or using adhesive.

#### **FEATURES**

- The light axis is positioned for efficient insertion into LED capsules and photo capsules.
- The sensor unit element is protected from dust.
- The assembly and mount are easy (without soldering).

#### **APPLICATIONS**

- Banking terminals (ATM, etc.)
- Printers
- Copying machines
- Communications terminals (FAX, etc.)

**PIN CONFIGURATION**

- OPU850CP, OPU852CP

(Unit: mm)

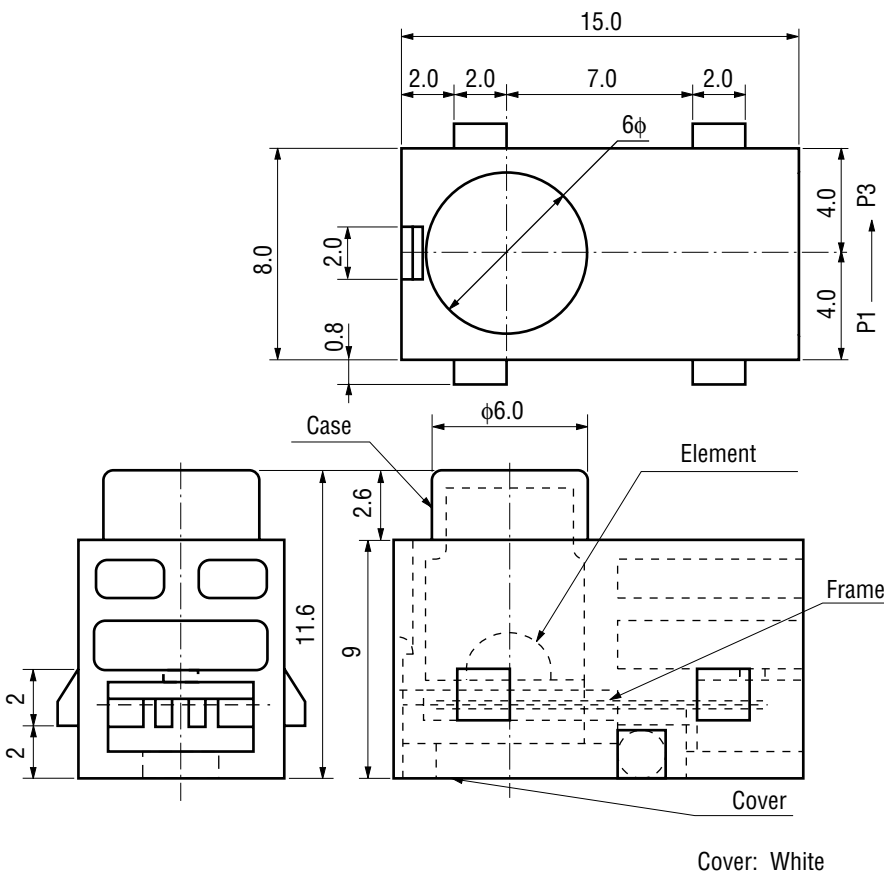

- Pin Connection Diagram  
(P No. indicates the pin number of connectors.)

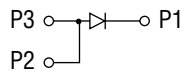

P2 , P3: Anode  
P1 : Cathode

## ABSOLUTE MAXIMUM RATINGS

Parameter	Symbol	Test Condition	Rating		Unit	Note
			OPU850CP	OPU852CP		
Temperature Storage	$T_{stg}$	—	-10 to +60		°C	—
Operating Temperature	$T_{opr}$	—	-10 to +60		°C	—
DC Forward Current	$I_F$	Ta=25°C	60		mA	—
DC Forward Current Derating Factor	—		1.7		mA/°C	Ta=25°C or more
Pulse Forward Current	$I_{FRM}$		0.5		A	tw=100 μs, T=10 ms
Pulse Forward Current Derating Factor	—		14.3		mA/°C	Ta=25°C or more
Reverse Voltage	$V_R$		6		V	—
Power Dissipation	$P_D$		102	120	mW	—

## ELECTRICAL AND OPTICAL CHARACTERISTICS

## • OPU850CP, OPU852CP

(Ambient Temperature Ta=25°C)

Parameter	Symbol	Condition	OPU850CP			OPU852CP			Unit
			Min.	Typ.	Max.	Min.	Typ.	Max.	
Forward Voltage	$V_F$	$I_F=60$ mA	—	1.3	1.7	—	1.55	2.0	V
Reverse Current	$I_R$	$V_R=6$ V	—	—	10	—	—	10	μA
Peak-emission Wavelength	$\lambda_P$	$I_F=60$ mA	—	940	—	—	910	—	nm
Output Photocurrent **	$I_{P1}$	$I_F=50$ mA $V_{CE}=1$ V $L^*=50$ mm	0.20	—	3.00	5.5	—	28	mA
	$I_{P2}$	$I_F=50$ mA $V_{CE}=1$ V $L^*=200$ mm	10	—	150	400	—	3000	μA

\* : Distance between sensors

\*\* : Measuring circuit

Measuring circuit

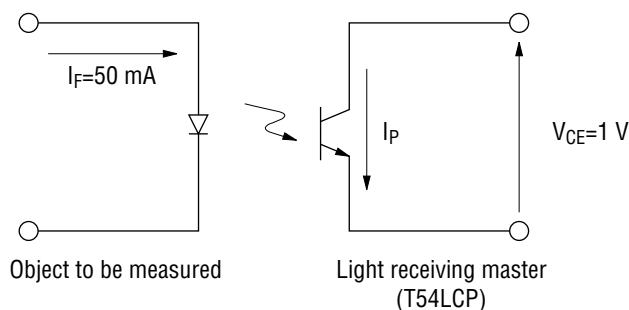

**TYPICAL CHARACTERISTICS**

• **OPU850CP Spectral Distribution**

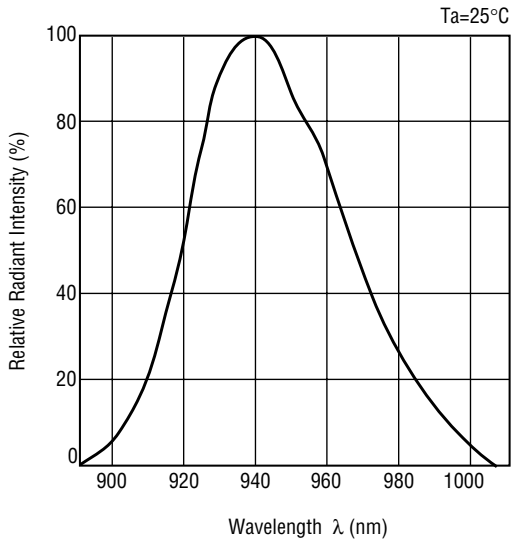

• **OPU852CP Spectral Distribution**

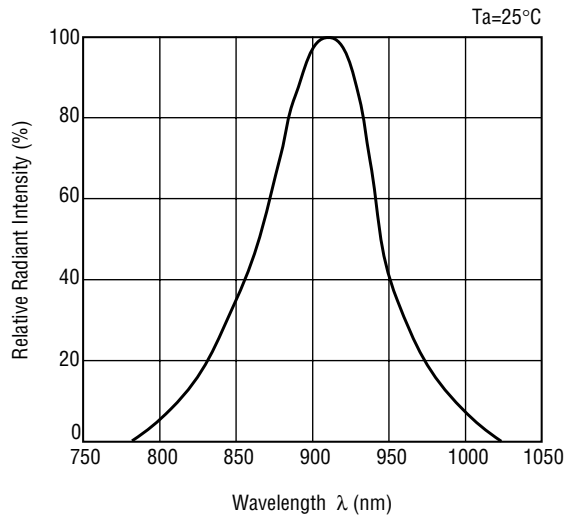

• **OPU850CP Directional Characteristic**

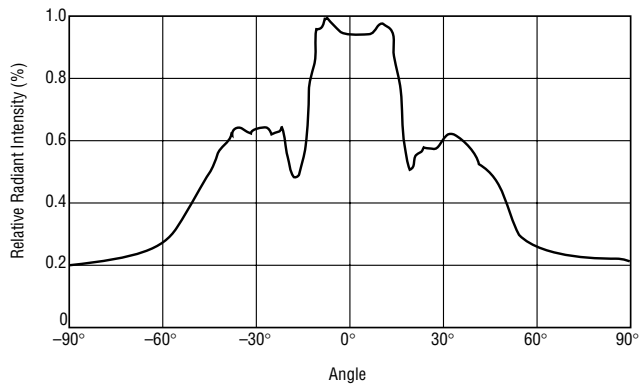

• **OPU852CP Directional Characteristic**

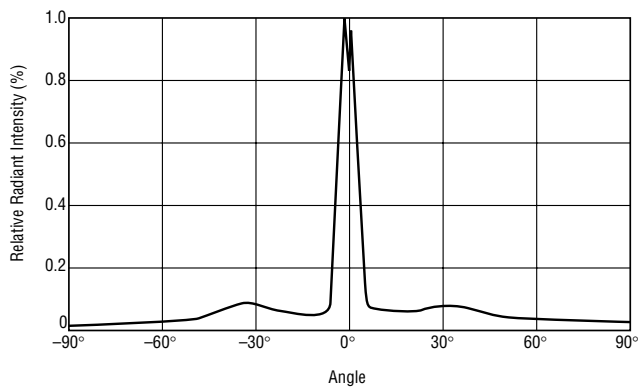

TYPICAL CHARACTERISTIC

- OPU850CP, OPU860CP Switching Time vs. Load Resistance

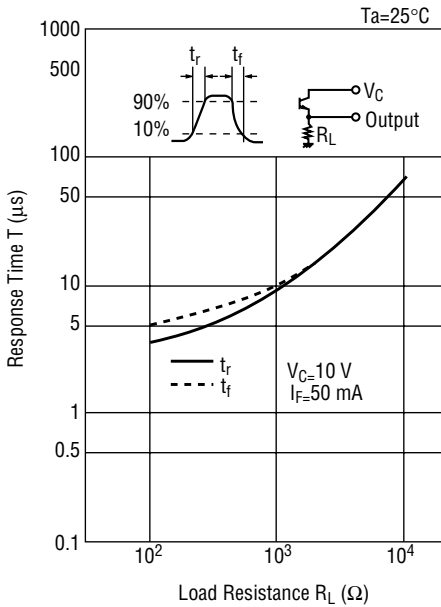

- OPU852CP, OPU860CP Switching Time vs. Load Resistance

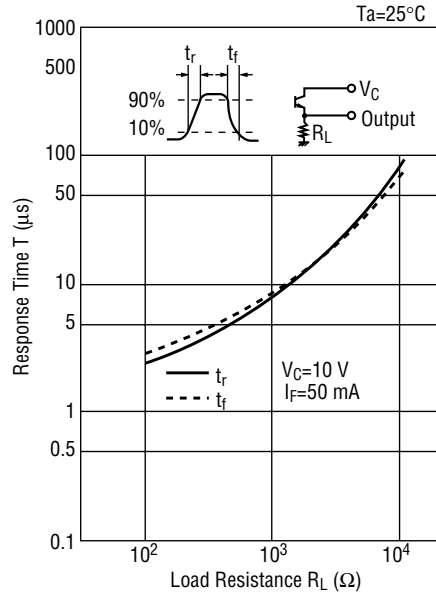

- OPU850CP, OPU862CP Switching Time vs. Load Resistance

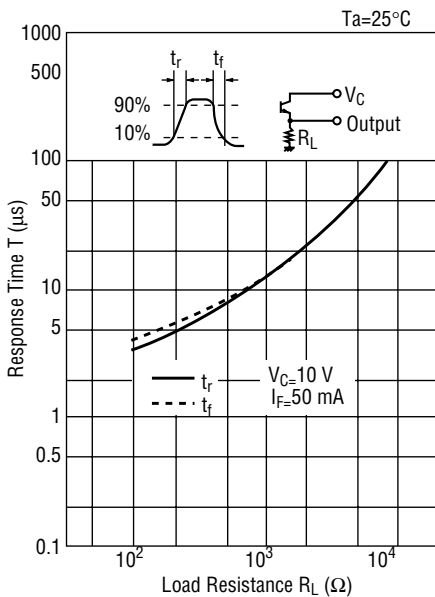

- OPU852CP, OPU862CP Switching Time vs. Load Resistance

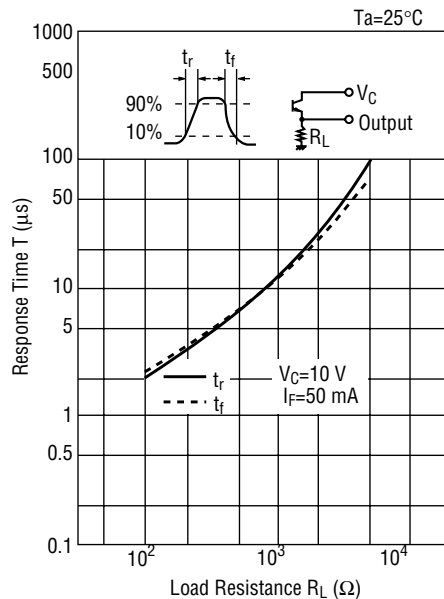

• OPU850CP, OPU852CP Maximum Pulse Forward Current Tolerance

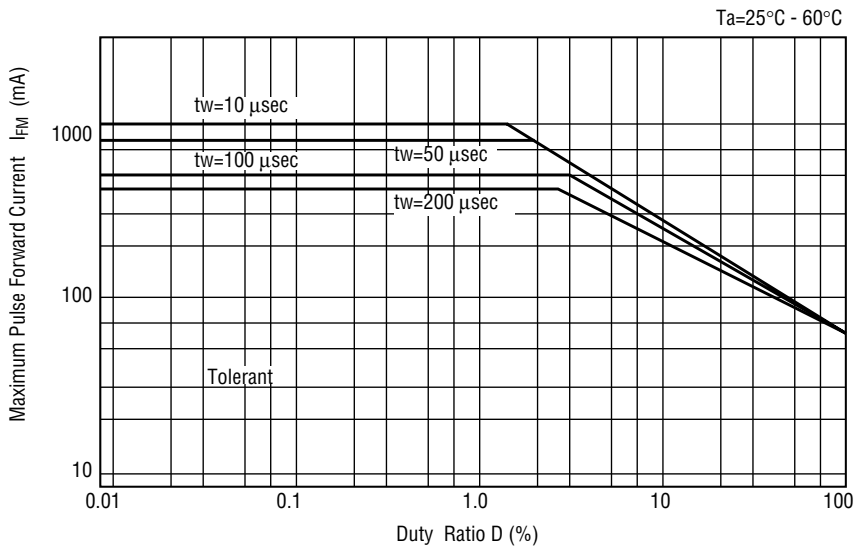

**OPTION PARTS**

• **Sensor Holder A Type Dimension**

(Unit: mm)

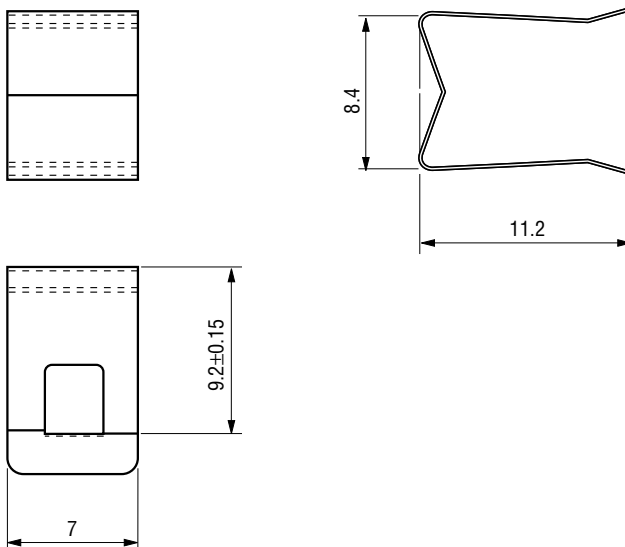

• **Sensor Holder B Type Dimension**

(Unit: mm)

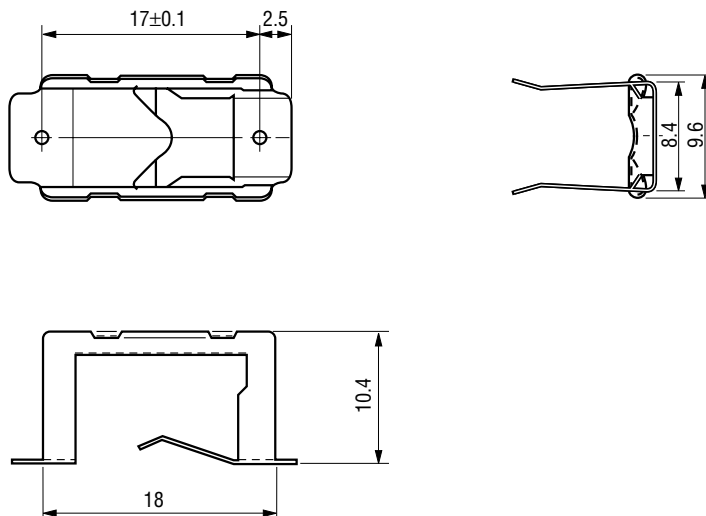

**Recommended Connector for Capsule Sensor (female connector)**

Product Name	Type	Maker
Connector	IL—Y—3S—S15C3	Japan Aviation Electronics Ind., Ltd.