

# OKI electronic components

## KGF1262

### Medium-Power Amplifier

#### GENERAL DESCRIPTION

The KGF1262 is a medium-power amplifier, with frequencies ranging from the UHF-band to the L-band, that features high gain, high output power, and low current operation. The KGF1262 specifications are guaranteed to a fixed matching circuit for 5.2 V and 1.9 GHz; external impedance-matching circuits are also required. Because of the high gain and high output power at the low operating current, the KGF1262 is ideal as a transmitter-driver amplifier for personal handy phones of more than 1.5 GHz band.

#### FEATURES

- High linear gain: 15 dB (min.) at 1.9 GHz
- High output power: 18 dBm (min.) at 1.9 GHz
- Low current operation: 70 mA (max.)
- Self-bias circuit configuration with built-in source capacitor
- package: 4PSOP

#### PACKAGE DIMENSIONS

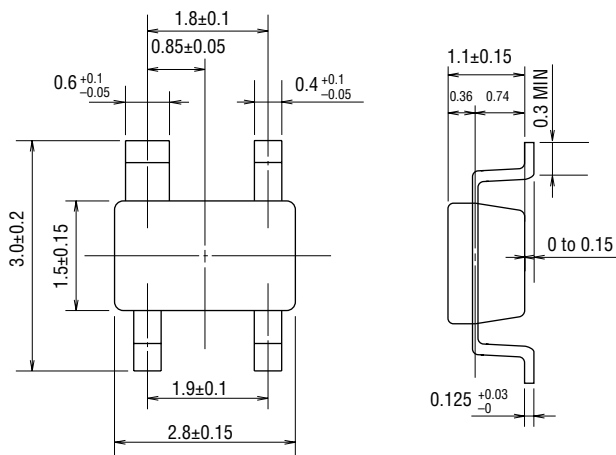

(Unit: mm)

Package material	Epoxy resin
Lead frame material	42 alloy
Pin treatment	Solder plating
Solder plate thickness	5 μm or more

## MARKING

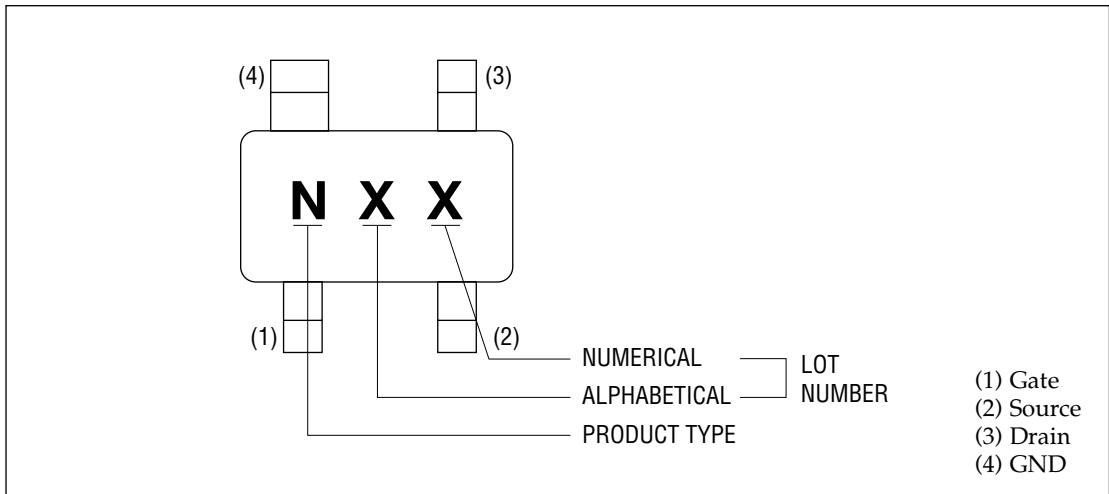

## CIRCUIT

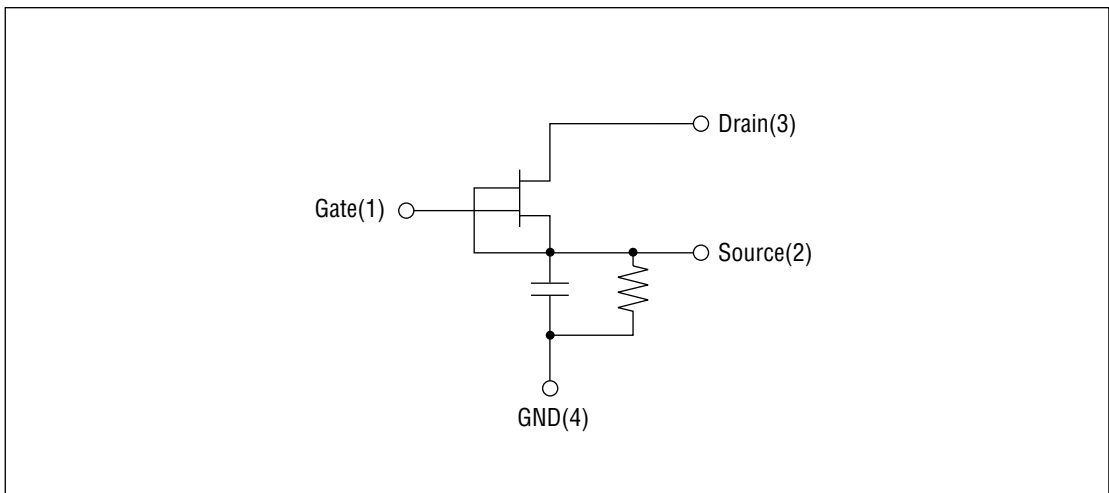

**ABSOLUTE MAXIMUM RATINGS**

Item	Symbol	Condition	Unit	Min.	Max.
Drain-source voltage	$V_{DS}$	$T_a = 25^{\circ}\text{C}$	V	—	10
Gate-source voltage	$V_{GS}$	$T_a = 25^{\circ}\text{C}$	V	-5.0	0.4
Drain current	$I_{DS}$	$T_a = 25^{\circ}\text{C}$	mA	—	360
Total power dissipation	$P_{tot}$	$T_a = 25^{\circ}\text{C}$	mW	—	300
Channel temperature	$T_{ch}$	—	$^{\circ}\text{C}$	—	150
Storage temperature	$T_{stg}$	—	$^{\circ}\text{C}$	-45	125

**ELECTRICAL CHARACTERISTICS**

(Ta = 25°C)

Item	Symbol	Condition	Unit	Min.	Typ.	Max.
Gate-source leakage current	$I_{GSS}$	$V_{GS} = -5\text{ V}$	mA	—	—	0.1
Gate-drain leakage current	$I_{GDO}$	$V_{GD} = -15\text{ V}$	mA	—	—	0.5
Drain-source leakage current	$I_{DS(off)}$	$V_{DS} = 3\text{ V}, V_{GS} = -2.5\text{ V}$	mA	—	—	1.0
Drain current	$I_{DSS}$	$V_{DS} = 3\text{ V}, V_{GS} = 0\text{ V}$	mA	180	—	—
Operating current	$I_D$	(*1), $P_{IN} = 7\text{ dBm}$	mA	—	50.0	70.0
Gate-source cut-off voltage	$V_{GS(off)}$	$V_{DS} = 3\text{ V}, I_{DS} = 720\text{ }\mu\text{A}$	$\mu\text{A}$	-2.0	—	-1.0
Transconductance	$g_m$	$V_{DS} = 3\text{ V}, I_{DS} = 60\text{ mA}$	mS	100	—	—
Linear gain	$G_{LIN}$	(*1), $P_{IN} = -10\text{ dBm}$	dB	15.0	16.5	—
Output power	$P_O$	(*1), $P_{IN} = 7\text{ dBm}$	dBm	18.0	20.0	—

\*1 Self-bias condition:  $V_{DD} = 5\text{ V} \pm 0.25\text{ V}$ ,  $V_G = 0\text{ V}$ ,  $f = 1.9\text{ GHz}$

**RF CHARACTERISTICS**

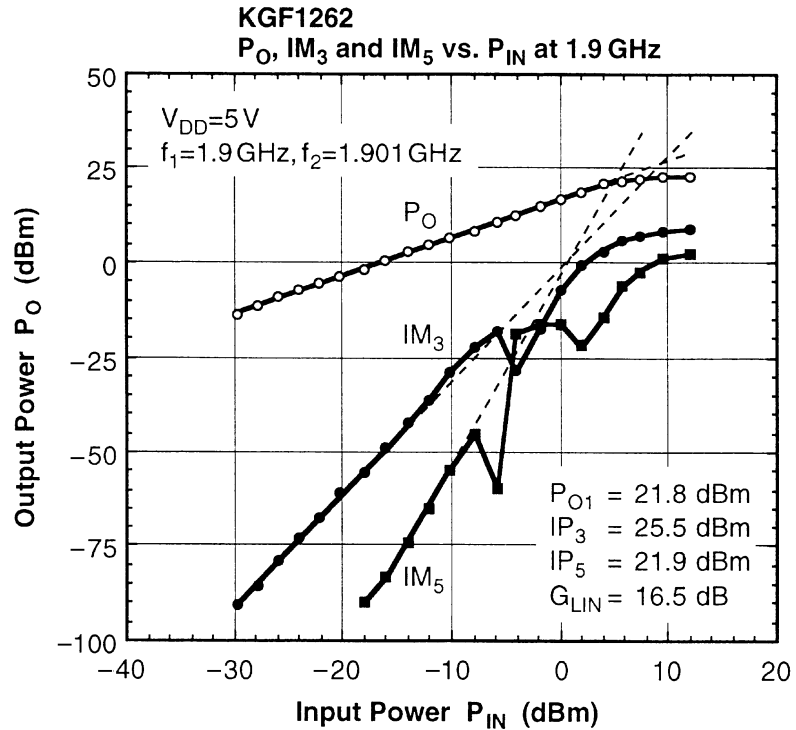
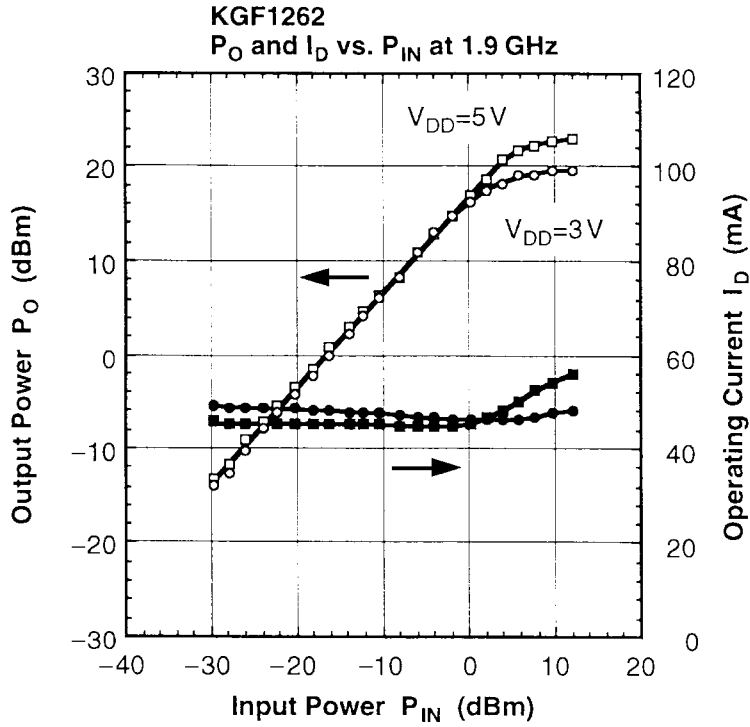

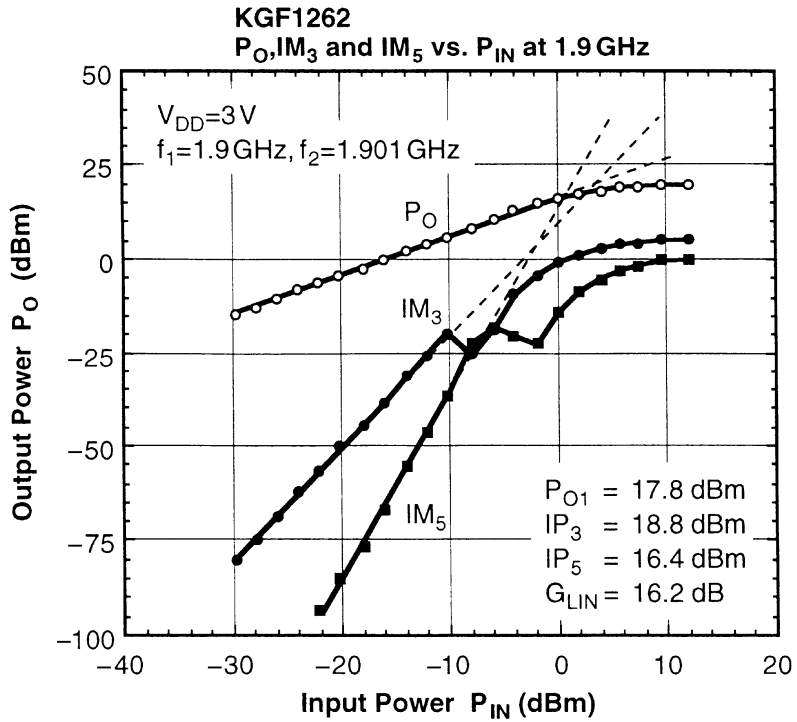

## Typical S Parameters

 $V_{DD} = 5\text{ V}$ ,  $V_G = 0\text{ V}$ ,  $I_D = 45.4\text{ mA}$ 

Freq(MHz)	MAG(S <sub>11</sub> )	ANG(S <sub>11</sub> )	MAG(S <sub>21</sub> )	ANG(S <sub>21</sub> )	MAG(S <sub>12</sub> )	ANG(S <sub>12</sub> )	MAG(S <sub>22</sub> )	ANG(S <sub>22</sub> )
500.0	0.861	-43.20	8.314	132.26	0.023	81.74	0.708	-20.18
600.0	0.885	-46.52	7.319	131.88	0.032	73.96	0.740	-23.72
700.0	0.938	-53.35	7.176	131.57	0.035	68.04	0.739	-29.36
800.0	0.969	-62.62	7.448	127.57	0.038	58.11	0.724	-34.75
900.0	0.972	-72.43	7.617	121.79	0.041	59.61	0.693	-39.17
1000.0	0.942	-82.27	7.566	113.36	0.037	52.91	0.657	-42.84
1100.0	0.907	-91.58	7.454	105.56	0.038	55.56	0.630	-44.99
1200.0	0.852	-99.25	7.080	97.79	0.037	61.75	0.610	-46.73
1300.0	0.804	-105.78	6.706	91.46	0.038	66.19	0.599	-48.16
1400.0	0.756	-112.04	6.346	85.32	0.038	75.05	0.591	-49.34
1500.0	0.718	-116.78	6.004	79.92	0.040	78.36	0.584	-51.27
1600.0	0.681	-121.54	5.672	74.96	0.046	85.13	0.589	-52.35
1700.0	0.654	-125.66	5.394	70.48	0.052	88.18	0.588	-54.02
1800.0	0.631	-129.73	5.093	65.90	0.057	93.35	0.594	-56.54
1900.0	0.618	-133.88	4.889	61.24	0.064	95.49	0.598	-59.04
2000.0	0.603	-137.40	4.659	57.66	0.074	95.70	0.605	-60.99
2100.0	0.594	-140.49	4.501	53.61	0.083	94.46	0.614	-63.71
2200.0	0.585	-143.89	4.321	50.05	0.095	94.21	0.619	-66.74
2300.0	0.581	-146.80	4.179	46.29	0.107	96.61	0.624	-69.08
2400.0	0.582	-150.18	4.056	42.23	0.117	94.20	0.628	-72.55
2500.0	0.578	-152.79	3.902	38.65	0.128	92.99	0.643	-76.40
2600.0	0.581	-156.41	3.786	35.05	0.143	91.07	0.646	-80.05
2700.0	0.587	-158.85	3.685	31.84	0.156	89.38	0.662	-83.66
2800.0	0.592	-161.90	3.578	27.91	0.171	88.38	0.668	-86.20
2900.0	0.597	-164.17	3.502	25.03	0.185	87.34	0.683	-91.62
3000.0	0.611	-167.83	3.398	20.74	0.202	84.36	0.696	-96.08

### Typical S Parameters

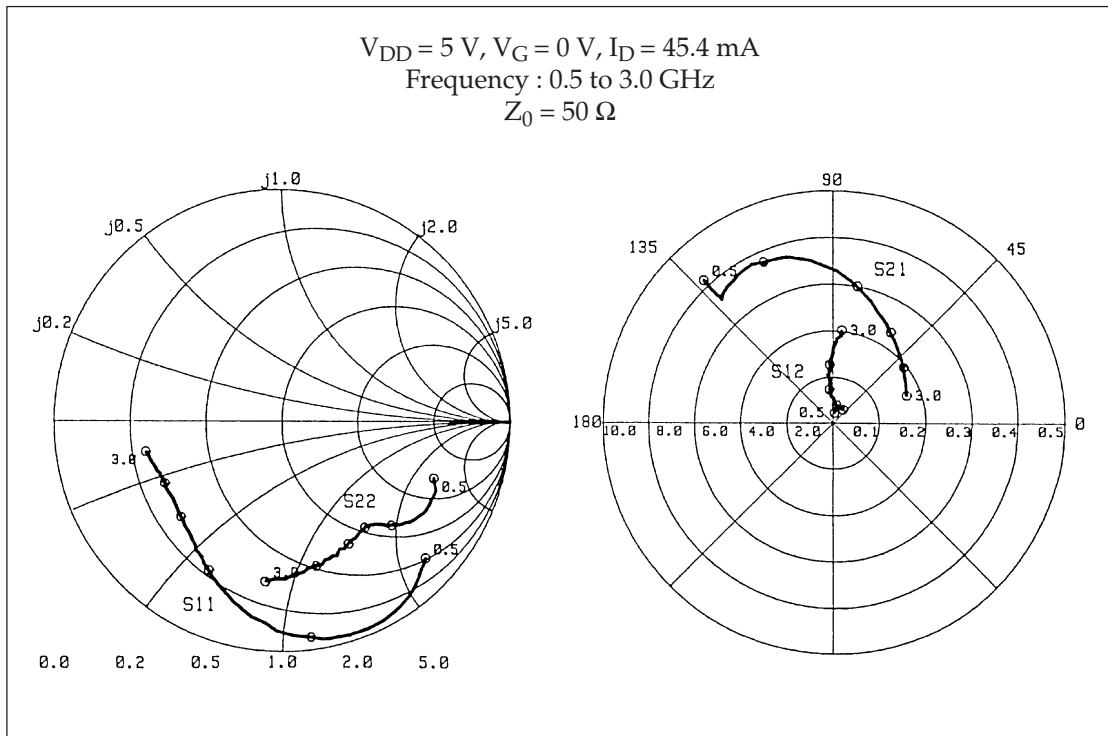

## Typical S Parameters

 $V_{DD} = 3\text{ V}$ ,  $V_G = 0\text{ V}$ ,  $I_D = 48.5\text{ mA}$ 

Freq(MHz)	MAG(S <sub>11</sub> )	ANG(S <sub>11</sub> )	MAG(S <sub>21</sub> )	ANG(S <sub>21</sub> )	MAG(S <sub>12</sub> )	ANG(S <sub>12</sub> )	MAG(S <sub>22</sub> )	ANG(S <sub>22</sub> )
500.0	0.916	-43.51	6.335	140.34	0.027	98.55	0.457	-4.57
600.0	0.927	-48.23	5.762	139.83	0.039	83.96	0.498	-8.99
700.0	0.964	-54.71	5.580	136.14	0.042	75.40	0.502	-19.93
800.0	0.993	-63.63	5.892	132.31	0.043	69.15	0.515	-24.18
900.0	1.005	-72.69	5.909	126.70	0.048	69.44	0.483	-28.86
1000.0	0.987	-82.39	6.026	117.94	0.047	65.48	0.493	-33.12
1100.0	0.967	-91.73	5.982	111.07	0.051	67.55	0.477	-34.38
1200.0	0.920	-99.80	5.754	101.93	0.053	67.95	0.490	-39.74
1300.0	0.876	-107.04	5.571	95.56	0.055	70.09	0.495	-41.60
1400.0	0.836	-113.69	5.299	88.68	0.059	72.60	0.498	-45.70
1500.0	0.797	-119.30	5.086	82.78	0.060	73.94	0.501	-49.18
1600.0	0.763	-124.95	4.821	77.21	0.065	76.41	0.507	-52.17
1700.0	0.733	-129.64	4.628	71.96	0.071	78.66	0.514	-55.11
1800.0	0.706	-134.46	4.421	67.14	0.076	80.42	0.524	-58.04
1900.0	0.691	-139.12	4.262	61.28	0.083	84.73	0.540	-62.81
2000.0	0.669	-143.06	4.068	56.47	0.089	83.56	0.562	-66.89
2100.0	0.661	-146.80	3.913	51.74	0.100	83.44	0.562	-71.44
2200.0	0.651	-149.92	3.747	47.17	0.112	83.94	0.576	-76.90
2300.0	0.643	-153.50	3.620	43.20	0.123	86.10	0.578	-79.82
2400.0	0.648	-157.16	3.475	38.19	0.136	84.08	0.579	-85.80
2500.0	0.638	-160.05	3.359	34.18	0.146	84.76	0.598	-90.54
2600.0	0.646	-164.22	3.210	30.03	0.164	81.24	0.591	-96.30
2700.0	0.650	-167.02	3.130	26.08	0.176	80.05	0.618	-101.05
2800.0	0.651	-170.84	3.000	21.96	0.193	78.05	0.607	-104.47
2900.0	0.659	-173.51	2.930	18.10	0.211	76.90	0.634	-112.05
3000.0	0.667	-177.55	2.809	13.75	0.225	74.08	0.638	-117.04



### Typical S Parameters

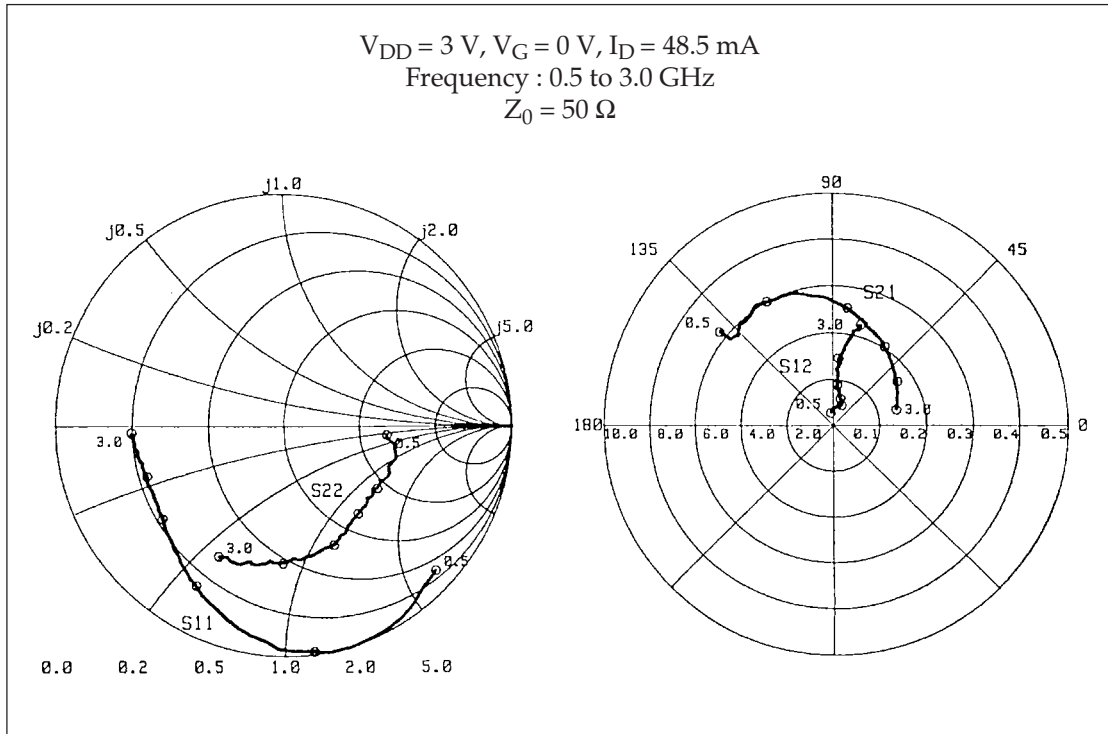

**Test Circuit and Bias Configuration for KGF1262 at 1.9 GHz**

